



Increase building efficiency and economic efficiency with smart technology – LogoMatic G2

- Over 30 years of experience as the market leader in the field of transfer stations
- An intelligence, a product series & > 36,000 product combination possibilities
- High-efficiency hot water preparation & energy savings through the design and mode of operation
- Up to 10% energy savings by avoiding radiated heat losses
- More space gained due to the small installation depth (from 110 mm)
- Time savings due to simple commissioning via the Flamconnect app (including commissioning assistant & automatic commissioning protocol)

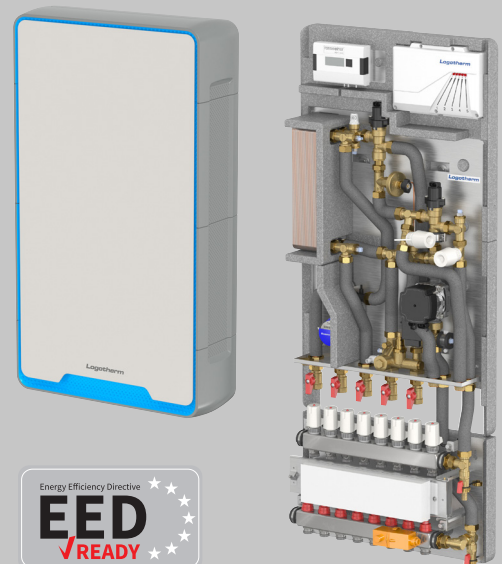

Table of contents

Logotherm – Interface stations	3
Logotherm – The supply concept	4
LogoMatic G2 – Product series	5
LogoMatic G2 – Control type and advantages	6
LogoMatic G2 – Controller & functions	7
LogoMatic G2 – APP & Remote service	8
LogoMatic G2 – Structure & components	9-15
LogoMatic G2 – Complete stations (CS)	16-17
LogoMatic G2 – Ready-to-use stations	18-21
LogoMatic G2 – Complementary products	22-25
LogoMatic G2 – Example product combinations	26-27
LogoMatic G2 – Performance diagrams & tables	28-39





The **Logotherm®** interface station is a complete, ready-to-connect unit. It is simply connected to the heating flow and return lines, the cold water line and the hot water.

The heat interface unit carries out all the functions associated with an independent heating circuit supply and hot water preparation. Depending on the system and application, the hot water output is designed so that several draw-off points can be supplied at the same time. The hot water is prepared via a plate heat exchanger using the continuous flow principle, which complies with the latest hygiene standards because the hot water is prepared on demand without any hot water being stored in large tanks.

The system demonstrates a number of environmental as well as economic benefits. The system is thermally efficient. Renewable energies, such as solar, are easily integrated.

The **Logotherm®** system is flexible and can be adapted to the specific conditions. This means there is a perfectly tailored solution for every requirement - for restoration projects and new builds / as a visible, wall-mounted system, or a practically invisible flush-mounted system.

Ideal for

- Fitting new residential builds with state-of-the-art technology
- Complete renovations of heating systems
- Replacing old gas single-storey heating systems
- Exchange of individual space heaters

In combination with

- Local heating networks and CHP supplies (even in combination with renewable energies)
- Condensing heating systems
- Solar estates
- Heat pumps

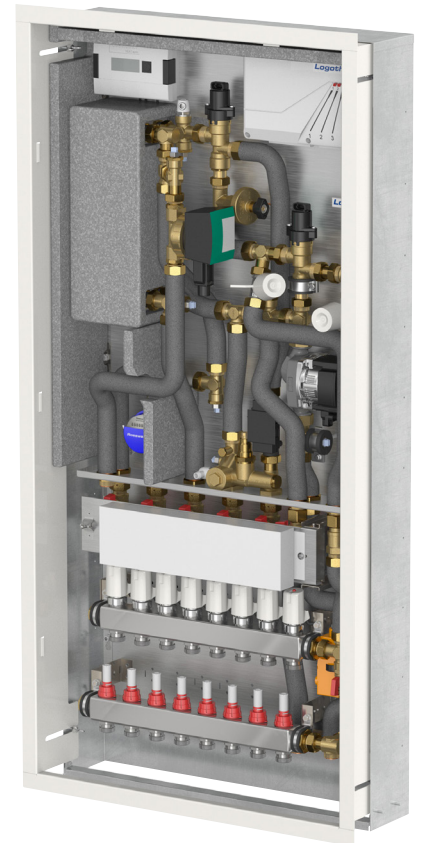

Advantages

- A high quality and safe domestic hot water solution
- Available as wall-mounted and "invisible" flush-mounted variants
- Can be combined with consumption metering (thermal energy and water) for effective billing per residential unit
- Can be used for radiator heating systems and/or mixed heating circuits (underfloor heating)
- Flexible thanks to project-specific and customised configuration options
- Option of simple, customised control of the living space heating
- High level of customer satisfaction
- The regular application of only one heating supply and return line and cold water feed



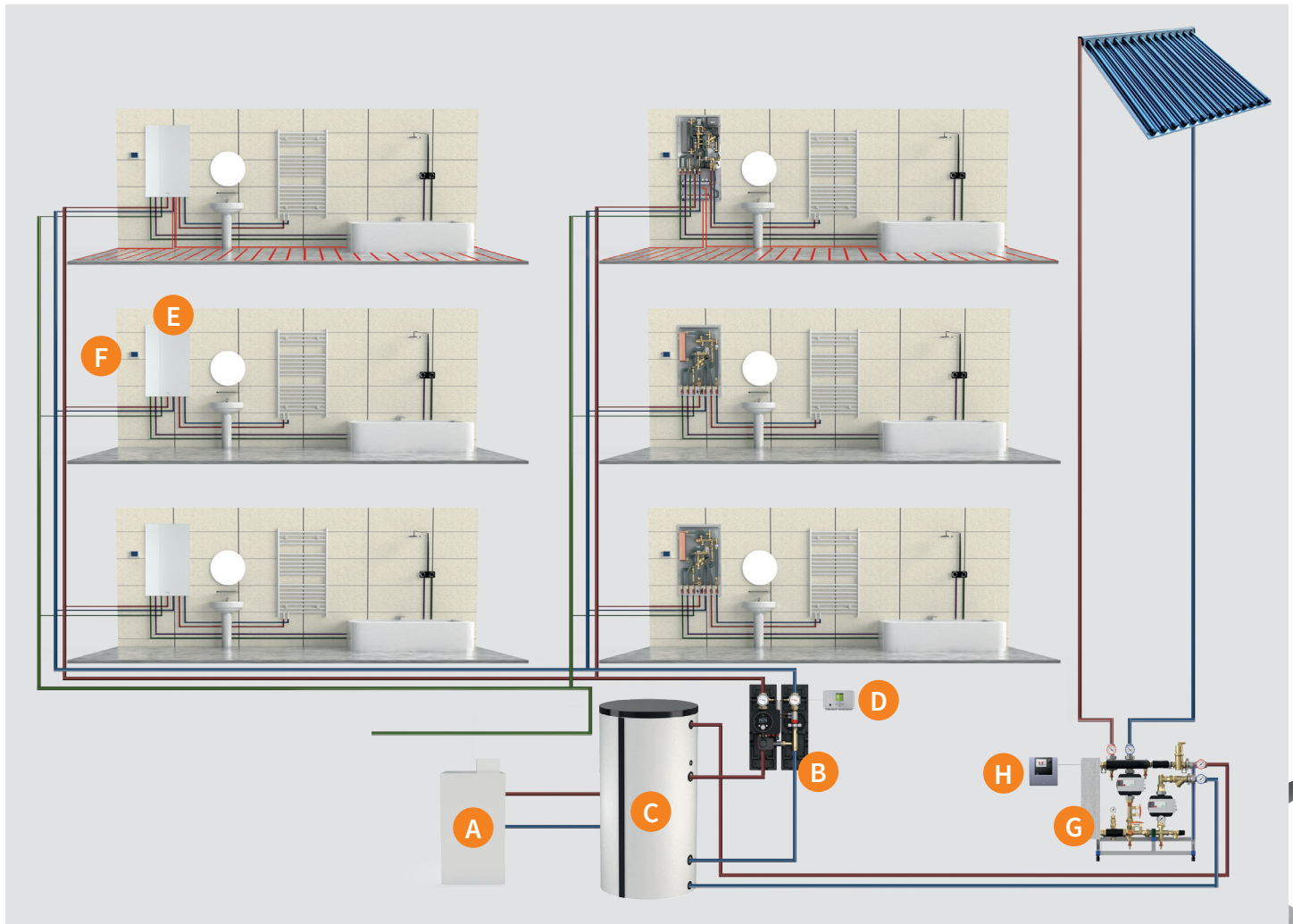

- A** Heat generator
- B** Flamco pump group (e.g. type MeiFlow LFC)
- C** Flamco buffer tank (e.g. type PS 500/PS 600)
- D** Flamco differential pressure-controlled heating circuit controller (e.g. MeiTronic)
- E** Flamco Logotherm® interface station
- F** Flamco dwelling controller (e.g. LogoControl)
- G** Flamco solar separation system (e.g. MeiFlow Sol XL or XXL)
- H** Flamco solar controller (e.g. MeiTronic Sol)



The LogoMatic G2 range is a new generation of highly efficient, compact, plug-and-play, decentralised and wall-mounted thermal interface stations which offer electronically controlled hot water preparation, in line with the latest standards of hygiene, and space heating.

The LogoMatic G2 series has 3 different performance classes of hot water preparation:

- S-Line
- M-Line
- L-Line

Each performance class is available:

- as a ready-to-use station where the complementary products can be freely added.
- with the heating supply
 - an unmixed heating circuit (UC) for radiator heating systems.
 - a mixing circuit (MC) for underfloor heating.
 - combined for both heating systems (MC-UC).
- with or without domestic hot water circulation (DHW-C).
- with a plate heat exchanger
 - copper-welded (CU)
 - sealed (SX)
- for the following types of assembly:
 - As a flush-mounted application (F) using painted steel housing (also optionally available with internal insulation)
 - As a wall-mounted application (S) using painted steel housing
 - As a wall-mounted application (SI) using fully-insulated housing, including white design front panel.

Advantages

Can be combined with:

- different underfloor manifolds from 3 up to 12 mixing circuits.
- another unmixed heating circuit for supplying, for example, a bathroom radiator with a higher primary temperature when using underfloor heating circuits.
- different painted steel housings as wall-mounted and flush-mounted versions as well as a fully-insulated wall-mounted housing with a white design front panel.
- Mounting rails for support in the pre-installation phase as well as the final assembly.
- simple ball valve connection sets.
- a wide variety of consumption metering for consumption metering and warm energy (heat flow meter).
- Pre-wiring packages for the pre-wiring of underfloor manifolds, terminal strips, etc.

The LogoMatic G2 M-Line is also available as a complete station, including different complementary products, such as the ball valve connection set, a wall-mounted or flush-mounted housing and, depending on the type, also with corresponding underfloor manifolds!

EDD ready in connection with the fully-insulated design housing (SI)!





The LogoMatic G2 works with the microprocessor-regulated controller LogoTronic and realises immediate hot water preparation on draw-off thanks to temperature-based regulation of the primary flow rate. Courtesy of its continuously adjustable primary volume flow rate and the associated primary energy capability, the LogoMatic G2 uses the minimum amount of energy required in hot water preparation; depending on the primary network conditions, it can further reduce the return line temperatures, thereby improving the network efficiency of the system as a whole. In addition, a hot water priority switching is integrated in order to achieve a high level of customer comfort.

General advantages

- Only requires low primary pressures.
- Priority switching for hot water preparation for immediate hot water supply.
- Always regulates to the set hot water temperature, regardless of changes in the cold water or primary temperature (e.g. summer / winter operation).
- Regulation via mobile end devices (smartphone, etc.)¹ as well as connection to the GLT^{2 3}.

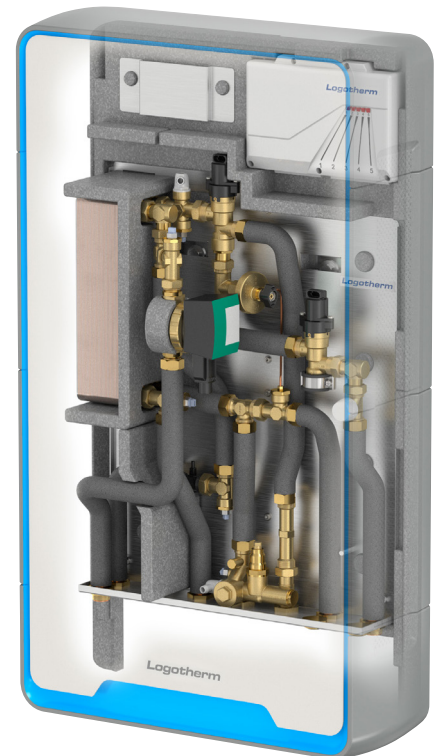

Other features:

- Available as a wall-mounted or “invisible” & space-saving flush-mounted version (from 110 mm installation depth and therefore integration in lightweight walls is possible).
- Ultra-modern due to an electronic control (APP control¹ possible).
- Highly efficient due to the structure, the control type and the EPP full insulation.
- For indirect hot water preparation & direct heating supply.
- High comfort due to the adjustable primary heat-retention function of the station (not via the heat exchanger and measurement circuit of the heat flow meter).
- Option I wireless consumption metering (depending on the type of housing)
- No sensitive moving components in the domestic water area for a high level of operational reliability.
- Optional thermal separation of the cold water connections to reduce the influence of heat on the cold water (in the case of the use of insulation housings and excluding domestic hot water circulation).
- Differential-pressure controlled primary circuit for secondary heating supply.
- Languages stored in the app: NL, DE, EN, FR, SV, RU, PL and CZ

¹ To control the app and generate the interface between the terminal device and the LogoMatic G2, the terminal device must meet the following conditions:
 - Firmware IOS 12 or higher or Android 6 or higher
 - Access possible to the camera via the app
 - Bluetooth 4.0 or Bluetooth LE

² Please have us check the availability and compatibility prior to planning



Control functions & others:

- Adjustable hot water temperatures (30-60°C)
- High-efficiency hot water preparation through the control valve control corresponding to the heat exchanger characteristic curves
- Domestic water circulation with different adjustment and runtime options:
 - After-run function after draw-off
 - Time control stored week programme (including with catch-up function to achieve the daily minimum runtime)
 - External control
- Disinfection circuit of the hot water circuit (only when using a domestic hot water circulation “DHW-C”)
- Frost protection function adjustable
- Profile function (floor screed heating function) with logging and log creation as CSV file.
- Heat demand via a simple ON/OFF switch (e.g. From the reference room controller) via a potential-free contact
- Heat demand & control regarding the temperature and time as well as the weather-dependent heating circuit controller (through stored heating curves) via:
 - a 0-10V control
 - via Opentherm^{2,3}
 - connectable outside temperature sensor
- Anti-blocking function of the mixing circuit pump
- Control via APP¹ and connection via Bluetooth to implement a simple commissioning via the commissioning assistant in order to update the firmware, etc.
- Automatic receipt of a commissioning report indicating the settings as CSV file
- Internal data storage (including alarm and fault message output) in real time
- Visualisation of the operating state via LEDs on the controller for a simplified system monitoring
- 2 control buttons on the controller (for firmware updates & tests)

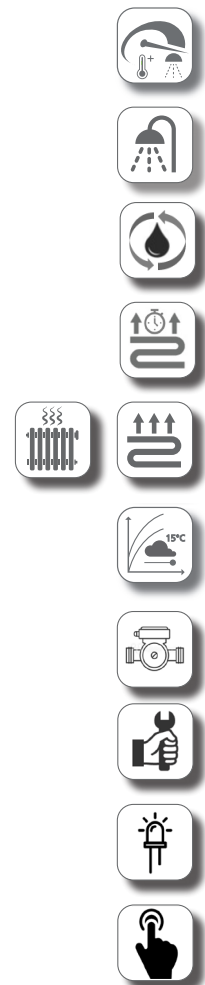

Memory, interfaces & communication:

- Bluetooth¹
- Internal memory 1 MB
- Alarm and fault message output
- RS485 for the connection of a local laptop & for data communication via MOD bus (HFC protocol)^{2,3}
- USB interface for up to 32GB external memory³
- Data communication to the HFC cloud via a separate gateway for operational data provision³
- M-BUS master to connect up to 4 consumption metering devices for the remote read-out of data, automatic warning messages, remote troubleshooting and preventative maintenance³

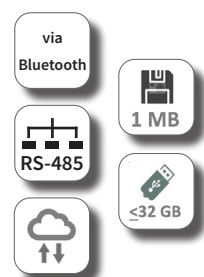

¹ To control the app and generate the interface between the terminal device and the LogoMatic G2, the terminal device must meet the following conditions:

- Firmware IOS 12 or higher or Android 6 or higher
- Access possible to the camera via the app
- Bluetooth 4.0 or Bluetooth LE

² Please have us check the availability and compatibility prior to planning

³ In planning (check availability beforehand)

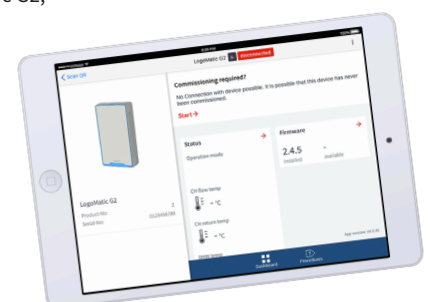



Use the "FlamConnect ST" app for a simple commissioning and service of the LogoMatic G2. It allows the user to quickly and easily connect with the LogoMatic G2 via Bluetooth by scanning the QR code and then guides the user through the individual steps. The user simply follows the described steps and at the end receives a digital commissioning report.

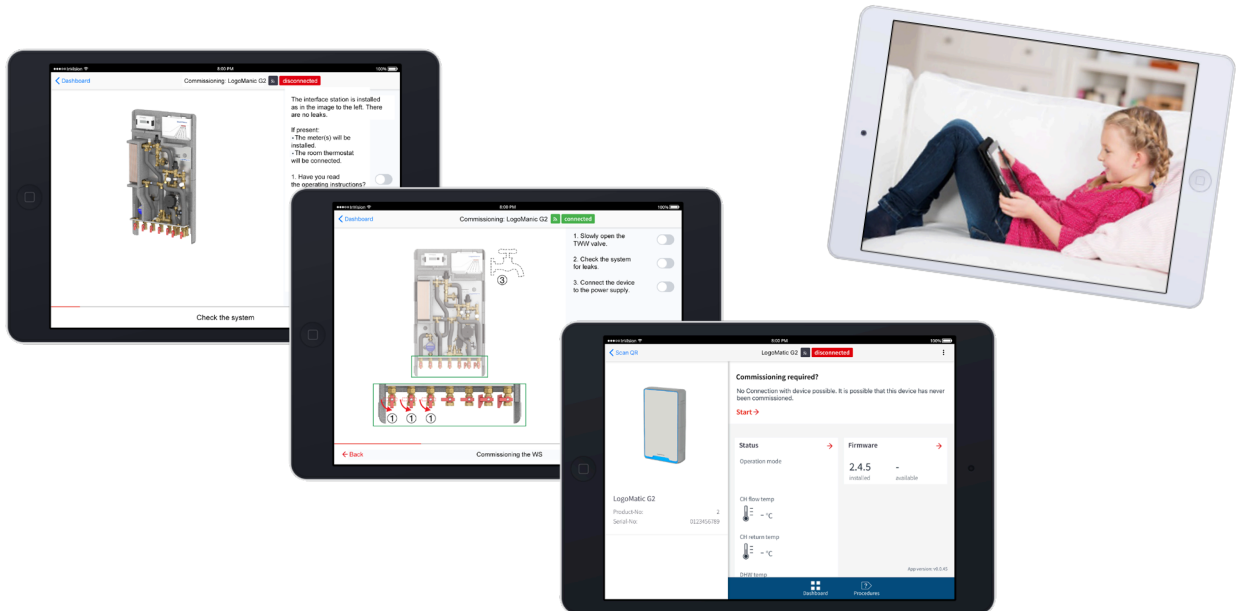

The settings are set via selection field or using a slider in the app!

After successfully making the settings, the user is guided to the next step by confirming the settings.

Flamconnect – On app for many Flamco products

Flamconnect gives building owners, installers and service technicians a simple way of making product settings and gives them an overview of all connected devices of the newer generation of Flamco Meibes. If maintenance is pending or a fault occurs, a message is sent out. Due to the stored system information, technicians can already see before the appointment whether a part needs to be replaced, for example, and go to the customer appropriately prepared.

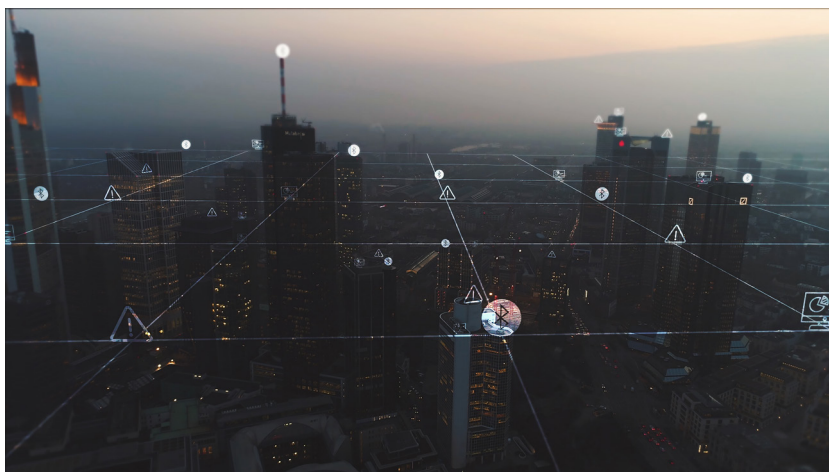



Example product code:¹

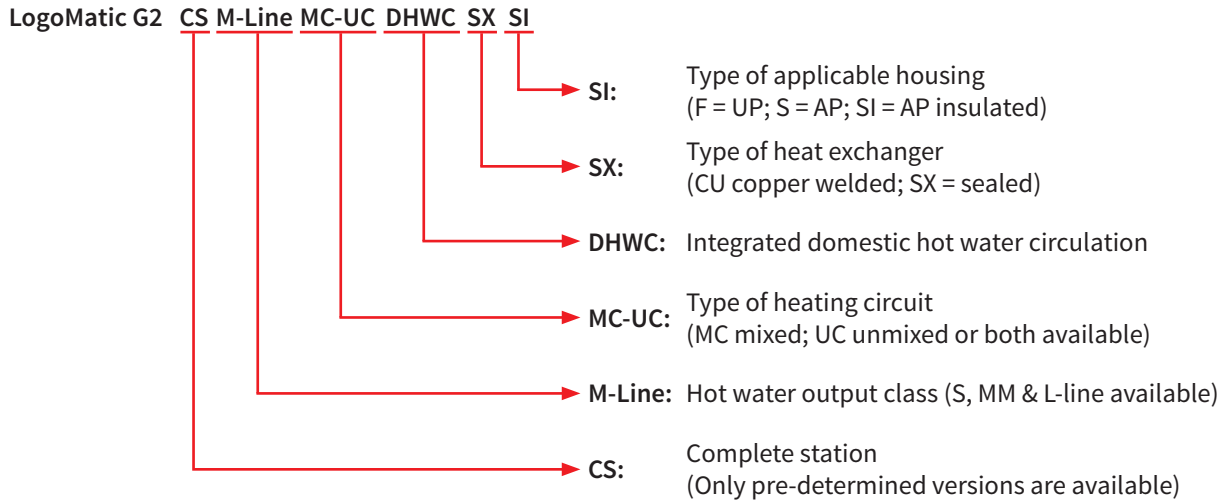

Flow charts of the following types of stations:

LogoMatic G2 UC DHWC
(Unmixed heating circuit as well as domestic hot water circulation)

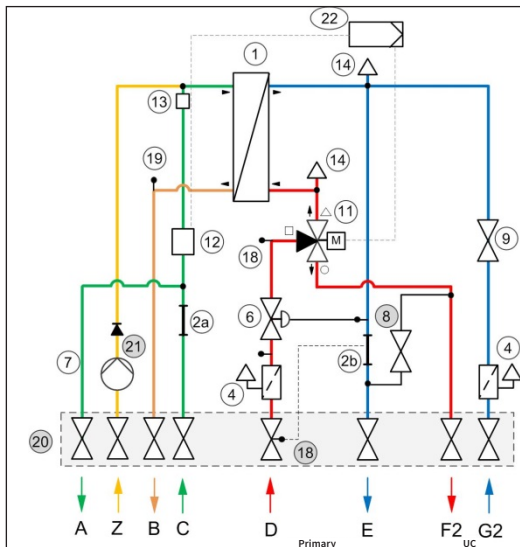

LogoMatic G2 MC-UC DHWC
(Unmixed & mixed heating circuit as well as domestic hot water circulation)

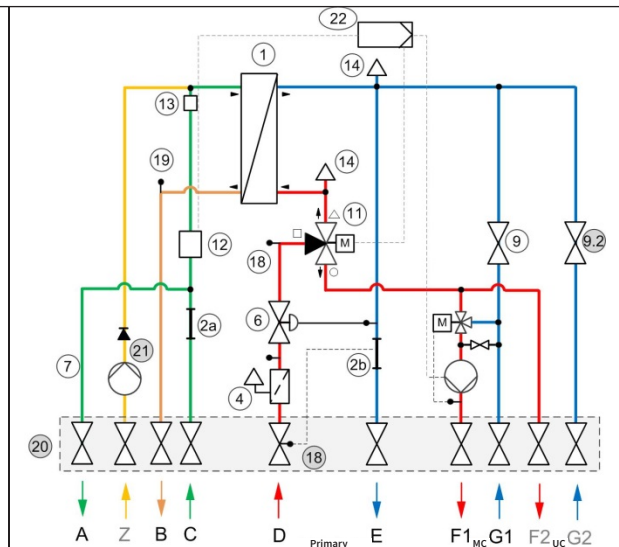

Legend: Connections 3/4" AG (without optional ball valves)		UC	MC	UC-MC
A	Cold water outlet for dwelling, (second CW connection)	A	A	A
B	Domestic hot water outlet for dwelling (HW)	B	B	B
C	Cold water inlet building connection (CW)	C	C	C
D	Heating flow line building connection (SL heating)	D	D	D
E	Heating return line building connection (RL heating)	E	E	E
F1/F2	Heating flow line dwelling heating circuit (SL dwelling), F1-MK / F2-UK	F2	F1	F1/F2
G1/G2	Heating return line dwelling heating circuit (RL dwelling), G1-MK / G2-UK	G2	G1	G1/G2
Z	Domestic hot water circulation Z (optional)	-	Z	Z

¹Example product code. This product combination is not necessarily possible.

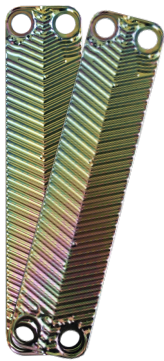

Heat exchanger

We offer copper-welded and coated plate heat exchangers for the LogoMatic G2. The difference of the two types lies in their resistance with regard to media quality. This type of coating is used, among other places, in the food industry (e.g. in drinking bottles) to reduce possible biofouling through a smoother and more homogeneous surface. In addition, the risk of deposits, quick blockages and germination of microbiology between the channels of the plates is reduced.

Actuators and control valves



The high response speed of the actuators (step motors with 240 positions) combined with the control valves is ideal for use in such a sensitive area as domestic hot water heaters and the high comfort requirements here. These actuators are used, among other places, in the automotive industry and are used there with their very fast response time for safety-related areas, such as headlights (adaptive curve light). The valves are controlled with a priority switching for the hot water preparation and thus provide a quick provision of hot water for the draw-off and thus for a high level of customer comfort.

In addition, algorithms stored in the LogoMatic G2 control unit optimize the operation and control the control valves along the heat exchanger characteristic curve, which increases the response time even more.

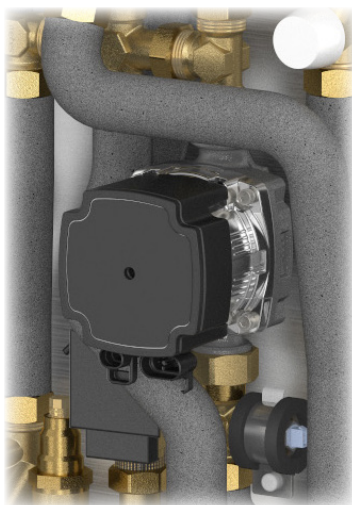

Heating system controller

The heating system can be controlled via different controls (ON/OFF switch, 0-10 V, Opentherm) and settings (fixed value, weather-controlled, etc.).

The mixing circuit pump is controlled by the LogoMatic G2 controller via PWM signal. In addition to the advantage of energy savings due to the frequency control, there is the advantage that the speed and any occurring error messages of the pump are transmitted to the control unit.

In addition, there is an anti-blocking function in the control technology to allow for the mixing circuit pump to start up even after longer downtimes.



Tests for response speed & efficiency

The LogoMatic G2 series is tested using available test methods on the market (“BESA” as well as “Noun” test methods) in order to meet all claims for efficiency and comfort.

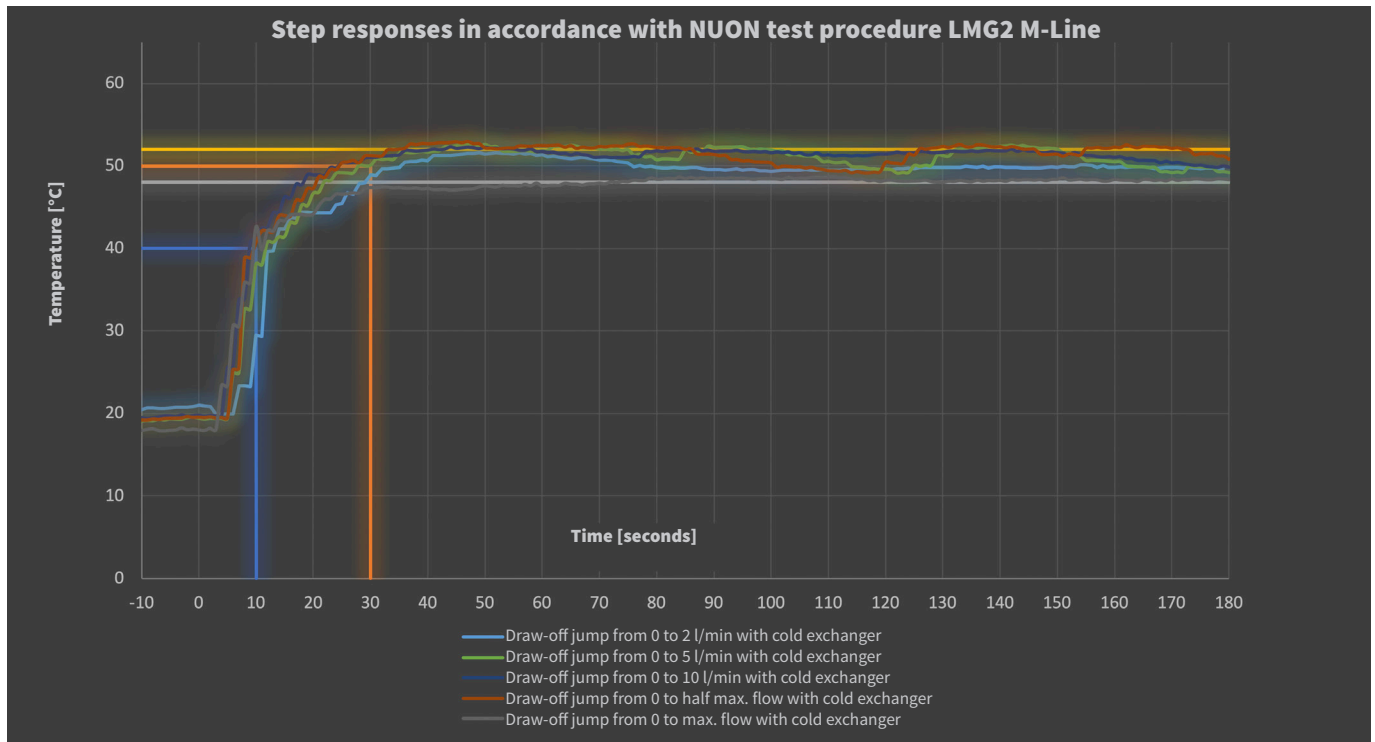
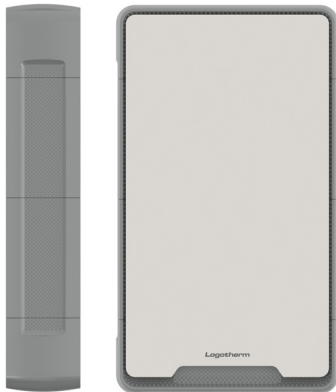

Diagram example of a test of a LogoMatic G2 according to the NOUN test requirements.



Housing & insulation



The available wall-mounted design housing for the LogoMatic G2 is a multi-shell insulation housing and combines a beautiful design, which can be integrated into any room and its furnishings, with the functionality of an energy-efficient insulation. The insulation is 30 mm thick with a thermal conductivity of 0.036 W/m*K and thus, in addition to achieving the highest possible energy and cost efficiency (by reducing heat radiation), offers the ability to comply with country-specific specifications regarding the insulation of products and components for hot water preparation and heat supply.

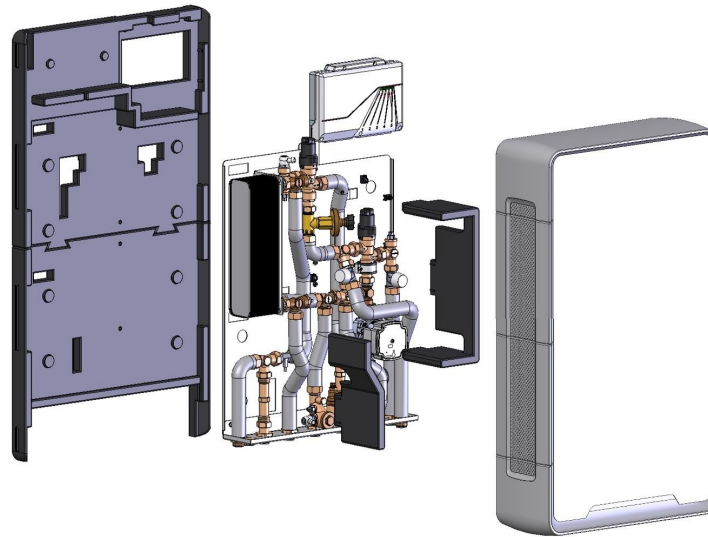

Moreover, however, there are wall-mounted and flush-mounted housings made of painted steel (RAL9016) in which the LogoMatic G2 can be integrated (see “Complementary products” for descriptions of these).

There is an insulation for the flush-mounted housing that can also optionally be integrated in order to also realize an even more efficient operation with the flush-mounted version.

Using insulation housings or insulation that can be integrated makes it possible to realize energy savings of up to 10%. Here is an example visualisation of the heat radiation for a flush-mounted housing with additional integrated insulation [Fig. 1] and without an additionally integrated insulation [Fig. 2], each with a runtime of the hot water preparation and heating supply of 30 min!

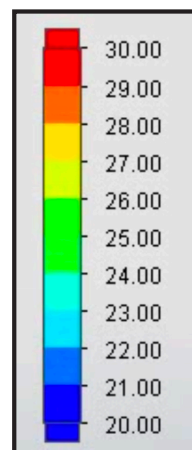

Temperature (Solid) [°C]

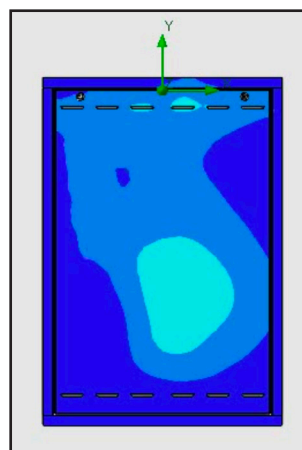

Fig. 1

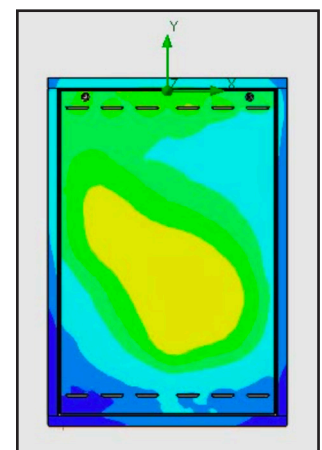
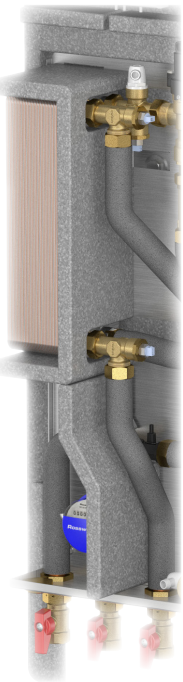

Fig. 2



In addition, the wall-mounted design housing as well as the use of the inner insulation for flush-mounted housing allows a thermal separation of the domestic cold water area (before the supply to the hot water preparation) from the domestic hot water and the heating part (excluding the domestic hot water circulation). This largely avoids the domestic cold water from heating up and reduces a resulting risk of germination of microbiology (e.g. Legionella) in the domestic cold water area. Here is an example visualisation of the heat transfer and distribution for a flush-mounted housing with additional integrated thermal separation (insulation) [Fig. 1] and without integrated thermal separation (insulation) [Fig. 2]!

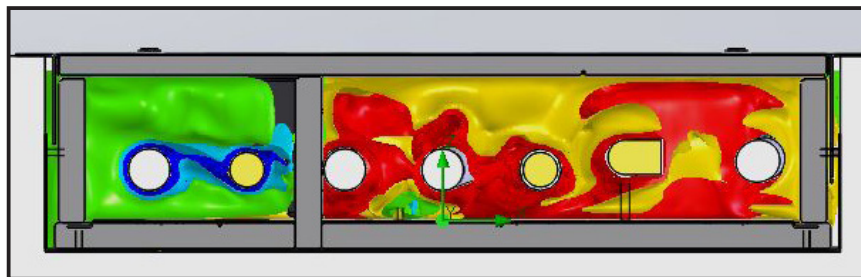

Fig. 1

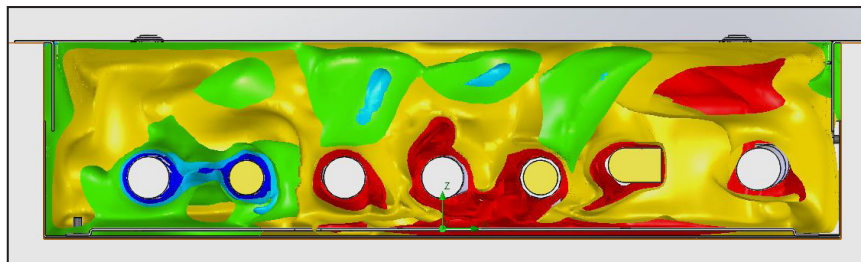
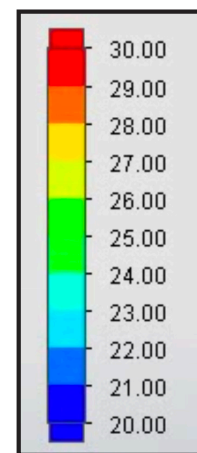

Fig. 2



Temperature (Fluid) [°C]

The wall-mounted design housing, but also the alternative wall-mounted or flush-mounted housing of painted steel with plastic insert (see under “Wireless” in the product description) offer a wireless transmission and are therefore “EED ready”¹, whereby a wireless-ready consumption metering can also be easily used.



¹Energy-Efficient Directive (entered into force on 24 December 2018)



The “Safety trap”

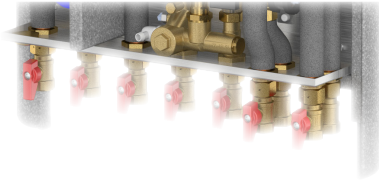

Water may escape during installation work (e.g. when installing consumption metering, such as hot flow meters or water meters) as well as during service work. The “Safety trap” was installed in the LogoMatic G2 series to obtain the best possible protection from influences of escaping water. It makes it possible to collect a certain amount of water. Moreover, a moisture sensor can be used in the “safety trap” depending on the installation size.

Multifunctional

The integrated multifunctional component makes it possible to achieve a space-saving installation and enables 5 integrated functions.

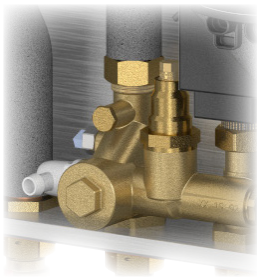

1. Pre-filter to protect the LogoMatic G2 in the primary flow line.
2. Sensor receptacle in M10 to allow the possible use of the flow line sensor from the heat flow meter.
3. The adjustable heat-retention function (35 to 65°C) in the primary circuit for a high response speed when heat is requested for the hot water preparation or the heating supply.
4. Sensor receptacle for controlling the LogoMatic G2 directly at the inlet of the primary flow line and resulting high response speed of the control technology.
5. Emptying function with hose connection for easy service.

Flow sensor

The integrated flow meter has a low start-up threshold, whereby the hot water preparation runs without interruption already at a low draw-off volume (working range of the flow meter 1 to 30 l/min.) of the water to be heated.

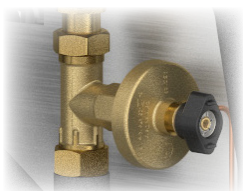

Differential pressure regulator

An adjustable differential pressure regulator is integrated to ensure an efficient network operation and to avoid over- and undersupply.



Technical equipment and functional description of the LogoMatic G2

	Ready-to-use units			Complete stations (CS)		
	UC	MC	MC-UC	UC	MC	MC-UC
Microprocessor-controlled controller (230V, 50 Hz) with status displays at the station, parameter protection, anti-frost protection, commissioning assistant, alarm & fault message display, real-time clock for a high level of accuracy, APP *1-based setting possibility, display possibility of all sensor values as well as the control of all actuators and checking the sensors via the APP *1	✓	✓	✓	✓	✓	✓
Pre-set draw-off temperature of the hot water 50°C (recommendation DVGW W551) - setting range 30-60°C ³	✓	✓	✓	✓	✓	✓
Radiator heating circuit supply, unmixed heating circuit (UC)	✓	-	✓	✓	-	✓
Mixer circuit (MC) with injection circuit (adjustment range 20-65°C) ³ through electronically quick & constantly adapting control valve and high-efficiency pump (anti-blocking function)	-	✓	✓	-	✓	✓
Underfloor manifold with 6 outlet pieces (3/4" M Euro cone, 0.5- 5l /min., 6 bar)	Option	Option	Option	-	✓	-
Underfloor manifold with 8 outlet pieces (3/4" M Euro cone, 0.5- 5l /min., 6 bar)	Option	Option	Option	-	-	✓
Electronically quick & constantly adapting control valve with control-technology priority switching for the hot water preparation	✓	✓	✓	✓	✓	✓
Directly immersed sensor for a high responsiveness and efficiency	✓	✓	✓	✓	✓	✓
Achievable low return line temperatures during hot water preparation through electronically regulating the primary energy supply (depending on the primary conditions)	✓	✓	✓	✓	✓	✓
Controllable heating mode using external control (potential-free control of 230 V as ON/OFF circuit)	✓	✓	✓	✓	✓	✓
Controllable heating mode using external control (0-10V as modulating controller)	✓	✓	✓	✓	✓	✓
Weather-controlled heating circuit controller (stored heating curve) ³	-	✓	✓	-	✓	✓
Exact volume-based hot water preparation using robust turbine flow meter (1-30 l/min.)	✓	✓	✓	✓	✓	✓
Stainless-steel plate heat exchanger, vertical design to reduce the risk of calcification	✓	✓	✓	✓	✓	✓
Control valve for heating (zone valve for connection to living space controller)	✓	✓	✓	✓	✓	✓
Automatic air vent with hose connection on the heating side	✓	✓	✓	✓	✓	✓
Adaptor for heat flow meter 3/4" x 110 mm as well as sensor receptacle (M10x1)	✓	✓	✓	✓	✓	✓
Energy-saving due to pipework made of insulated stainless steel corrugated tube	✓	✓	✓	✓	✓	✓
Mounted on base plate, with absolutely no mechanical stress, and inspected	✓	✓	✓	✓	✓	✓
Dirt trap with stainless steel strainer insert for a high level of operational reliability	✓	✓	✓	✓	✓	✓
Second cold water connection for residential building	✓	✓	✓	✓	✓	✓
Cold water meter adaptor 3/4" x 110 mm	✓	✓	✓	✓	✓	✓
Heat-retention function of the primary hot water supply (not via the measurement circuit of the WMZ) via an adjustable circulation bridge (35-65 °C)	✓	✓	✓	✓	✓	✓
Differential pressure regulator (control range 5-25 kPa)	✓	✓	✓	✓	✓	✓
Volumetric flow limiter for the hot water volume control ⁴	✓	✓	✓	✓	✓	✓
7 ball valves DN 20 (TW ball valves DVGW-tested)	Option	Option	Option	✓	✓	✓
Adjustable screed heating function	-	✓	✓	-	✓	✓
Internal data storage with log function	✓	✓	✓	✓	✓	✓
Domestic hot water circulation (including insulation of the heat exchanger) with different adjustable control options (time window, DVGW-compliant, etc.) ³ and datalogging as well as possible disinfection mode	"DHW-C" Version	"DHW-C" Version	"DHW-C" Version	-	-	-
Housing as wall-mounted housing (insulated with white front cover) - SI version	Option	Option	Option	SI or F	SI or F	SI or F
Housing as wall-mounted housing (steel painted white) - S version	Option	Option	Option	-	-	-
Housing as flush-mounted housing (steel painted white) - F version	Option	Option	Option	SI or F	SI or F	SI or F

* To control the app and generate the interface between the terminal device and the LogoMatic G2, the terminal device must meet the following conditions

- Firmware IOS = 12 or higher
- Firmware Android = 6 or higher
- Access possible to the camera via the app
- Bluetooth 4.0 or Bluetooth LE

¹⁾ Use of the Flamconnect app and connection via Bluetooth. Check the terminal device suitability in advance.

²⁾ Width: dimension of front cover, cut-out dimension greater. Height: dimension of front cover, or adjustable in height. Feet. Depth: adjustable.

³⁾ Preset values can be changed via the existing app if necessary.

⁴⁾ Except for the version L-Line.



The LogoMatic G2 CS M-Line complete stations are compact, plug-and-play, wall-mounted, decentralised heating interface units in which the hot water preparation and heating of the living space are electronically controlled according to volume. They include the housing and ball-valve connection kit, enabling quick selection and delivery, and easy handling.

The LogoMatic G2 CS is available with a static heating circuit (UC variant), with a direct mixing circuit as well as 6 underfloor manifolds (6MC variant) or with a direct mixing circuit as well as 8 underfloor manifolds and a second static heating circuit (8MC-UC variant).

LogoMatic G2 CS complete stations are available as wall-mounted (AP) or flush-mounted (UP) versions, with copper-brazed heat exchangers (CU) or sealed (SX) heat exchangers.

Technical data	Complete stations (CS)		
	UC	MC	MC-UC
Wall-mounted version: Width [mm]	600	600	600
Wall-mounted version: Height [mm]	1.050	1.375	1.375
Wall-mounted version: Depth [mm]	220	220	220
Flush-mounted version: Width [mm]	610 ²	610 ²	610 ²
Flush-mounted version: Height [mm]	935 ²	1.300 ²	1.300 ²
Flush-mounted version: Depth [mm]	110-160 ²	130-210 ²	130-210 ²
Bottom connections	3/4" F	3/4" F	3/4" F
Max. nominal pressure load: Heating (prim. & sec.) as well as plumbing	PN10	PN10	PN10
Min. differential pressure (heating on primary side)	0.03 bar	0.03 bar	0.03 bar
Max. differential pressure (heating on primary side)	2.5 bar	2.5 bar	2.5 bar
Max. temperature load: Heating (prim. & sec.) as well as plumbing	100°C	100°C	100°C

Complete stations												
Type		Heating system type	TWZ	Heat exchanger	Type of assembly			WW-Output l/min / kW	Fig. ³	Order no.		
					UP	AP	AP insul.			For heat exchanger		
					copper-brazed		sealed					
LM G2	M-Line	CS	UC	-	CU or SX	-	-	SI	16.1 / 39.3 ^{2.1} 17.0 / 41.5 ^{2.2} 17.0 / 47.4 ^{2.3}	1	M11114.1HKAP	M11114.1HKAPSX
LM G2	M-Line	CS	UC	-	CU or SX	F	-	-		2	M11114.1HKUP	M11114.1HKUPSX
LM G2	M-Line	CS	6MC	-	CU or SX	-	-	SI		3	M11114.61MKAP	M11114.61MKAPSX
LM G2	M-Line	CS	6MC	-	CU or SX	F	-	-		4	M11114.61MKUP	M11114.61MKUPSX
LM G2	M-Line	CS	8MC-UC	-	CU or SX	-	-	SI		3	M11114.81MKAP	M11114.81MKAPSX
LM G2	M-Line	CS	8MC-UC	-	CU or SX	F	-	-		4	M11114.81MKUP	M11114.81MKUPSX

¹⁾ Dimensions specified are of the station only without the housing. Housing dimensions can be found in the housing description

²⁾ Width: dimension of front cover, cut-out dimension greater.

Height: Dimensions of the front cover, without height-adjustable feet.

Depth: Adjustable.

^{2.1)} Defined for a flow line temperature of 55°C and a heating by 35 K.

^{2.2)} Defined with a flow line temperature of 65°C and heating of 40 K.

^{2.3)} Defined with a flow line temperature of 65°C and heating of 35 K.



Fig. 1: LogoMatic G2 M-Line CS-UC-SI

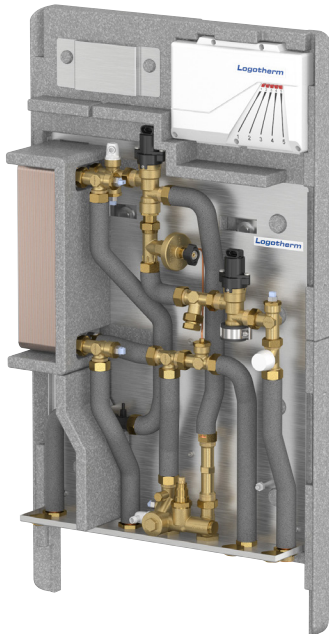

Fig. 3: LogoMatic G2 M-Line CS-8MC-UC-SI

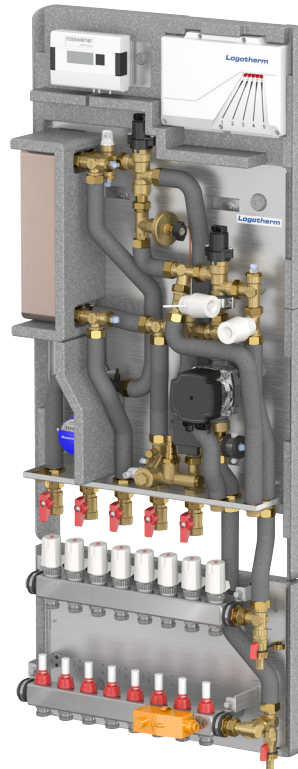

Fig. 2: LogoMatic G2 M-Line CS-MC-F

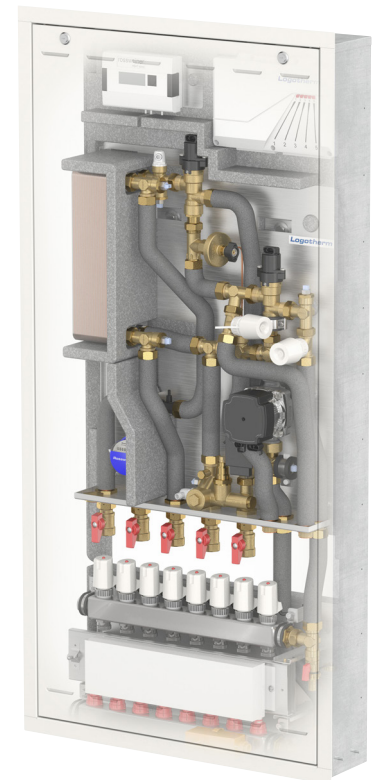

Fig. 4: LogoMatic G2 M-Line CS-8MC-UC-F

CS = Complete stations, UC = unmixed heating circuit, MC = mixed heating circuit, F or UP = flush-mounted version, S or AP = wall-mounted version, SI or AP insul. = wall-mounted version for insulated housing, DHWC = domestic hot water circulation; CU = copper-brazed plate heat exchanger, SX = sealed, copper-brazed plate heat exchanger

¹ Optionally available with an internal housing insulation.

^{2.1} Defined for a flow line temperature of 55°C and a heating by 35 K.

^{2.2} Defined with a flow line temperature of 65°C and heating of 40 K.

^{2.3} Defined with a flow line temperature of 65°C and heating of 35 K.

³ All figures are similar to the real model. The kit and scopes of supply may differ. The scope of supply can be found in the product description.



LogoMatic G2 – Ready-to-use stations

The ready-to-use stations of the LogoMatic G2 can be combined with a variety of complementary products in order to meet all project and comfort needs.

A combination example of a LogoMatic G2 with an unmixed heating circuit (UC) and a mixed heating circuit (MC) with up to 8 mixing circuit outlet pieces for up to 600 mm wide LogoMatic G2 versions (example representation as wall-mounted version with insulated housing).

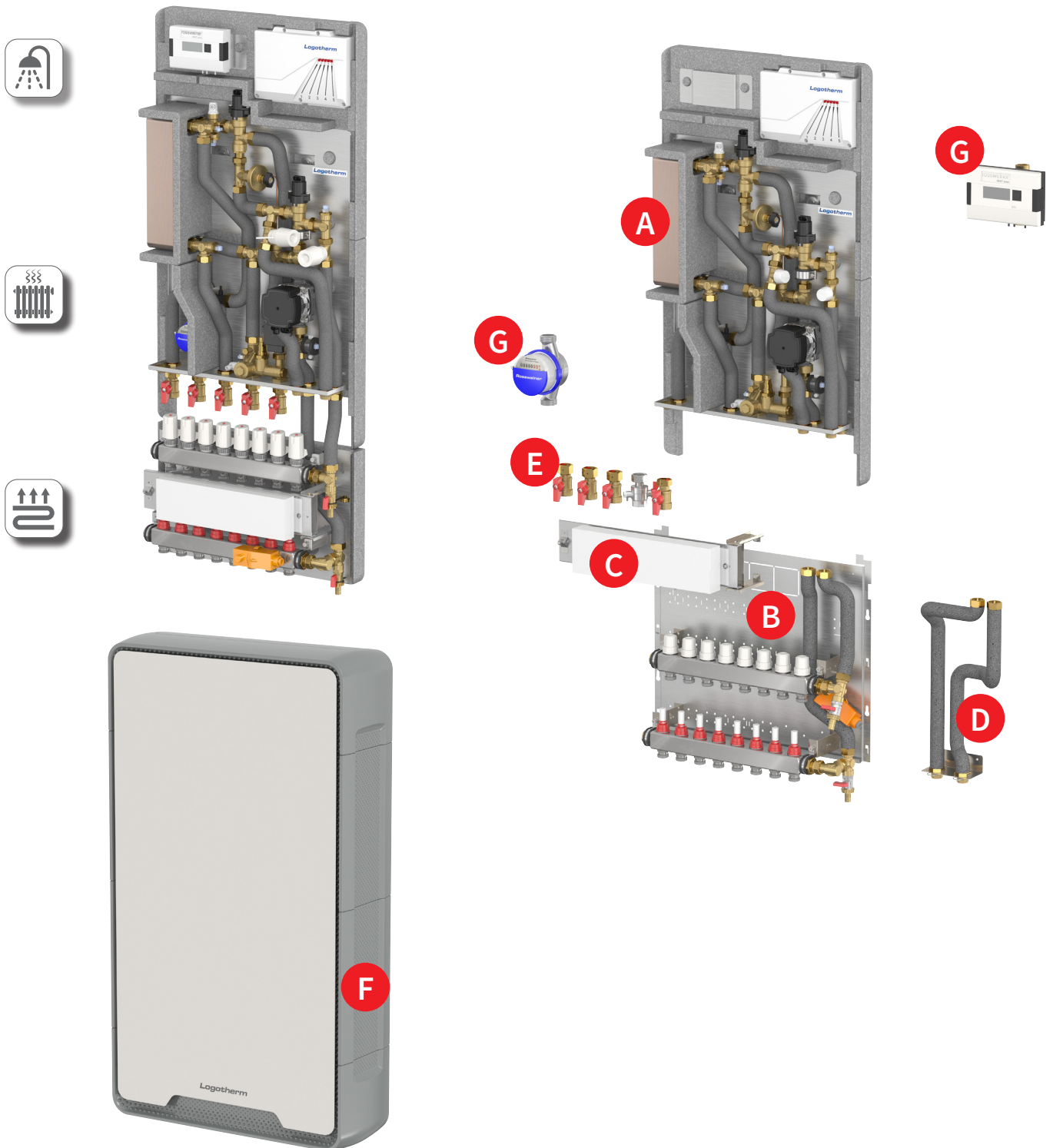

LogoMatic G2 – Ready-to-use stations



A combination example of a LogoMatic G2 with an unmixed heating circuit (UC) and a mixed heating circuit (MC) with up to 12 mixing circuit outlet pieces for up to 850 mm wide LogoMatic G2 versions (example representation as flush-mounted version).

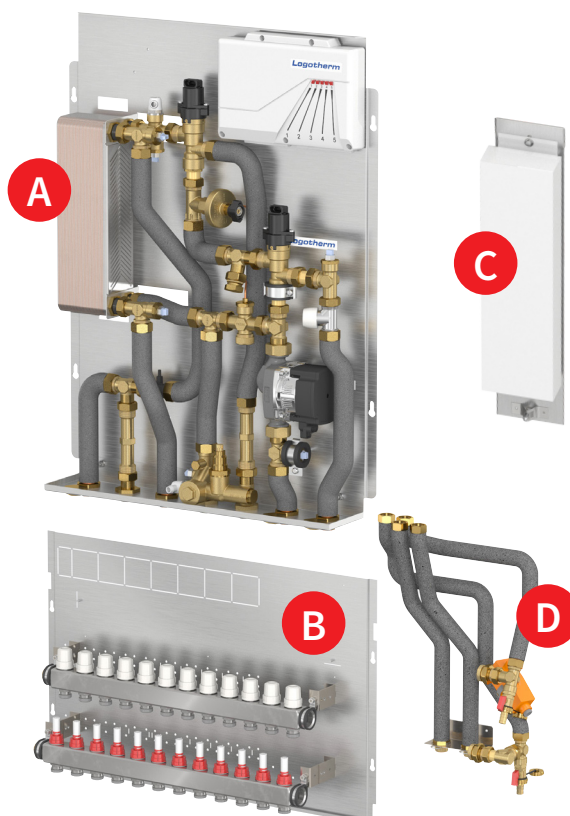
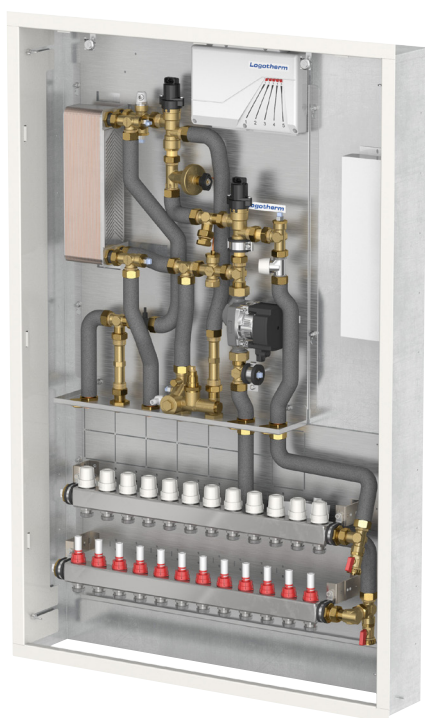



The ready-to-use stations of the LogoMatic G2 are compact, ready-to-connect, decentralised interface stations with electronically-controlled hot water preparation and heating of the living space as a system of the wall-mounted installation with the option to add additional different complementary products.

Technical data	Ready-to-use units		
	UC	MC	MC-UC
Wall-mounted version: Width [mm]	500 ¹	500 ¹	500 ¹
Wall-mounted version: Height [mm]	760 ¹	760 ¹	760 ¹
Wall-mounted version: Depth [mm]	115 ¹	115 ¹	115 ¹
Flush-mounted version: Width [mm]	576 ¹	576 ¹	576 ¹
Flush-mounted version: Height [mm]	775 ¹	775 ¹	775 ¹
Flush-mounted version: Depth [mm]	110 ¹	110 ¹	110 ¹
Bottom connections	3/4" M	3/4" M	3/4" M
Max. nominal pressure load: Heating (prim. & sec.) as well as plumbing	PN10	PN10	PN10
Min. differential pressure (heating on primary side)	0.03 bar	0.03 bar	0.03 bar
Max. differential pressure (heating on primary side)	2.5 bar	2.5 bar	2.5 bar
Max. temperature load: Heating (prim. & sec.) as well as plumbing	100°C	100°C	100°C

¹ Dimensions specified are of the station only without the housing. Housing dimensions can be found in the housing description in the chapter "Complementary products"

Ready-to-use units												
Type		Heating system type	TWZ	Type of assembly			Hot water output l/min / kW	Fig. ³	Order no.			
				UP ¹	AP	AP insul.			For heat exchanger			
						copper-brazed	sealed					
LM G2	S-Line	-	UC	-	F	S	-	12.0 / 29.3 ^{2.1}	1	M1114.4	M1114.402	
LM G2	S-Line	-	MC	-	F	S	-	12.0 / 29.3 ^{2.2}	2	M1114.5	M1114.502	
LM G2	S-Line	-	MC-UC	-	F	S	-	12.0 / 33.4 ^{2.3}		M1114.6	M1114.602	
LM G2	M-Line	-	UC	-	F	S	-	16.1 / 39.3 ^{2.1}	1	M1114.41	M1114.412	
LM G2	M-Line	-	MC	-	F	S	-	17.0 / 41.5 ^{2.2}	2	M1114.51	M1114.512	
LM G2	M-Line	-	MC-UC	-	F	S	-	17.0 / 47.4 ^{2.3}		M1114.61	M1114.612	
LM G2	L-Line	-	UC	-	F	S	-	22.0 / 53.7 ^{2.1}	1	M1114.42	M1114.422	
LM G2	L-Line	-	MC	-	F	S	-	22.0 / 53.7 ^{2.2}	2	M1114.52	M1114.522	
LM G2	L-Line	-	MC-UC	-	F	S	-	22.0 / 61.3 ^{2.3}		M1114.62	M1114.622	
LM G2	S-Line	-	UC	-	-	-	SI	12.0 / 29.3 ^{2.1}	3	M1114.43	M1114.432	
LM G2	S-Line	-	MC	-	-	-	SI	12.0 / 29.3 ^{2.2}		M1114.53	M1114.532	
LM G2	S-Line	-	MC-UC	-	-	-	SI	12.0 / 33.4 ^{2.3}	4	M1114.63	M1114.632	
LM G2	M-Line	-	UC	-	-	-	SI	16.1 / 39.3 ^{2.1}	3	M1114.44	M1114.442	
LM G2	M-Line	-	MC	-	-	-	SI	17.0 / 41.5 ^{2.2}		M1114.54	M1114.542	
LM G2	M-Line	-	MC-UC	-	-	-	SI	17.0 / 47.4 ^{2.3}	4	M1114.64	M1114.642	
LM G2	L-Line	-	UC	-	-	-	SI	22.0 / 53.7 ^{2.1}	3	M1114.45	M1114.452	
LM G2	L-Line	-	MC	-	-	-	SI	22.0 / 53.7 ^{2.2}		M1114.55	M1114.552	
LM G2	L-Line	-	MC-UC	-	-	-	SI	22.0 / 61.3 ^{2.3}	4	M1114.65	M1114.652	
LM G2	S-Line	-	UC	DHWC	F	S	-	12.0 / 29.3 ^{2.1}		M1114.401	M1114.403	
LM G2	S-Line	-	MC	DHWC	F	S	-	12.0 / 29.3 ^{2.2}		M1114.501	M1114.503	
LM G2	S-Line	-	MC-UC	DHWC	F	S	-	12.0 / 33.4 ^{2.3}	5	M1114.601	M1114.603	
LM G2	M-Line	-	UC	DHWC	F	S	-	16.1 / 39.3 ^{2.1}		M1114.411	M1114.413	
LM G2	M-Line	-	MC	DHWC	F	S	-	17.0 / 41.5 ^{2.2}		M1114.511	M1114.513	
LM G2	M-Line	-	MC-UC	DHWC	F	S	-	17.0 / 47.4 ^{2.3}	5	M1114.611	M1114.613	
LM G2	L-Line	-	UC	DHWC	F	S	-	22.0 / 53.7 ^{2.1}		M1114.421	M1114.423	
LM G2	L-Line	-	MC	DHWC	F	S	-	22.0 / 53.7 ^{2.2}		M1114.521	M1114.523	
LM G2	L-Line	-	MC-UC	DHWC	F	S	-	22.0 / 61.3 ^{2.3}	5	M1114.621	M1114.623	
LM G2	S-Line	-	UC	DHWC	-	-	SI	12.0 / 29.3 ^{2.1}	6	M1114.431	M1114.433	
LM G2	S-Line	-	MC	DHWC	-	-	SI	12.0 / 29.3 ^{2.2}		M1114.531	M1114.533	
LM G2	S-Line	-	MC-UC	DHWC	-	-	SI	12.0 / 33.4 ^{2.3}	7	M1114.631	M1114.633	
LM G2	M-Line	-	UC	DHWC	-	-	SI	16.1 / 39.3 ^{2.1}	6	M1114.441	M1114.443	
LM G2	M-Line	-	MC	DHWC	-	-	SI	17.0 / 41.5 ^{2.2}		M1114.541	M1114.543	
LM G2	M-Line	-	MC-UC	DHWC	-	-	SI	17.0 / 47.4 ^{2.3}	7	M1114.641	M1114.643	
LM G2	L-Line	-	UC	DHWC	-	-	SI	22.0 / 53.7 ^{2.1}	6	M1114.451	M1114.453	
LM G2	L-Line	-	MC	DHWC	-	-	SI	22.0 / 53.7 ^{2.2}		M1114.551	M1114.553	
LM G2	L-Line	-	MC-UC	DHWC	-	-	SI	22.0 / 61.3 ^{2.3}	7	M1114.651	M1114.653	



Fig. 1: LogoMatic G2 UC-F/S

Fig. 2: LogoMatic G2 MC-F/S

Fig. 3: LogoMatic G2 UC-SI

A

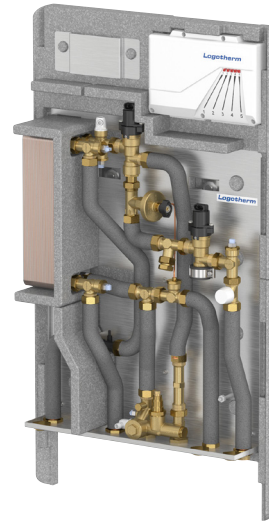
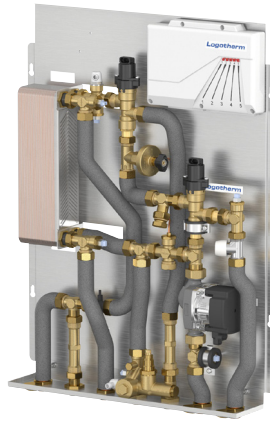

Fig. 4: LogoMatic G2 MC-UC-SI

Fig. 5: LogoMatic G2 MC-UC-DHWC-F/S

Fig. 6: LogoMatic G2 UC-DHWC-SI

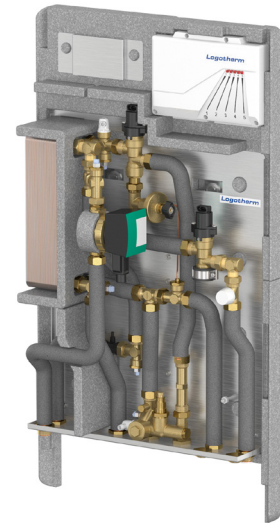
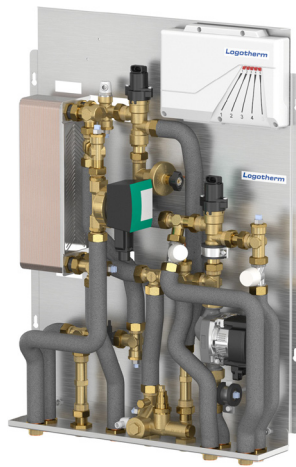
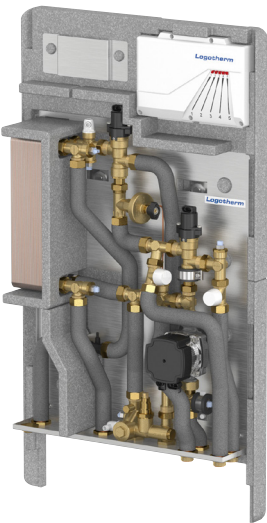
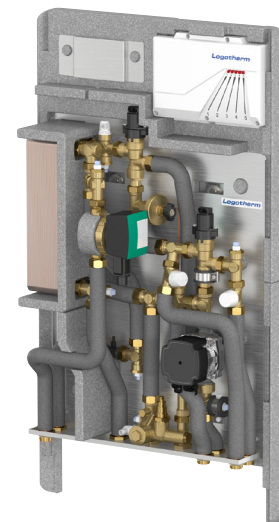

Fig. 7: LogoMatic G2 MC-UC-DHWC-SI

CS = Complete stations, UC = unmixed heating circuit, MC = mixed heating circuit, F or UP = Flush-mounted version, S or AP = wall-mounted version, SI or AP insul. = wall-mounted version for insulated housing, DHWH = domestic hot water circulation; CU = copper-brazed plate heat exchanger, SX = sealed, copper-brazed plate heat exchanger

- ¹ Optionally available with an internal housing insulation.
- ^{2.1} Defined with a flow line temperature of 55°C and heating of 35 K.
- ^{2.2} Defined with a flow line temperature of 65°C and heating of 40 K.
- ^{2.3} Defined with a flow line temperature of 65°C and heating of 35 K.
- ³ All figures are similar to the real model. The kit and scopes of supply may differ. The scope of supply can be found in the product description. All figures are similar.





The Logomatic G2 complete stations permit combination with a wide range of complementary products for further functionalities and equipment for enhanced comfort and easier, optimised integration into building or installation technology. For instance, underfloor manifolds and prewiring concepts can be combined with one another and with the station to save both time and space in installation. Moreover, mounting rails enable a simpler pre-installation and the extensions of the 2nd static heating circuit allow for an easier connection method.

B

Underfloor manifolds

Type	Application		Σ Heating circuits	Type	LogoMatic G2		Order number
	MC	UC			UP / F as well as AP / S	AP insul. / SI	
LogoMatic G2 UFH-M 3MC FS	✓	-	3	F	✓	-	M10515.31
LogoMatic G2 UFH-M 4MC FS	✓	-	4	F	✓	-	M10515.41
LogoMatic G2 UFH-M 5MC FS	✓	-	5	F	✓	-	M10515.51
LogoMatic G2 UFH-M 6MC FS	✓	-	6	F	✓	-	M10515.61
LogoMatic G2 UFH-M 7MC FS	✓	-	7	F	✓	-	M10515.71
LogoMatic G2 UFH-M 8MC FS	✓	-	8	F	✓	-	M10515.81
LogoMatic G2 UFH-M 9MC FS	✓	-	9	E	✓	-	M10515.91
LogoMatic G2 UFH-M 10MC FS	✓	-	10	E	✓	-	M10515.101
LogoMatic G2 UFH-M 11MC FS	✓	-	11	E	✓	-	M10515.111
LogoMatic G2 UFH-M 12MC FS	✓	-	12	E	✓	-	M10515.121
LogoMatic G2 UFH-M 3MC SI	✓	-	3	G	-	✓	M10515.32
LogoMatic G2 UFH-M 4MC SI	✓	-	4	G	-	✓	M10515.42
LogoMatic G2 UFH-M 5MC SI	✓	-	5	G	-	✓	M10515.52
LogoMatic G2 UFH-M 6MC SI	✓	-	6	G	-	✓	M10515.62
LogoMatic G2 UFH-M 7MC SI	✓	-	7	G	-	✓	M10515.72
LogoMatic G2 UFH-M 8MC SI	✓	-	8	G	-	✓	M10515.82

Specifications	Underfloor manifolds		
	Type F	Type E	Type G
Width x height x depth [mm] (dimensions of the housings to be taken into account)	576 x 503 x 140 ¹	792 x 430 x 140 ¹	500 x 452 x 140 ²
Connection to the heating circuits	3/4" M - Euro cone	3/4" M - Euro cone	3/4" M - Euro cone
Arrangement of the supply connections:	top	top	top
Heating circuit manifold material	Stainless steel	Stainless steel	Stainless steel
Control range flow rate limiter [l/min.]	0.5-5	0.5-5	0.5-5
Max. nominal pressure load [bar]	PN6	PN6	PN6
Max. temperature load [°C]	100	100	100
Valve inserts M30 x 1.5 with manual adjustment flaps	✓	✓	✓

¹ The installation depth increases to 160 mm when using pre-wiring packages or increases in general when using and mounting underfloor terminal strips and their mounts.

² These underfloor manifolds are used with wall-mounted stations. The wall-mounted housings supplied by our company require an increased installation depth. Therefore, please take the housing dimensions into account!

Description:

All underfloor manifolds are pre-assembled on a base plate and are fitted with the number of designated heating circuits.

C

Pre-wiring packages

Type	Application		Application Σ		LogoMatic G2		Order number
	MC	UC	heating circuits	Type	UP / F as well as AP / S	AP insul. / SI	
LogoMatic G2 PW concept 8MC FS	✓	-	8	A	✓	-	MB-10560.06
LogoMatic G2 PW concept 12MC FS	✓	-	12	B	✓	-	MB-10560.07
LogoMatic G2 PW concept 8MC SI	✓	-	8	A	-	✓	MB-10560.08
Electro-thermal actuator 230V							M10560.98

Specifications	Pre-wiring package	
	Type A	Type B
For use with up to 8 zones (up to 18 actuators, so that two multiple actuators per zone can be connected)	✓	-
For use with up to 10 zones (up to 18 actuators, so that two multiple actuators per zone can be connected)	-	✓

Description:

Pre-wiring package per interface station with FBH including:

- FBH terminal strip (IP44; supply voltage of actuators 230 V)
- Pump logic module
- Mounting plate for the terminal strip (for access to all assemblies)
- Safety temperature monitor (STW) with thermal actuator
- Professional wiring and supply within the selected station.

Caution: The actuators needed in each case corresponding to the number of floor heating circuits must be ordered separately!



Underfloor manifold (Fig. similar)

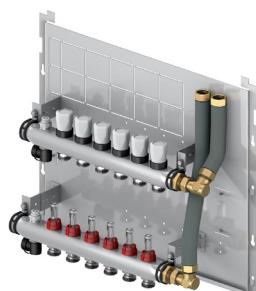

Example underfloor manifold with pre-wiring package (Fig. similar)

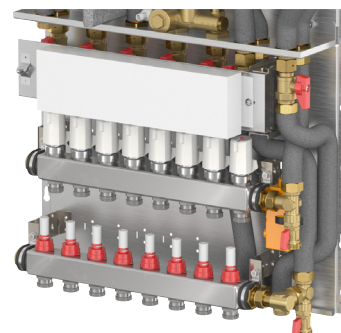

Pre-wiring package (Fig. similar)

D

Second static heating circuit

Type	Application		Application Σ		LogoMatic G2		Order number
	MC	UC	heating circuits	Type	UP / F as well as AP / S	AP insul. / SI	
LogoMatic G2 PW concept 8MC FS	-	✓	1	A	✓	-	M10253.19
LogoMatic G2 PW concept 12MC FS	-	✓	1	B	✓	-	M10253.20
LogoMatic G2 PW concept 8MC SI	-	✓	1	A	-	✓	M10253.21

Specifications	Second static heating circuit	
	Type A	Type B
Application for floor manifolds with up to 8 zones (mixed circuits)	✓	-
Application for floor manifolds with up to 12 zones (mixed circuits)	-	✓

Description:

Second static heating circuit including zone valve.

E

Mounting rails and ball valve sets

Type	Application		Application Σ		LogoMatic G2		Order number
	MC	UC	heating circuits	Type	UP / F as well as AP / S	AP insul. / SI	
LogoMatic G2 FFR 7BV FS	✓	✓	-	A	✓	-	M10203.749
LogoMatic G2 FFR 7BV SI	✓	✓	-	A	-	✓	M10203.762
LogoMatic G2 BV-SET 5BV	✓	✓	-	B	✓	✓	M10252.39
LogoMatic G2 BV-SET 7BV	✓	✓	-	B	✓	✓	M10252.391

Specifications	Second static heating circuit	
	Type A	Type B
Mounting rails for preinstallation including 7 ball valves	✓	-
Ball valve set with 7 ball valves	-	✓

Description:

Including ball valves with DVGW-certified domestic water ball valves (straight model and male thread).

UC = unmixed heating circuit, MC = mixed heating circuit. F or UP = application for flush-mounted version, S or AP = application for wall-mounted version, SI or AP insul. = use for wall-mounted version as insulated housing, UFH-M = underfloor manifold for mixed heating circuits, PW concept = pre-wiring package, UC-L = Extension of 2nd static heating circuit, FFR = mounting rails, BV = ball valve set



F

The LogoMatic G2 complete stations can be combined with various housings as a flush-mounted version (“F” or “UP version) or as a wall-mounted version (“S” or “AP” version and as a designer insulation housing, the “SI” version). This allows us to provide project-specific equipment and to adapt the stations to the room and design concept or the space requirements at the installation site. Moreover, it is also possible to combine the stations with wireless-permeable housings to permit the use of consumption meters such as water and heat meters with wireless communication.



Cladding

Type	Integration underfloor manifolds	max.Σ heating circuits	LogoMatic G2			Fig.	Order number
			UP / F	AP / S	AP insul. / SI		
Flush-mounted cladding 16	-	-	✓	-	-	1	M11100.38
Flush-mounted cladding 17	-	-	✓	-	-		M11100.38K
Flush-mounted cladding 18	✓	≤8	✓	-	-		M11100.39
Flush-mounted cladding 19	✓	< 8	✓	-	-		M11100.39K
Flush-mounted cladding 20	✓	≤12	✓	-	-	2	M11100.42
Flush-mounted cladding 21	✓	≤12	✓	-	-		M11100.42K
LogoMatic G2 Iso pack F	-	-	✓	-	-		M66306.667
Height-adjustable feet 2	-	-	✓	-	-		M11100.21
Height-adjustable feet 3	-	-	✓	-	-		M11100.71
Wall-mounted cladding 16	-	-	-	✓	-	3	M11100.11
Wall-mounted cladding 17	-	-	-	✓	-		M11100.11K
Wall-mounted cladding 18	✓	≤8	-	✓	-		M11100.46
Wall-mounted cladding 19	✓	≤8	-	✓	-	4	M11100.46K
Wall-mounted cladding 20	✓	≤12	-	✓	-	5	M11100.43
Wall-mounted cladding 21	✓	≤12	-	✓	-		M11100.43K
LogoMatic G2 Iso case short SI	-	-	-	-	✓	6	M66306.665
LogoMatic G2 Iso case long SI	✓	≤8	-	-	✓		M66306.666

F or UP = application for flush-mounted version, S or AP = application for wall-mounted version, SI or AP insul. = application for wall-mounted version as insulated housing

All figures are similar to the real model. The kit and scopes of supply may differ.

The scope of supply can be found in the product description.



Fig. 1



Fig. 2



Fig. 3



Fig. 4



Fig. 5

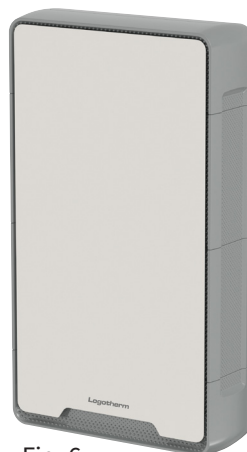

Fig. 6



F

Cladding

Type	with door	long ¹⁾	Wireless ²⁾	Width [mm]	Height [mm]	Depth [mm]	Order number
Flush-mounted cladding 16	-	-	-	610 ³⁾ (655) ⁴⁾	935 ³⁾ (953) ⁴⁾	110-160 ⁵⁾	M11100.38
Flush-mounted cladding 17	-	-	✓	610 ³⁾ (655) ⁴⁾	935 ³⁾ (953) ⁴⁾	110-160 ⁵⁾	M11100.38K
Flush-mounted cladding 18	-	✓	-	610 ³⁾ (655) ⁴⁾	1300 ³⁾ (1327) ⁴⁾	110-160 ⁵⁾	M11100.39
Flush-mounted cladding 19	-	✓	✓	610 ³⁾ (655) ⁴⁾	1300 ³⁾ (1327) ⁴⁾	110-160 ⁵⁾	M11100.39K
Flush-mounted cladding 20	-	✓	-	847 ³⁾ (890) ⁴⁾	1300 ³⁾ (1327) ⁴⁾	150-245 ⁵⁾	M11100.42
Flush-mounted cladding 21	-	✓	✓	847 ³⁾ (890) ⁴⁾	1300 ³⁾ (1327) ⁴⁾	150-245 ⁵⁾	M11100.42K
LogoMatic G2 Iso pack F ⁷⁾	-	-	-	-	-	-	M66306.667
Height-adjustable feet 2 ⁸⁾	-	-	-	610	-	-	M11100.21
Height-adjustable feet 3 ⁸⁾	-	-	-	825	-	-	M11100.71
Wall-mounted cladding 16	-	-	-	600	935	210	M11100.11
Wall-mounted cladding 17	-	-	✓	600	935	210	M11100.11K
Wall-mounted cladding 18	-	✓	-	600	1330	210	M11100.46
Wall-mounted cladding 19	-	✓	✓	600	1330	210	M11100.46K
Wall-mounted cladding 20	-	✓	-	850	1330	210	M11100.43
Wall-mounted cladding 21	-	✓	✓	850	1330	210	M11100.43K
LogoMatic G2 Iso case short SI ⁶⁾	-	-	✓	600	1050	220	M66306.665
LogoMatic G2 Iso case long SI ⁶⁾	-	✓	✓	600	1375	220	M66306.666

¹⁾ Height >1,100mm

²⁾ Housing with the option of wireless consumption metering readout thanks to the plastic insert or designer insulation housing

³⁾ With flush-mounted versions, this gives the cut-out dimensions required to embed the station in the wall (dimensions A1 and A2)

⁴⁾ With flush-mounted versions, this gives the dimensions of the panel which is visible from the outside (dimensions B1 and B2)

⁵⁾ With flush-mounted versions, the depth is freely adjustable in accordance with the information

⁶⁾ The designer insulation housings listed (LogoMatic G2 Iso case) are available as wall-mounted versions and guarantee highly efficient operation thanks to their 30 mm wall thickness. All our designer insulation housings come with a white designer front panel and are thus attractive to look at

⁷⁾ For the existing flush-mounted versions, you can opt for internal insulation in the housing (LogoMatic G2 Iso pack F) for increased efficiency and the associated protection from heat radiation, which is preinstalled and fully set up in the housing at the point of ordering

⁸⁾ For the existing flush-mounted versions there are height-adjustable feet with a setting range of 100 to 170 mm. You are welcome to enquire about alternative versions for other setting ranges.

The cladding types (painted steel housing) listed are available as wall-mounted or flush-mounted variants, and may also be used for wireless meter reading applications when using consumption metering with wireless transmission. Cladding: steel painted white (RAL 9016) and plastic panel in white (RAL 9016) for wireless applications.



Example representation of the dimensions for UP cladding

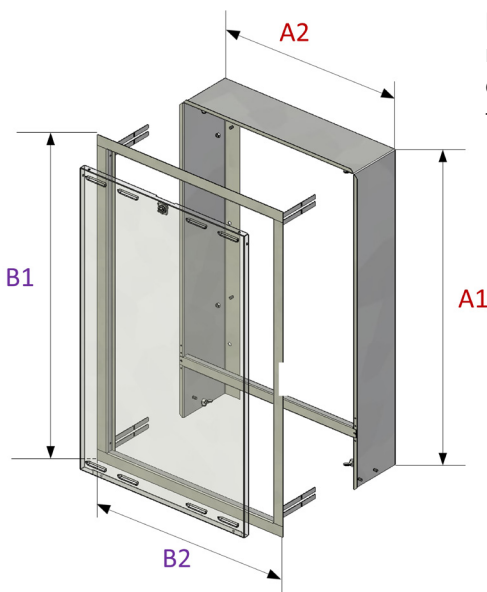

Example representation of the dimensions for AP cladding

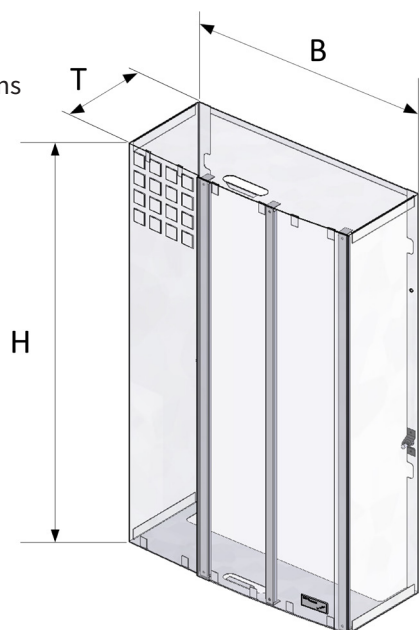

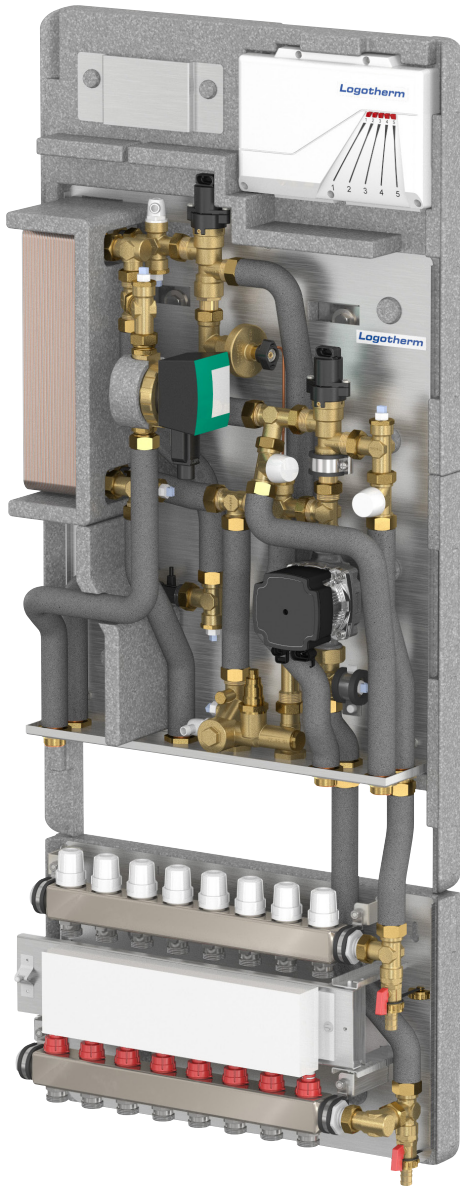

LogoMatic G2 L-Line MC-UC CU SI

Included complementary products:

- Design insulated housing (type: LogoMatic G2 Iso case long SI)
- 8-way underfloor manifold (type: LogoMatic G2 UFH-M 8MC SI)
- Pre-wiring package (type: LogoMatic G2 PW concept 8MC SI)

LogoMatic G2 L-Line MC-UC DHWC CU SI

Included complementary products:

- Ball valve connection set (type: LogoMatic G2 BV-SET 5BV)
- Design insulated housing (type: LogoMatic G2 Iso case long SI)
- 8-way underfloor manifold (type: LogoMatic G2 UFH-M 8MC SI)
- Pre-wiring package (type: LogoMatic G2 PW concept 8MC SI)
- Actuators
- Consumption metering (water & heat flow meter)

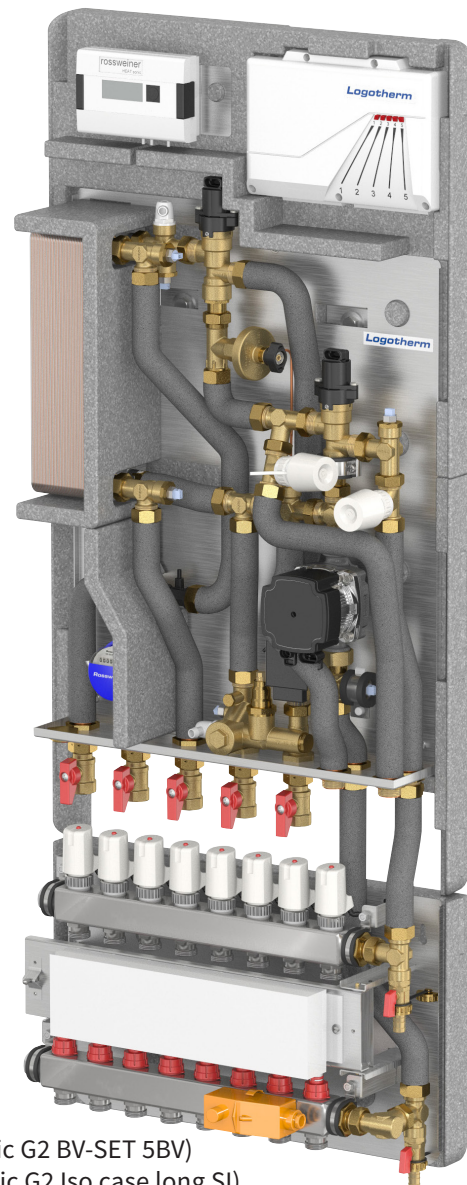

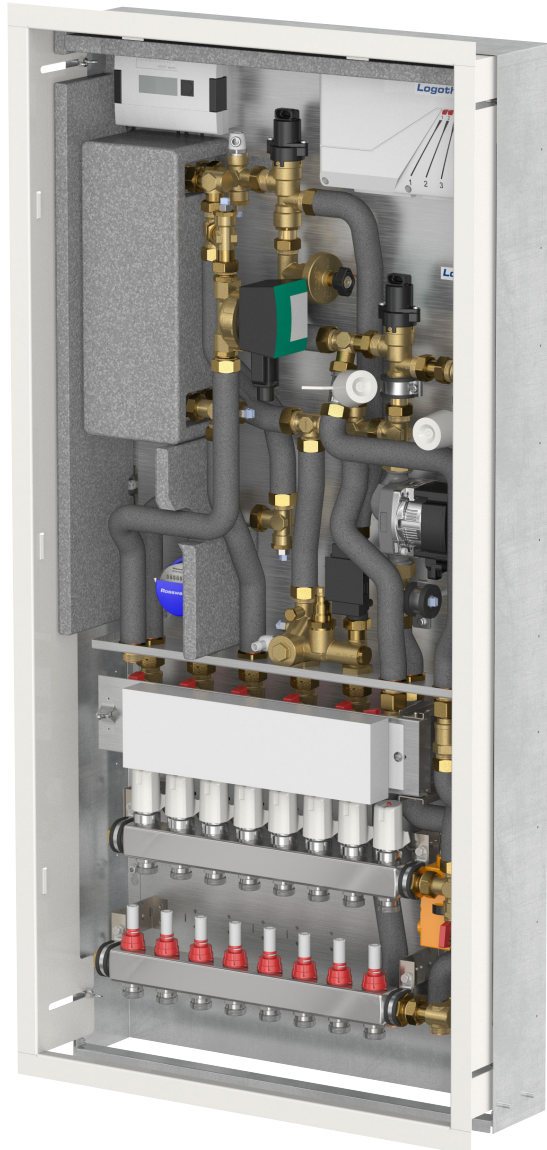

LogoMatic G2 L-Line MC-UC DHWC CU F

Included complementary products:

- Ball valve connection set (type: LogoMatic G2 BV-SET 7BV)
- Flush-mounted housing
- Internal housing insulation (type: LogoMatic G2 Iso pack F)
- 8-way underfloor manifold (type: LogoMatic G2 UFH-M 8MC FS)
- Pre-wiring package (type: LogoMatic G2 PW concept 8MC FS)
- Actuators
- Consumption metering (water & heat flow meter)

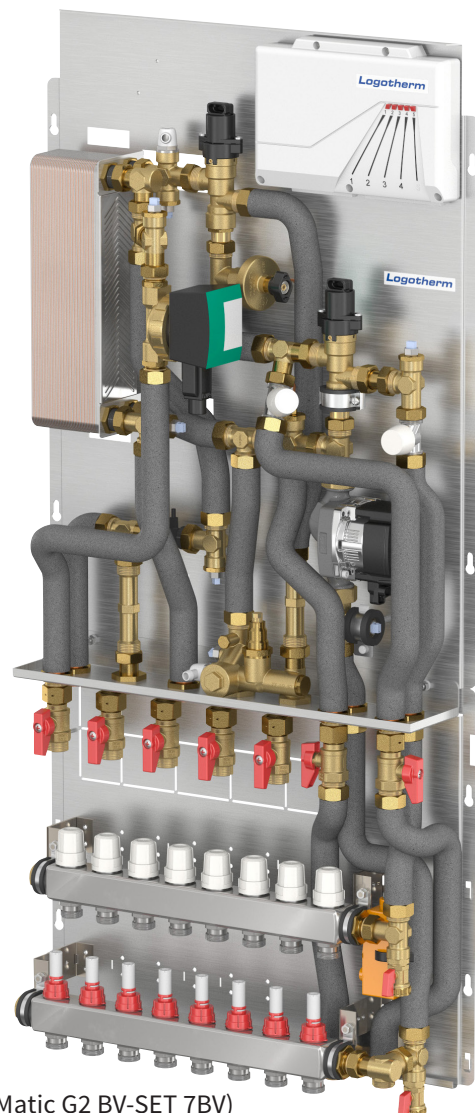

LogoMatic G2 L-Line MC-UC DHWC CU F

Included complementary products:

- Ball valve connection set (type: LogoMatic G2 BV-SET 7BV)
- 8-way underfloor manifold (type: LogoMatic G2 UFH-M 8MC FS)
- Extension of 2nd static heating circuit (type: LogoMatic G2 UC-L 8MC FS)



LogoMatic G2 S-Line

Performance table and diagrams for hot water preparation

Hot water preparation from 10°C to 45°C (35 Kelvin)

Primary flow temperature for heating [°C]	47	50	55	60	65	70	75	80	85
Hot water output [l/min]	5.8	8.7	12.0	12.0	12.0	12.0	12.0	12.0	12.0
Hot water output [kW]	14.1	21.3	29.3	29.3	29.3	29.3	29.3	29.3	29.3
Primary volume flow for heating [l/min]	17.8	17.8	16.7	12.4	10.1	8.7	7.6	6.8	6.2
Primary return line temperature [°C]	36	22	30	26	24	22	20	19	17
Primary pressure loss [kPa]	50	50	44	24	16	12	9	7	6
Pressure loss for domestic water [kPa]	21	54	100	100	100	100	100	100	100
Calculated mixed water at 38 °C ¹⁾ [l/min]	7.2	10.9	15.0	15.0	15.0	15.0	15.0	15.0	15.0

¹⁾ The calculated mixed water volume is an indication of the maximum achievable water volume at 38°C (draw-off at the individual draw-off points and not at the station).

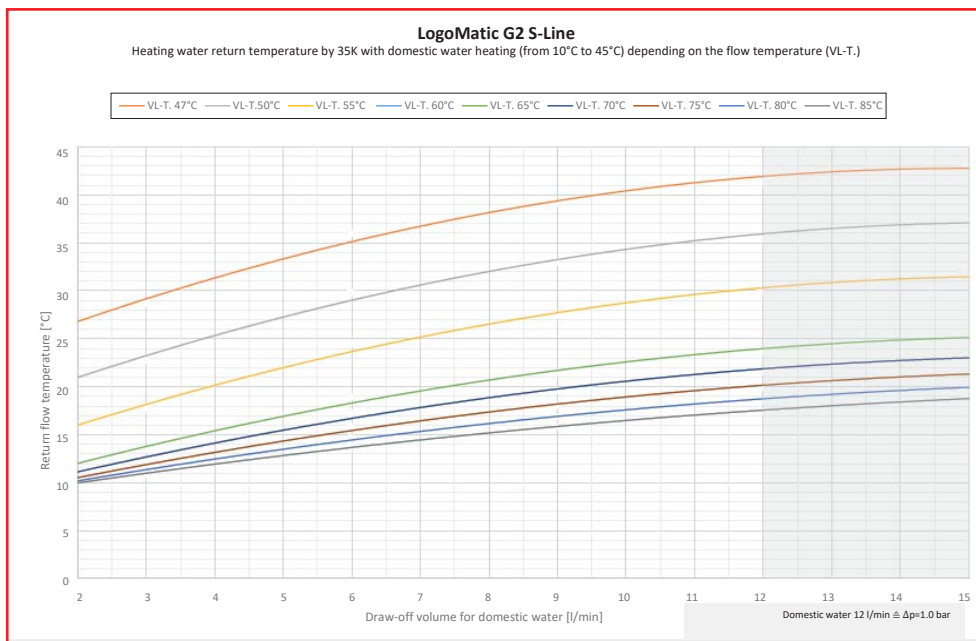
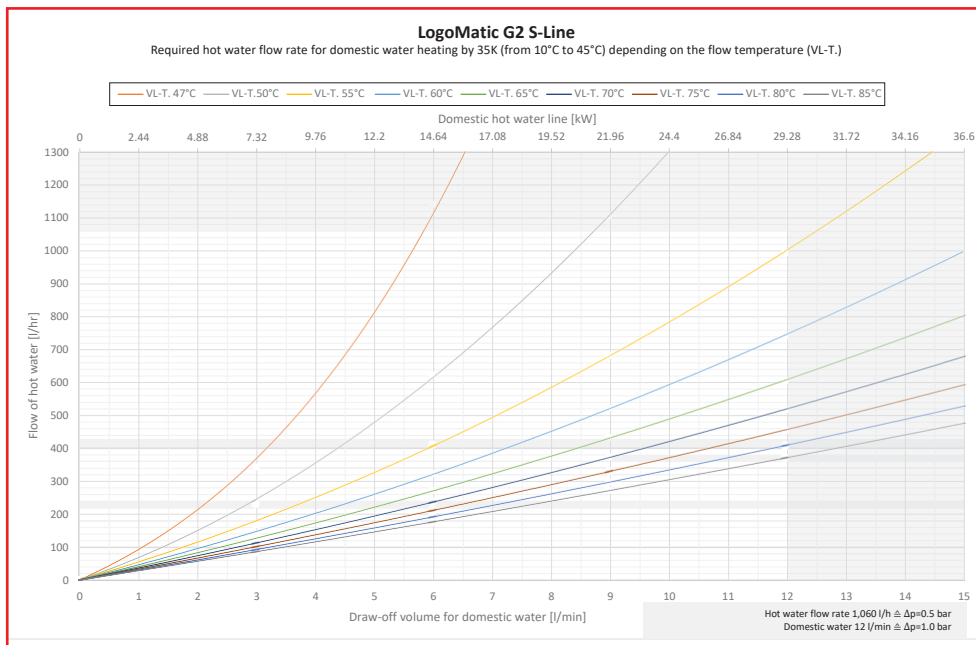



Hot water preparation from 10°C to 50°C (40 Kelvin)

Primary flow temperature for heating [°C]		52	55	60	65	70	75	80	85
Hot water output [l/min]	-	5.6	8.4	11.9	12.0	12.0	12.0	12.0	12.0
Hot water output [kW]	-	15.6	23.4	33.2	33.4	33.4	33.4	33.4	33.4
Primary volume flow for heating [l/min]	-	17.8	17.8	17.8	13.4	11.0	9.4	8.3	7.4
Primary return line temperature [°C]	-	39	36	33	29	26	24	22	21
Primary pressure loss [kPa]	-	50	50	50	29	19	14	11	9
Pressure loss for domestic water [kPa]	-	20	49	100	100	100	100	100	100
Calculated mixed water at 38 °C ¹⁾ [l/min]	-	8.0	12.0	17.0	17.1	17.1	17.1	17.1	17.1

¹⁾The calculated mixed water volume is an indication of the maximum achievable water volume at 38°C (draw-off at the individual draw-off points and not at the station).

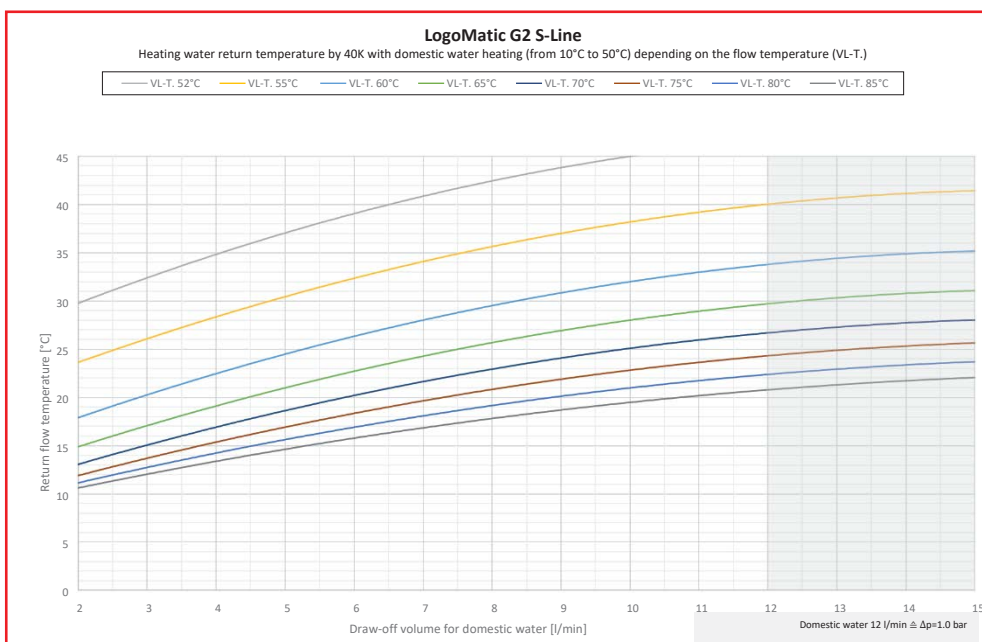
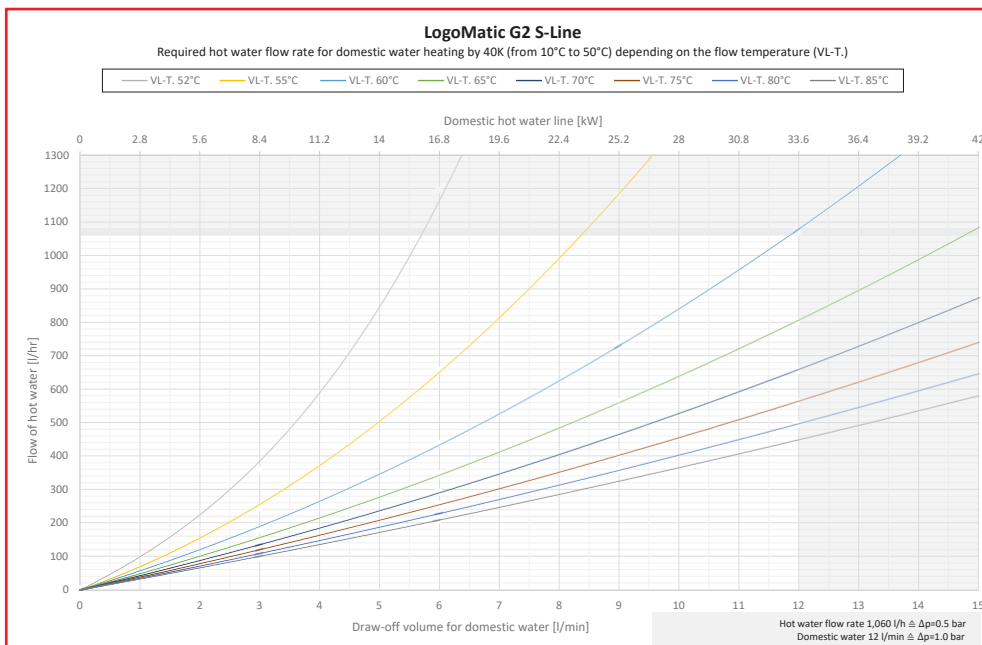



Hot water preparation from 10°C to 55°C (45 Kelvin)

Primary flow temperature for heating [°C]			57	60	65	70	75	80	85
Hot water output [l/min]	-	-	5.5	8.1	11.4	12.0	12.0	12.0	12.0
Hot water output [kW]	-	-	17.1	25.4	35.7	37.6	37.6	37.6	37.6
Primary volume flow for heating [l/min]	-	-	17.8	17.8	17.8	14.3	11.7	10.1	8.9
Primary return line temperature [°C]	-	-	43	39	36	32	29	26	24
Primary pressure loss [kPa]	-	-	50	50	50	32	22	16	13
Pressure loss for domestic water [kPa]	-	-	19	46	96	100	100	100	100
Calculated mixed water at 38 °C ¹⁾ [l/min]	-	-	8.8	13.0	18.3	19.3	19.3	19.3	19.3

¹⁾ The calculated mixed water volume is an indication of the maximum achievable water volume at 38°C (raw-off at the individual draw-off points and not at the station).

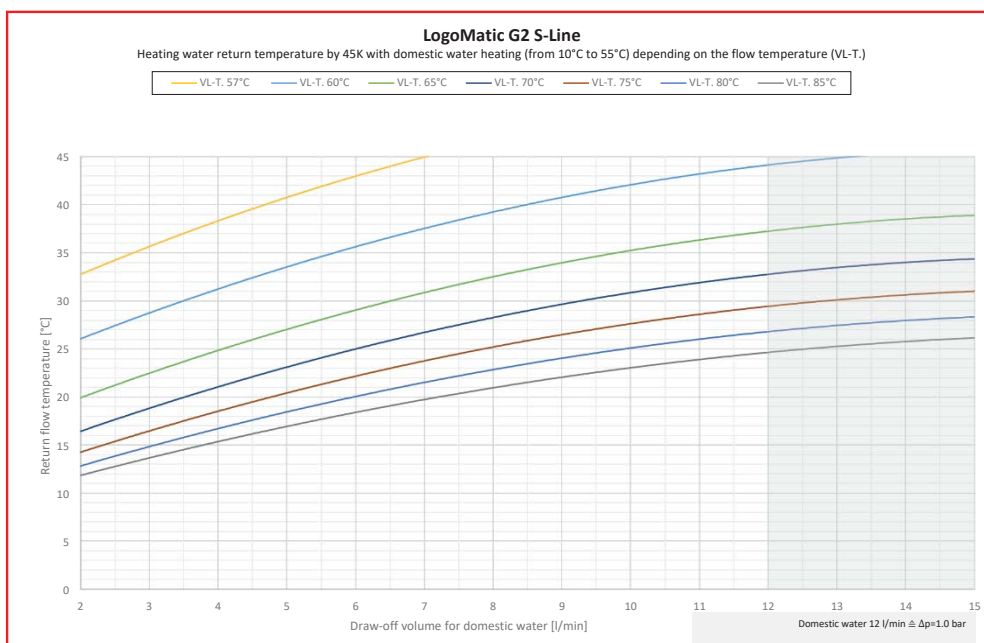
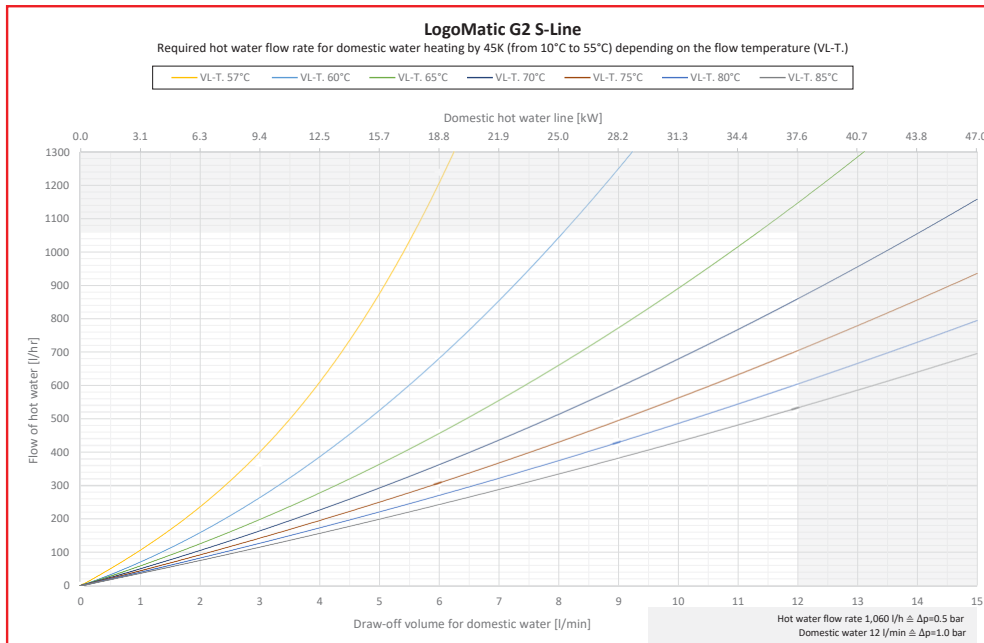



Hot water preparation from 10°C to 60°C (50 Kelvin)

Primary flow temperature for heating [°C]				62	65	70	75	80	85
Hot water output [l/min]	-	-	-	5.4	7.9	11.0	12.0	12.0	12.0
Hot water output [kW]	-	-	-	18.8	27.5	38.3	41.8	41.8	41.8
Primary volume flow for heating [l/min]	-	-	-	17.8	17.8	17.8	15.1	12.4	10.7
Primary return line temperature [°C]	-	-	-	47	43	39	35	32	29
Primary pressure loss [kPa]	-	-	-	50	50	50	36	24	18
Pressure loss for domestic water [kPa]	-	-	-	18	43	88	100	100	100
Calculated mixed water at 38 °C ¹⁾ [l/min]	-	-	-	9.6	14.1	19.6	21.4	21.4	21.4

¹⁾ The calculated mixed water volume is an indication of the maximum achievable water flow at 38°C (draw-off at the individual draw-off points and not at the station).

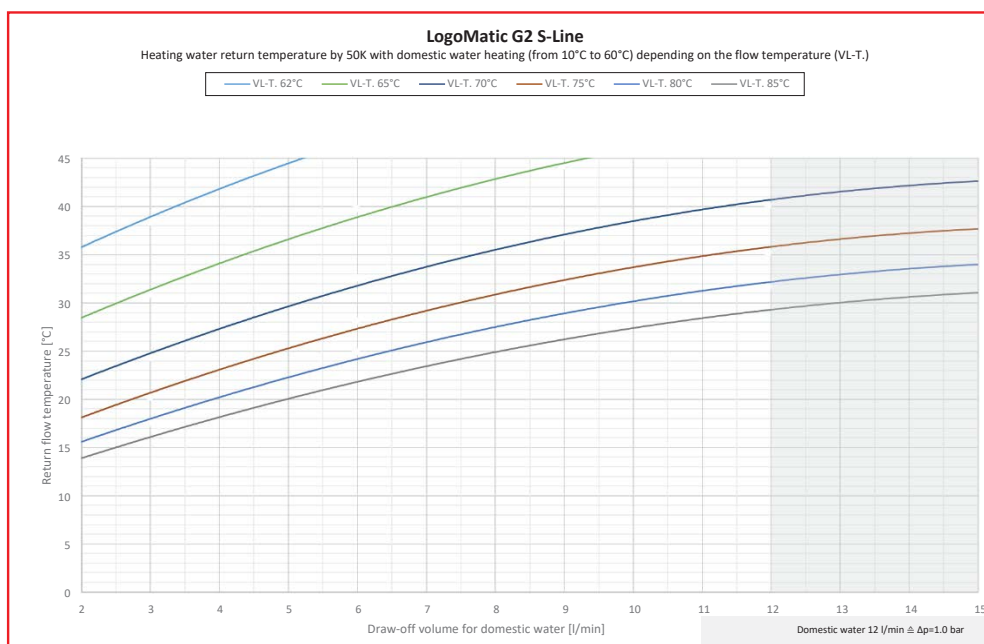
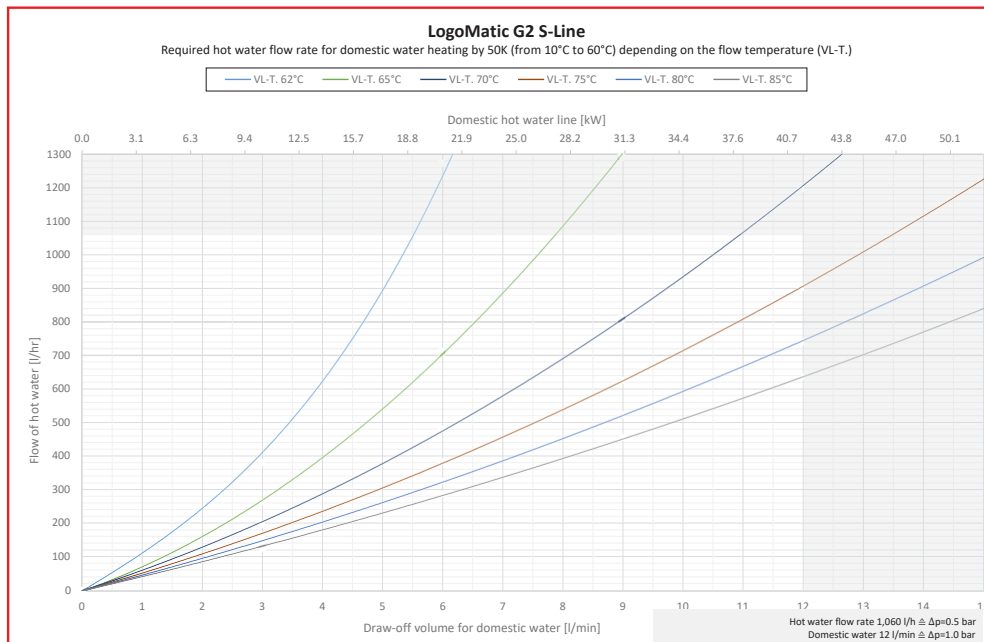



LogoMatic G2 M-Line Performance table and diagrams for hot water preparation

Hot water preparation from 10°C to 45°C (35 Kelvin)

Primary flow temperature for heating [°C]	47	50	55	60	65	70	75	80	85
Hot water output [l/min]	8.8	12.1	16.1	17.0	17.0	17.0	17.0	17.0	17.0
Hot water output [kW]	21.5	29.5	39.3	41.4	41.4	41.4	41.4	41.4	41.4
Primary volume flow for heating [l/min]	18.4	18.4	18.4	15.5	13.0	11.4	10.1	9.2	8.4
Primary return line temperature [°C]	30	27	24	22	19	18	16	15	14
Primary pressure loss [kPa]	50	50	50	36	26	20	17	14	12
Pressure loss for domestic water [kPa]	24	43	86	100	100	100	100	100	100
Calculated mixed water at 38 °C ¹⁾ [l/min]	11.0	15.1	20.2	21.3	21.3	21.3	21.3	21.3	21.3

¹⁾ The calculated mixed water volume is an indication of the maximum achievable water volume at 38°C (draw-off at the individual draw-off points and not at the station).

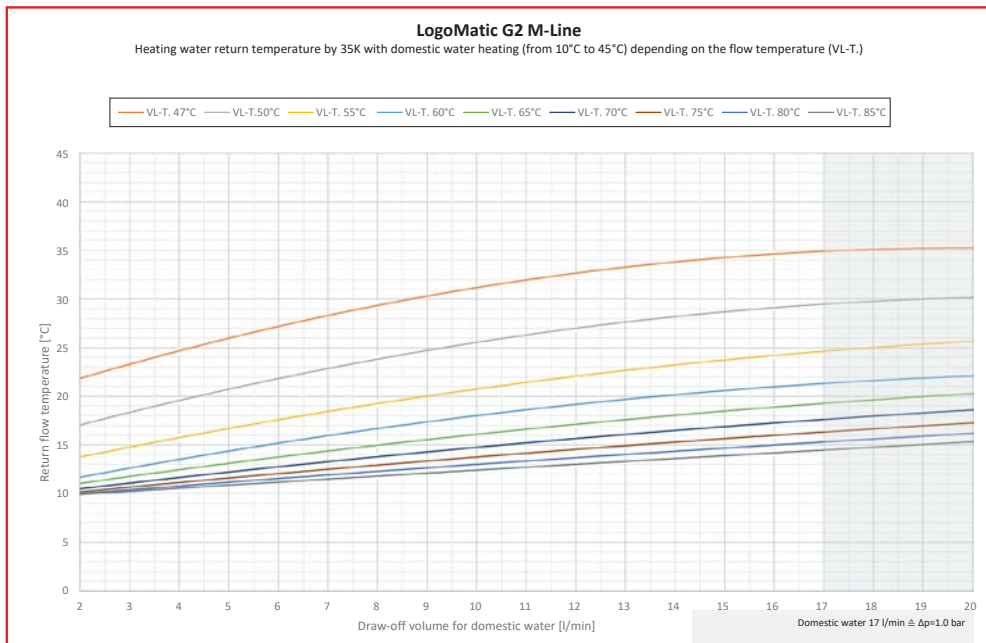
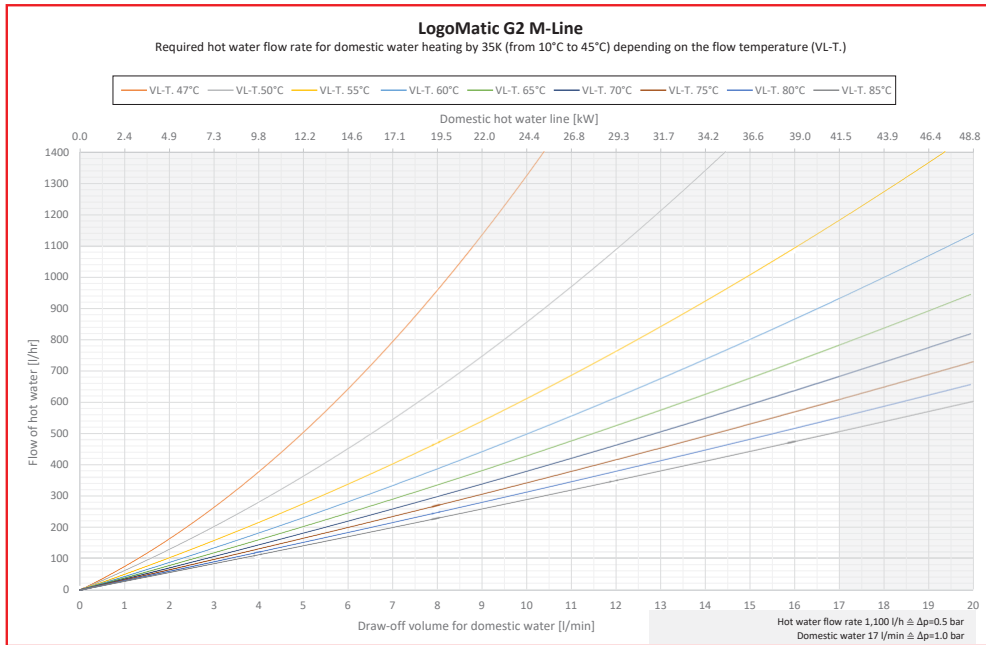



Hot water preparation from 10°C to 50°C (40 Kelvin)

Primary flow temperature for heating [°C]		52	55	60	65	70	75	80	85
Hot water output [l/min]	-	8.6	11.6	15.4	17.0	17.0	17.0	17.0	17.0
Hot water output [kW]	-	23.9	32.4	42.8	47.4	47.4	47.4	47.4	47.4
Primary volume flow for heating [l/min]	-	18.4	18.4	18.4	16.6	14.0	12.2	11.0	10.0
Primary return line temperature [°C]	-	33	30	27	24	21	19	18	17
Primary pressure loss [kPa]	-	50	50	50	41	30	23	19	16
Pressure loss for domestic water [kPa]	-	23	40	76	100	100	100	100	100
Calculated mixed water at 38°C ¹⁾ [l/min]	-	12.3	16.6	22.0	24.3	24.3	24.3	24.3	24.3

¹⁾ The calculated mixed water volume is an indication of the maximum achievable water volume at 38°C (draw-off at the individual draw-off points and not at the station).

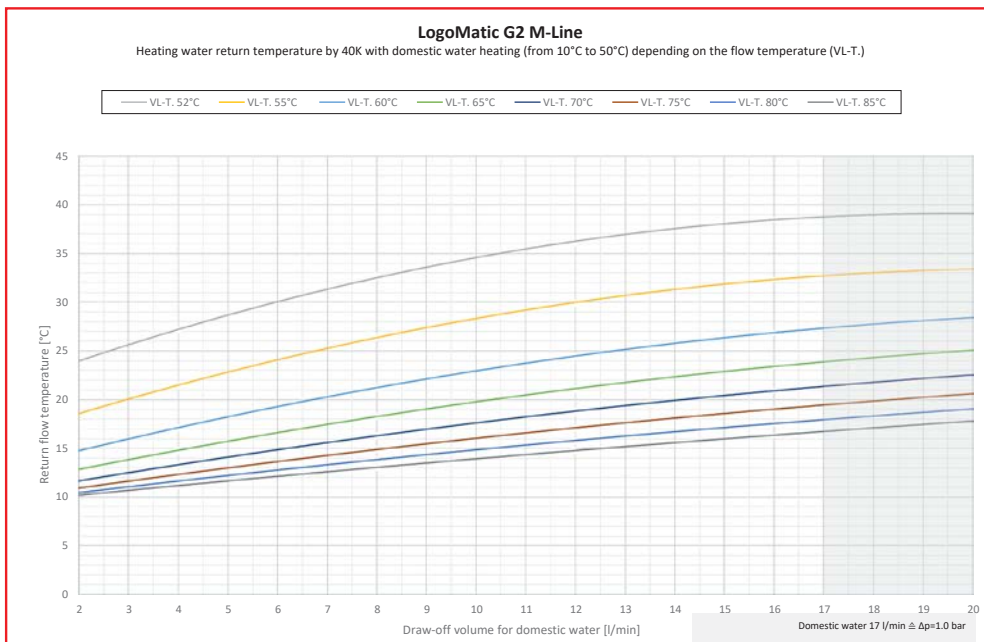
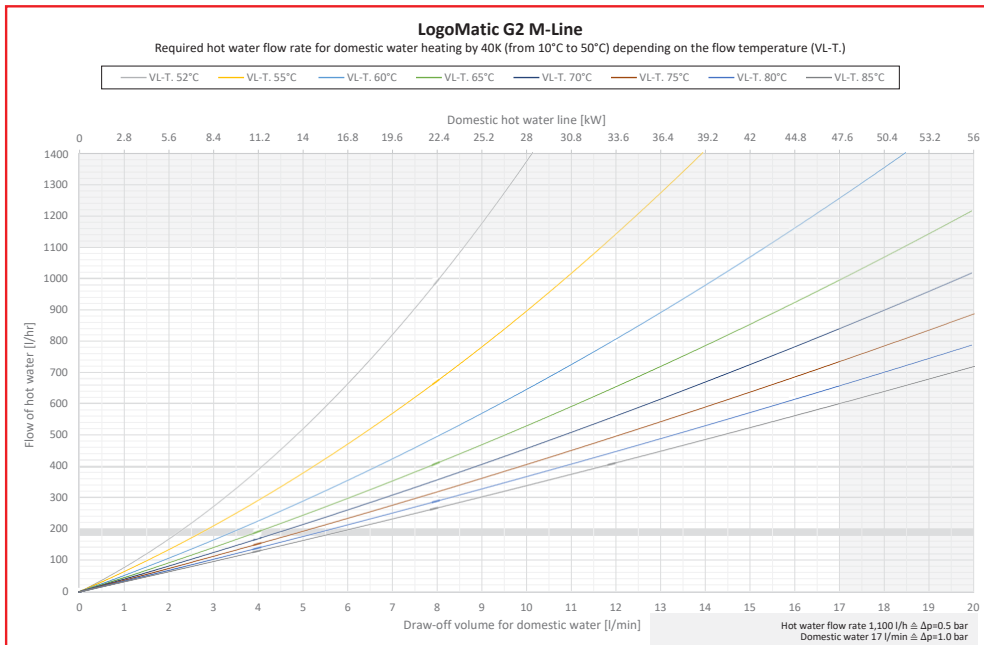



Hot water preparation from 10°C to 55°C (45 Kelvin)

Primary flow temperature for heating [°C]			57	60	65	70	75	80	85
Hot water output [l/min]	-	-	8.4	11.3	14.8	17.0	17.0	17.0	17.0
Hot water output [kW]	-	-	26.4	35.5	46.3	53.3	53.3	53.3	53.3
Primary volume flow for heating [l/min]	-	-	18.4	18.4	18.4	17.5	14.9	13.0	11.7
Primary return line temperature [°C]	-	-	36	32	29	26	24	21	20
Primary pressure loss [kPa]	-	-	50	50	50	46	33	26	21
Pressure loss for domestic water [kPa]	-	-	22	38	69	100	100	100	100
Calculated mixed water at 38 °C ¹⁾ [l/min]	-	-	13.6	18.2	23.8	27.3	27.3	27.3	27.3

¹⁾ The calculated mixed water volume is an indication of the maximum achievable water volume at 38°C (draw-off at the individual draw-off points and not at the station).

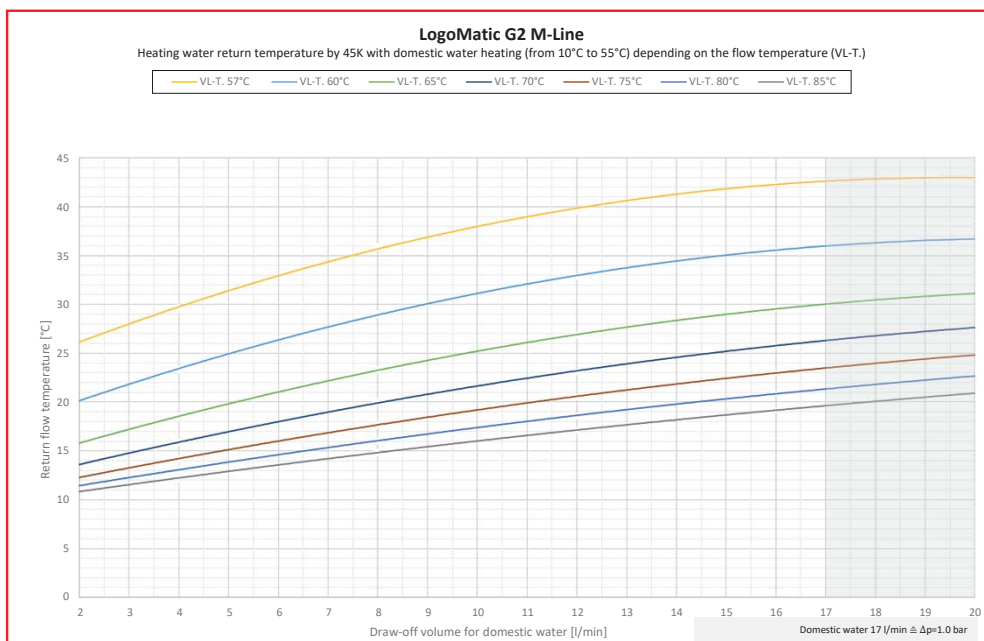
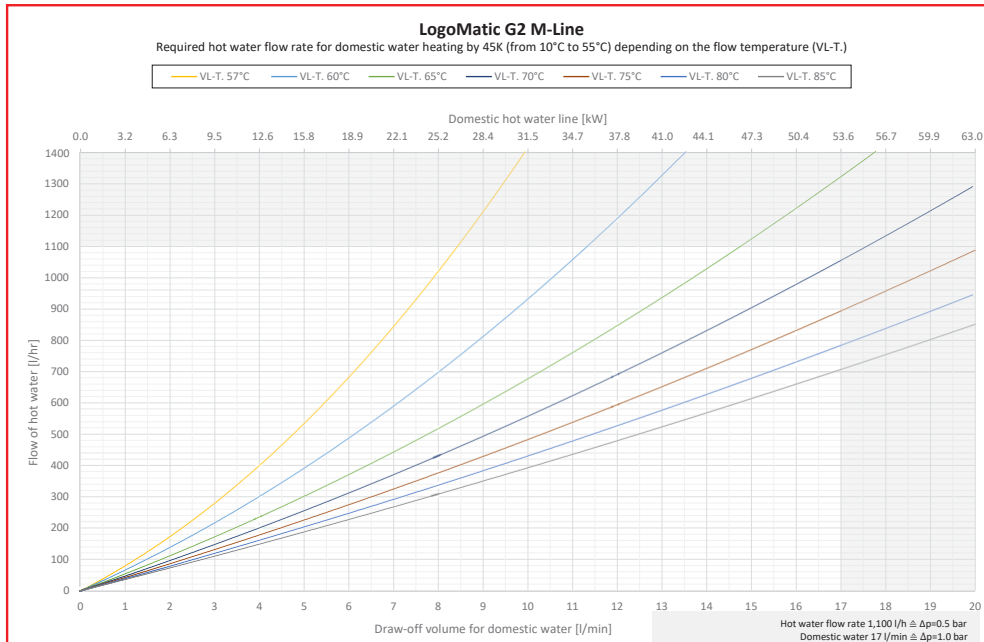



Hot water preparation from 10°C to 60°C (50 Kelvin)

Primary flow temperature for heating [°C]				62	65	70	75	80	85
Hot water output [l/min]	-	-	-	8.3	11.1	14.3	17.0	17.0	17.0
Hot water output [kW]	-	-	-	28.9	38.5	49.8	59.3	59.2	59.2
Primary volume flow for heating [l/min]	-	-	-	18.4	18.4	18.4	18.4	15.6	13.8
Primary return line temperature [°C]	-	-	-	39	35	31	29	26	23
Primary pressure loss [kPa]	-	-	-	50	50	50	50	37	29
Pressure loss for domestic water [kPa]	-	-	-	22	36	64	100	100	100
Calculated mixed water at 38 °C ¹⁾ [l/min]	-	-	-	14.8	19.7	25.6	30.4	30.4	30.4

¹⁾ The calculated mixed water volume is an indication of the maximum achievable water volume at 38°C (draw-off at the individual draw-off points and not at the station).

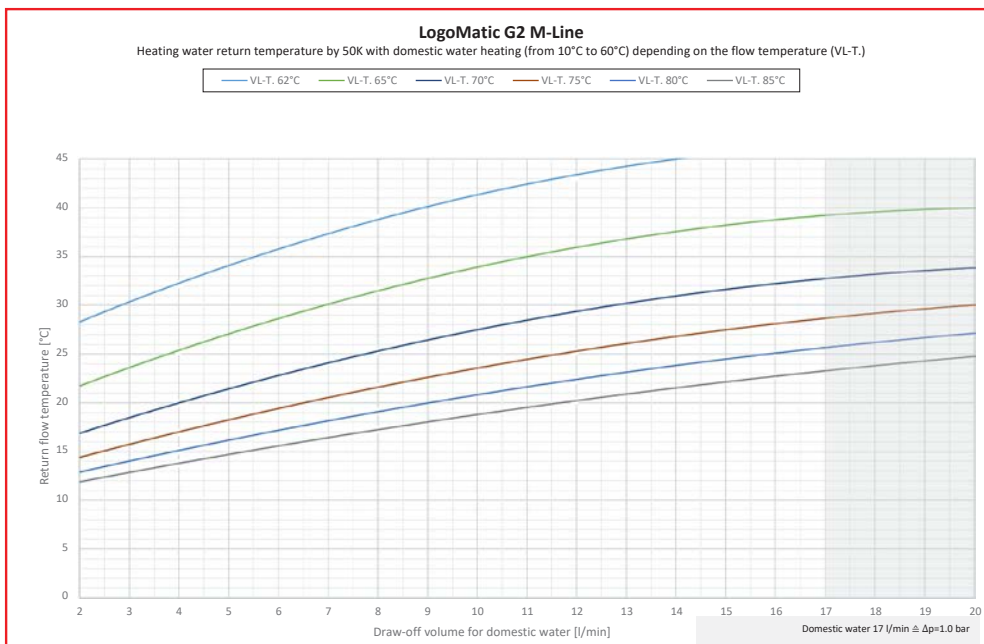
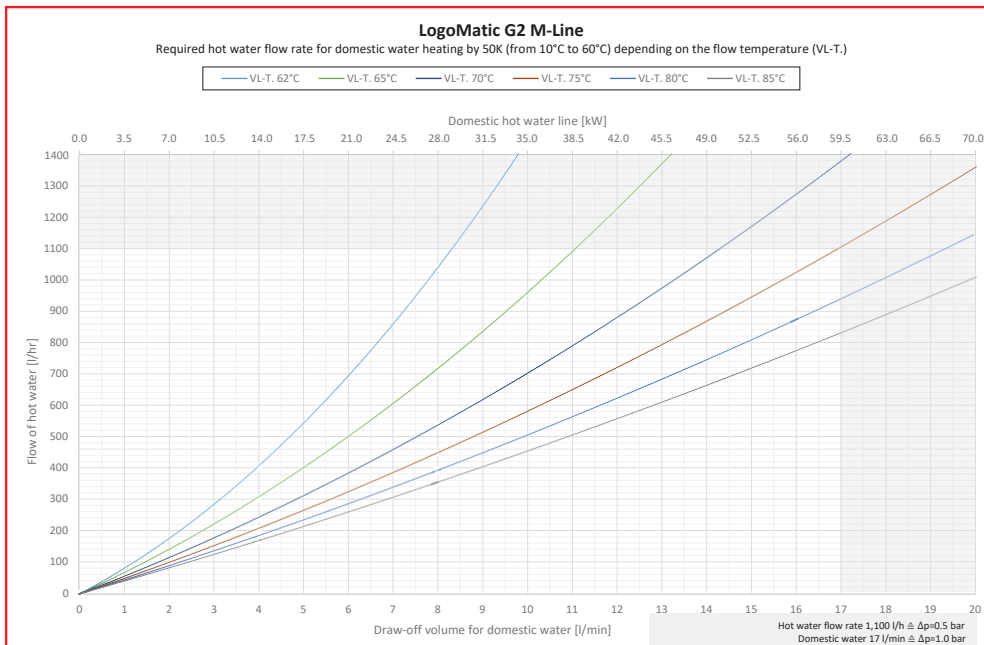



LogoMatic G2 L-Line

Performance table and diagrams for hot water preparation

Hot water preparation from 10°C to 45°C (35 Kelvin)

Primary flow temperature for heating [°C]	47	50	55	60	65	70	75	80	85
Hot water output [l/min]	14.4	18.3	22.0	22.0	22.0	22.0	22.0	22.0	22.0
Hot water output [kW]	35.1	44.7	53.6	53.6	53.6	53.6	53.6	53.6	53.6
Primary volume flow for heating [l/min]	21.2	21.2	20.1	22.0	14.9	13.4	12.2	11.2	10.4
Primary return line temperature [°C]	23	20	17	15	13	12	12	11	11
Primary pressure loss [kPa]	70	70	63	45	34	28	23	19	17
Pressure loss for domestic water [kPa]	45	72	100	100	100	100	100	100	100
Calculated mixed water at 38 °C ¹⁾ [l/min]	18.0	22.9	27.5	27.5	27.5	27.5	27.5	27.5	27.5

¹⁾ The calculated mixed water volume is an indication of the maximum achievable water volume at 38°C (draw-off at the individual draw-off points and not at the station).

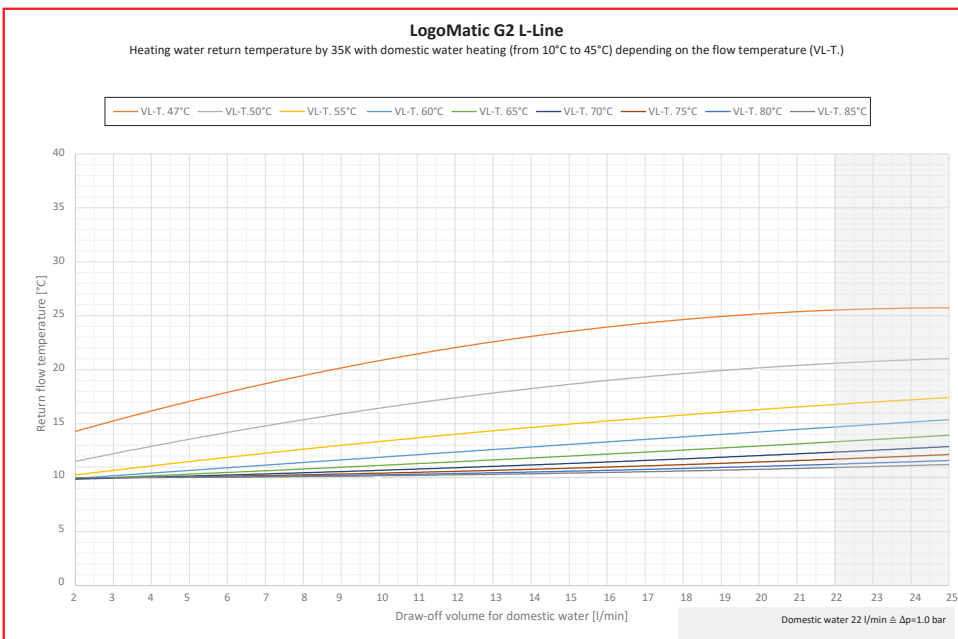
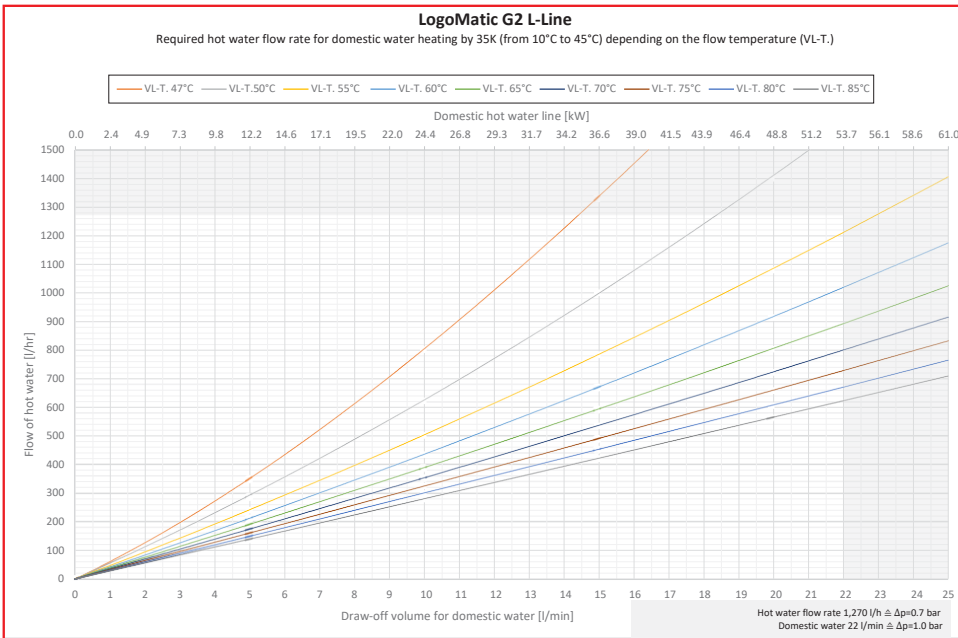



Hot water preparation from 10°C to 50°C (40 Kelvin)

Primary flow temperature for heating [°C]		52	55	60	65	70	75	80	85
Hot water output [l/min]	-	14.1	17.8	22.0	22.0	22.0	22.0	22.0	22.0
Hot water output [kW]	-	39.3	49.6	61.3	61.3	61.3	61.3	61.3	61.3
Primary volume flow for heating [l/min]	-	21.2	21.2	21.0	17.9	15.8	14.2	13.0	12.0
Primary return line temperature [°C]	-	25	21	18	16	14	13	12	12
Primary pressure loss [kPa]	-	70	70	69	50	39	31	26	22
Pressure loss for domestic water [kPa]	-	43	67	100	100	100	100	100	100
Calculated mixed water at 38 °C ¹⁾ [l/min]	-	20.2	25.4	31.4	31.4	31.4	31.4	31.4	31.4

¹⁾ The calculated mixed water volume is an indication of the maximum achievable water volume at 38°C (draw-off at the individual draw-off points and not at the station).

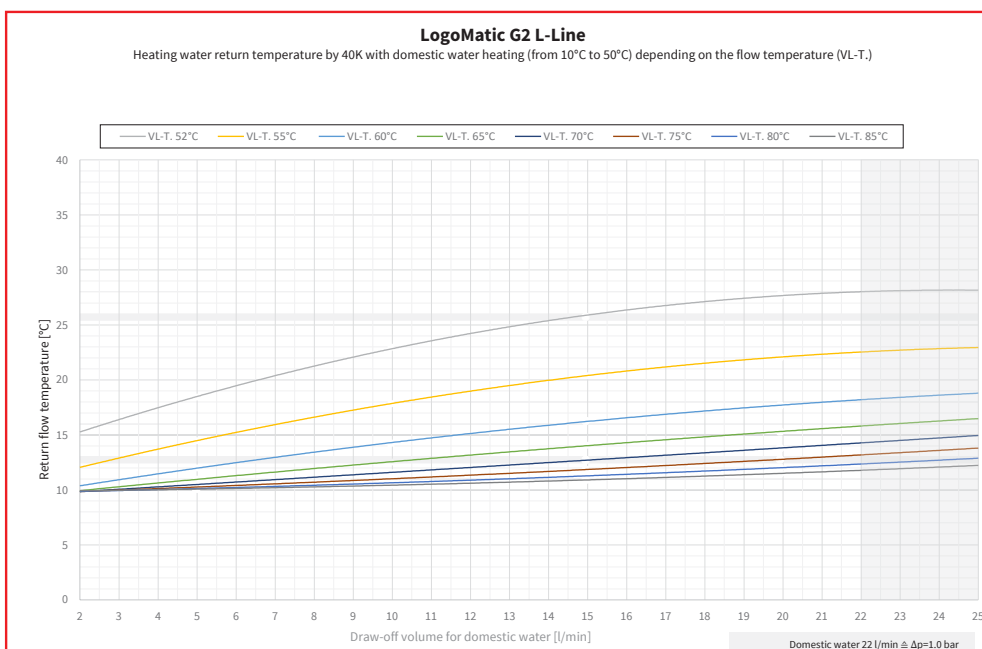
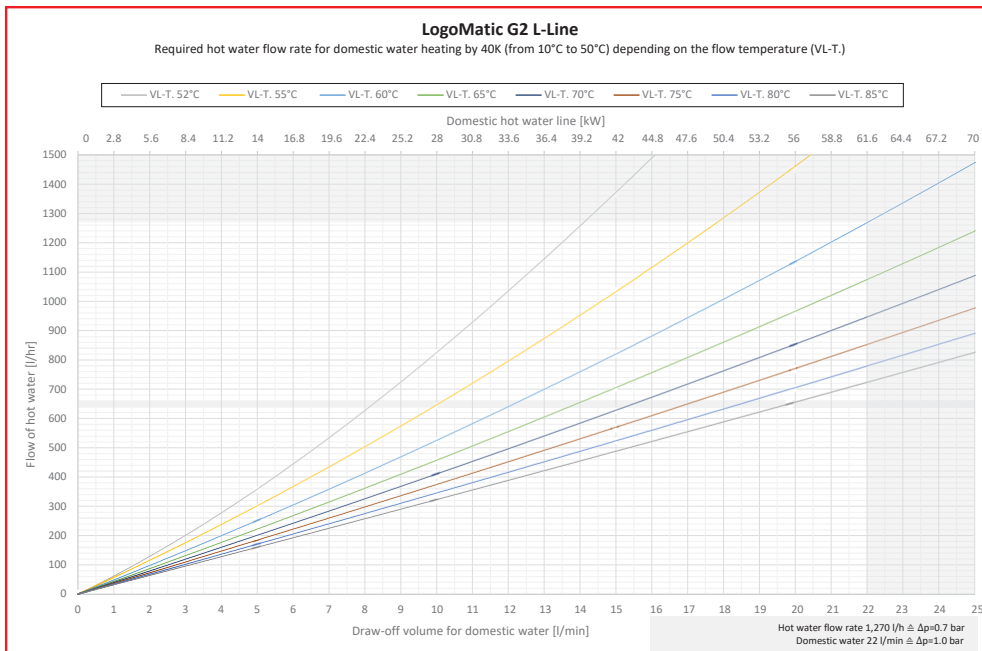



Hot water preparation from 10°C to 55°C (45 Kelvin)

Primary flow temperature for heating [°C]			57	60	65	70	75	80	85
Hot water output [l/min]	-	-	13.9	17.4	21.4	22.0	22.0	22.0	22.0
Hot water output [kW]	-	-	43.6	54.4	67.1	68.9	68.9	68.9	68.9
Primary volume flow for heating [l/min]	-	-	21.2	21.2	21.2	18.6	16.5	15.0	13.7
Primary return line temperature [°C]	-	-	27	23	20	17	15	14	13
Primary pressure loss [kPa]	-	-	70	70	70	54	42	35	29
Pressure loss for domestic water [kPa]	-	-	41	64	97	100	100	100	100
Calculated mixed water at 38°C ¹⁾ [l/min]	-	-	22.3	27.9	34.4	35.4	35.4	35.4	35.4

¹⁾ The calculated mixed water volume is an indication of the maximum achievable water volume at 38°C (draw-off at the individual draw-off points and not at the station).

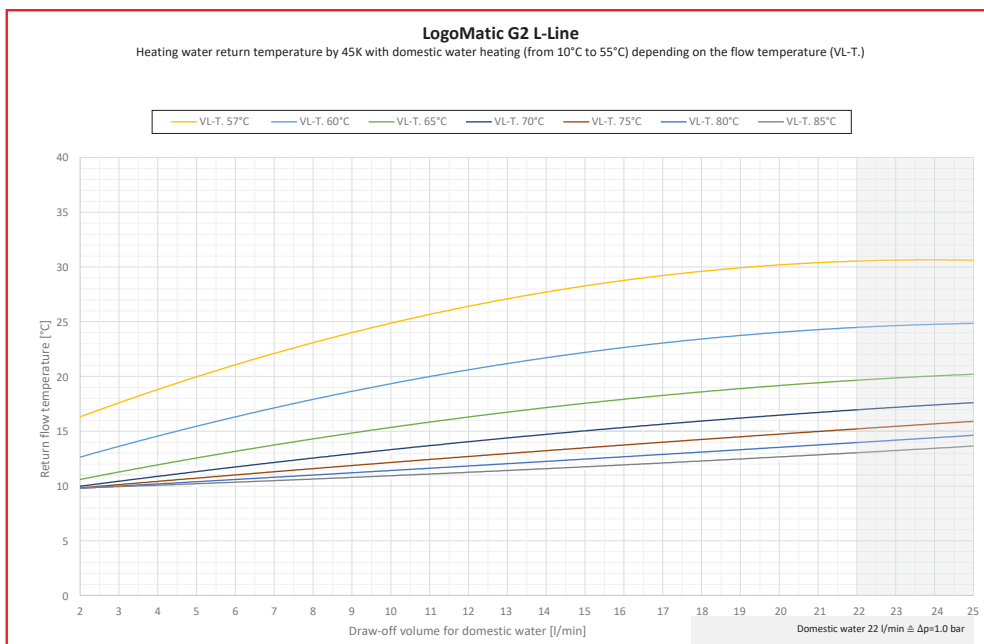
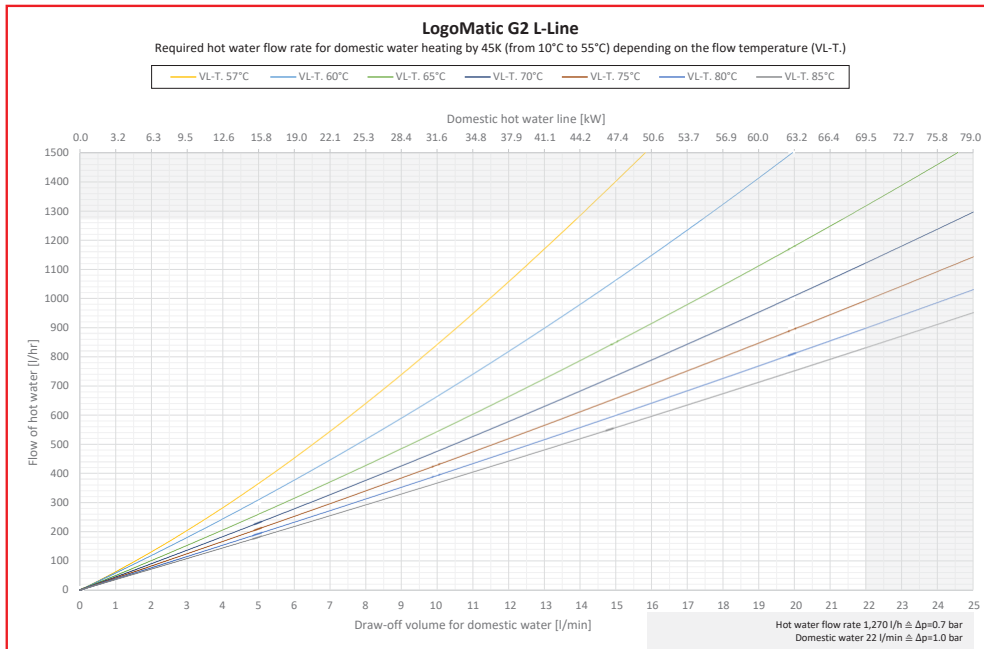



Hot water preparation from 10°C to 60°C (50 Kelvin)

Primary flow temperature for heating [°C]				62	65	70	75	80	85
Hot water output [l/min]	-	-	-	13.7	17.0	20.8	22.0	22.0	22.0
Hot water output [kW]	-	-	-	47.8	59.3	72.5	76.6	76.6	76.6
Primary volume flow for heating [l/min]	-	-	-	21.2	21.2	21.2	19.3	17.2	15.6
Primary return line temperature [°C]	-	-	-	30	25	21	18	16	15
Primary pressure loss [kPa]	-	-	-	70	70	70	58	46	38
Pressure loss for domestic water [kPa]	-	-	-	40	62	92	100	100	100
Calculated mixed water at 38 °C ¹⁾ [l/min]	-	-	-	24.5	30.4	37.2	39.3	39.3	39.3

¹⁾ The calculated mixed water volume is an indication of the maximum achievable water volume at 38°C (draw-off at the individual draw-off points and not at the station).

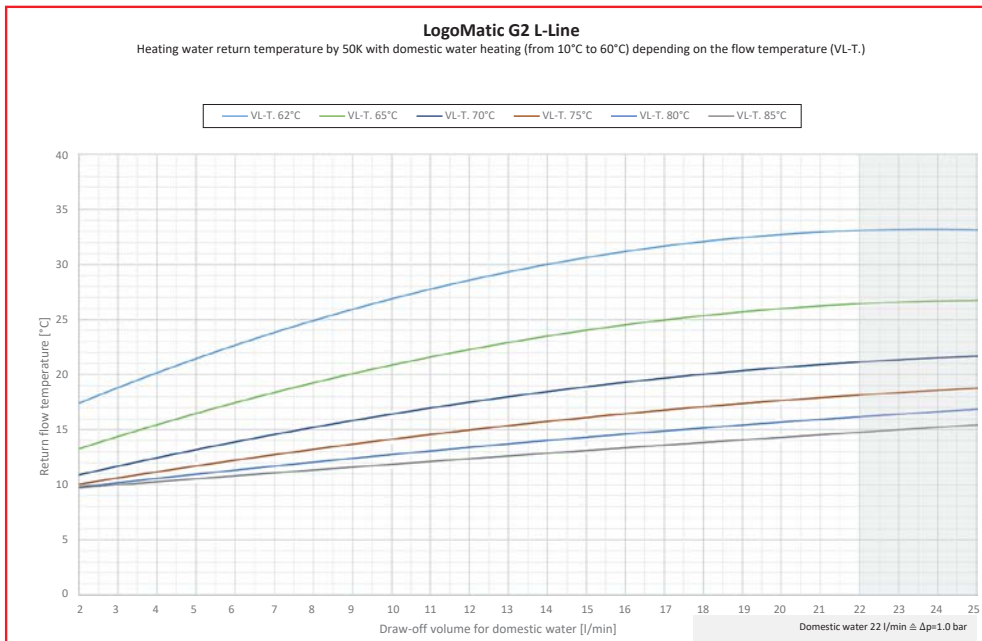
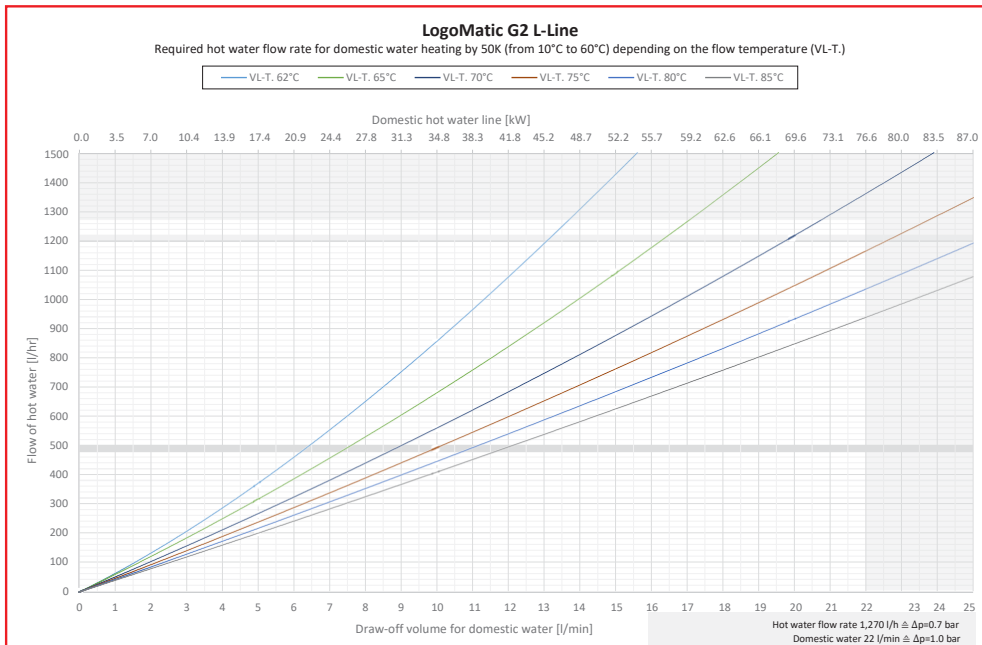

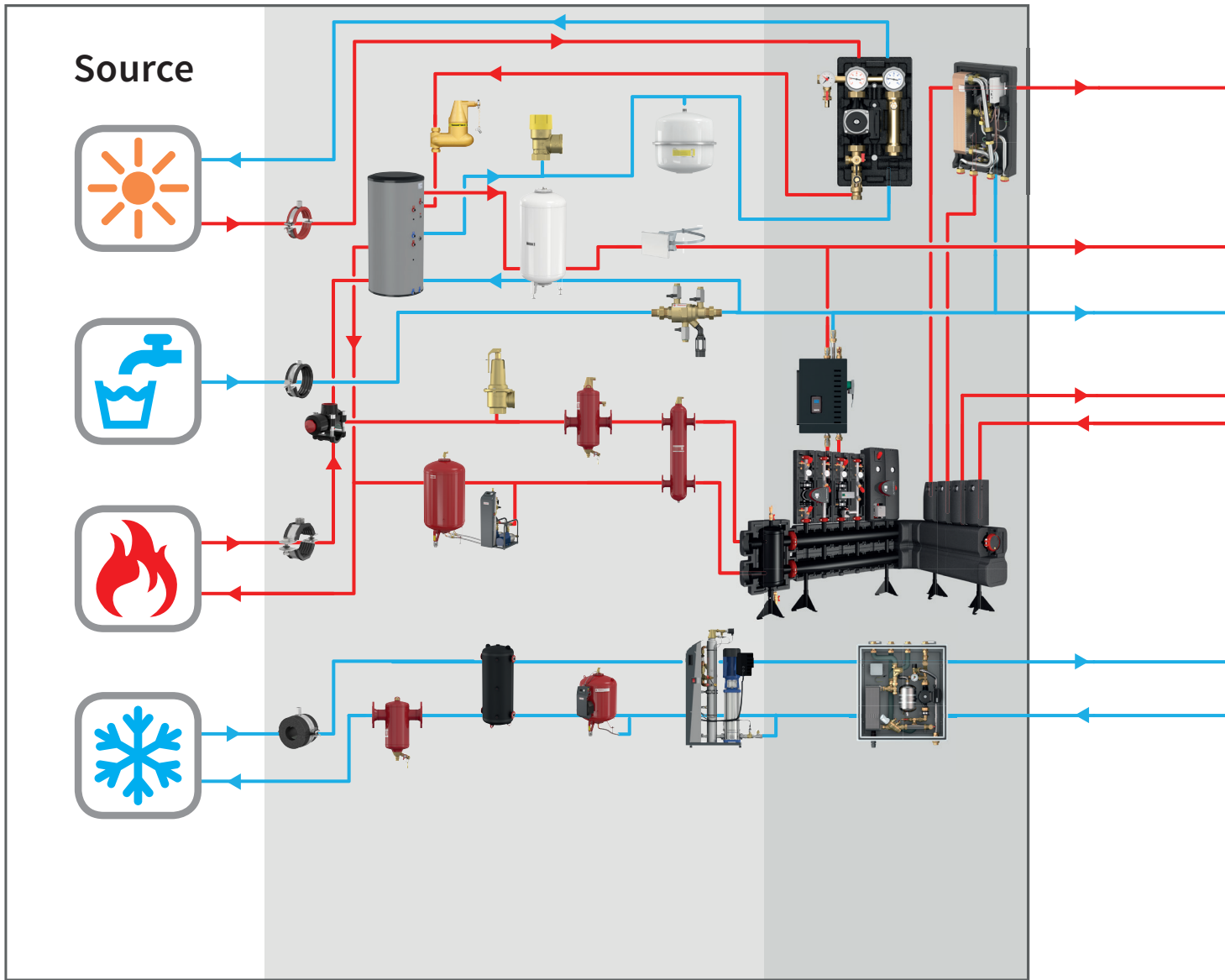

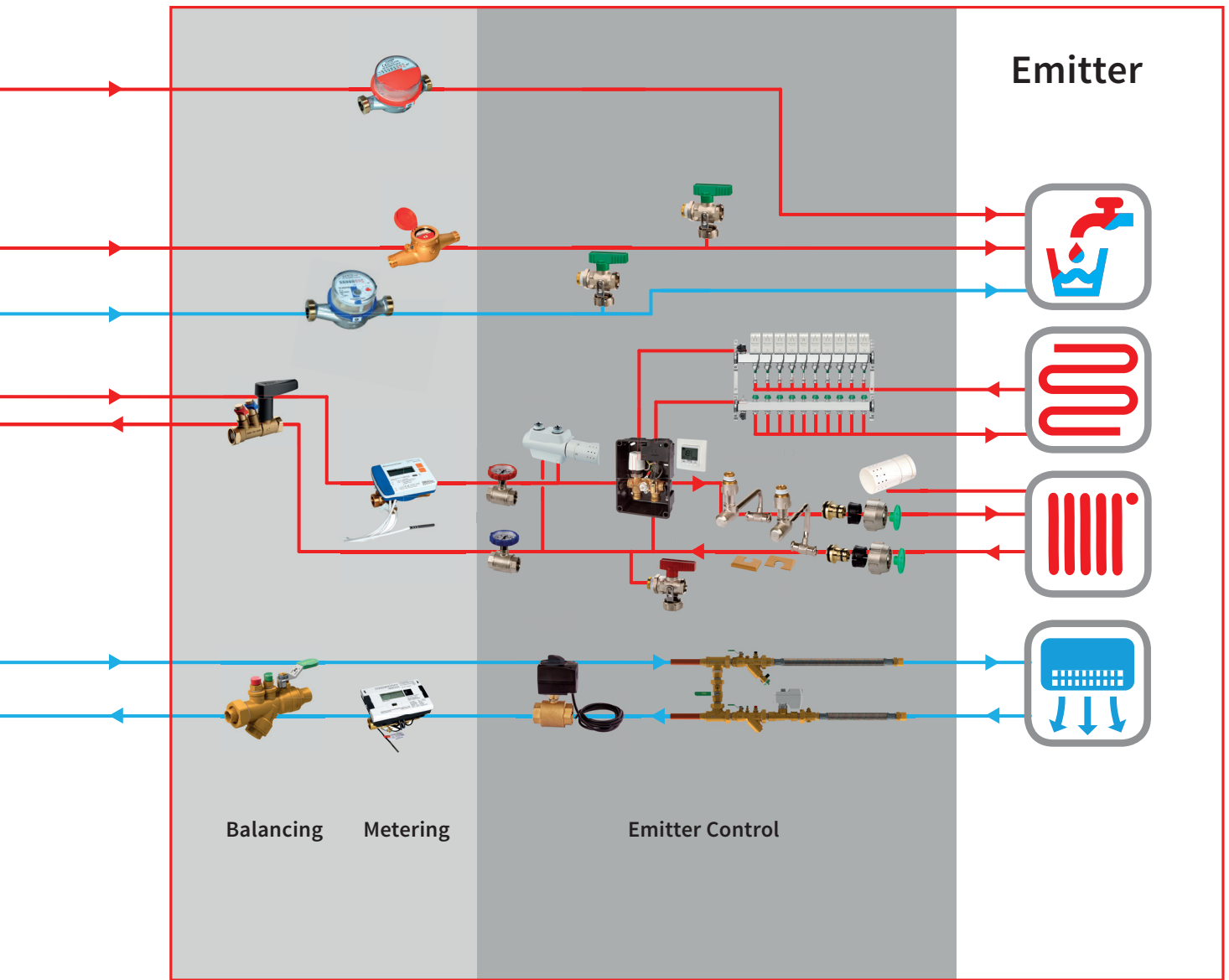



We deliver products for plumbing and heating installers in over 70 countries. Sales are handled by the branches and wholesalers who know the local market and can offer you professional advice at any time.



Germany

info@flamco.de
www.flamco.de

Austria

info@flamco.at
www.flamco.at

Switzerland

info@flamco.ch
www.flamco.ch