



flamco

that's excellence.

Fresh water stations Planning aid

We are experts in domestic water solutions

Fresh water station and complementary products:

- Central domestic water heater designed according to the latest hygienic standard
- Individual outputs up to 125 l/min. and option for cascading (up to 5 pieces)
- Domestic hot water preparation with and without domestic hot water circulation
- As a fully electronic or thermostatic solution



Microprocessor-controlled



Thermostat-controlled



Contents

	Page
Introduction, advantages and concept	4–9
Fresh water stations in general	4
Domestic water quality	5
Comparison	6
The supply concept	8
Volume flows in residential buildings	9
LogoFresh fresh water stations	10-26
Overview of LogoFresh electronic	10
Overview of LogoFresh thermostatic	11
LogoFresh electronic performance ranges	12
LogoFresh electronic connection types	13
LogoFresh electronic S-Line, M-Line & L-Line technical data	15
LogoFresh electronic XL-Line technical data	16
LogoFresh electronic S-Line, M-Line & L-Line complementary products	17
LogoFresh electronic S-Line performance data	18
LogoFresh electronic M-Line performance data	19
LogoFresh electronic L-Line performance data	20
LogoFresh electronic XL-Line performance data	21
LogoFresh thermostatic performance ranges	22
LogoFresh thermostatic connection types	23
LogoFresh thermostatic S-Line technical data	24
LogoFresh thermostatic S-Line performance data	25
LogoFresh thermostatic M-Line performance data	26
Heating system components	27–28
Buffer tank PS500 to PS2000 introduction	27
Buffer tank PS500 to PS2000 type overview	28
Components for solar systems	29–32
Solar separation system – XL-Line versions	29
Solar separation system – XL-Line technical data	30
Solar separation system – XXL-Line	31
Solar controller	32

LogoFresh fresh water stations

The LogoFresh fresh water stations are compact, plug-and-play units that enable centralised, hygienic and economical domestic hot water heating because they prepare hot water on demand.

Fresh water stations can be used to supply fresh domestic hot water to single- or multiple-occupancy dwellings and publicly or privately used premises, such as schools, sports facilities or hospitals. The principle of on-demand fresh hot water production is particularly useful in buildings that are used intermittently.

The energy is supplied by a heating water buffer tank, which can also be fed from renewable energy sources (e.g. solar systems, etc.), and this contributes to the overall energy efficiency of the building.

Other advantages of electronically controlled variants:

- Disinfection (Legionella protection control)
- Data-logging
- Fault indicator
- Mixing protection function on heating water buffer tank



Advantages

- No cold domestic water tank required
- Space-saving, quick and simple installation
- High hot water output at a constant temperature of up to 125 l/min.
- Cascadable and connected in parallel
- High efficiency due to low return temperature (with optional return temperature stratification)

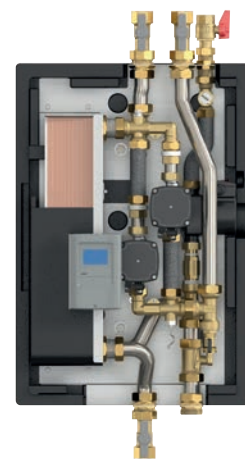
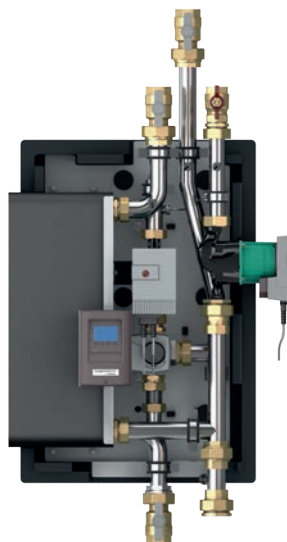
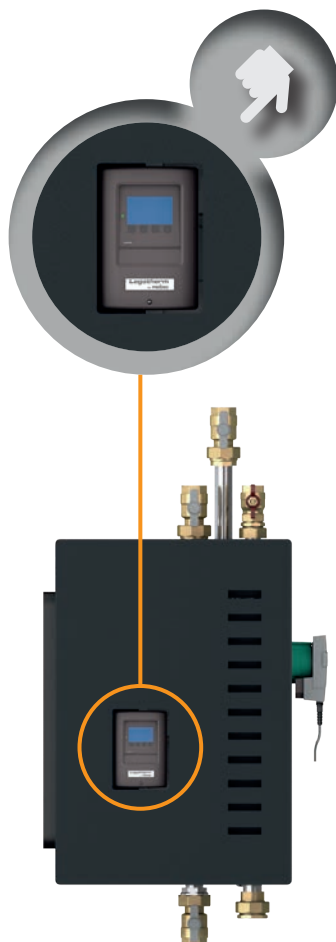

Domestic water quality

"Water intended for human consumption must be of such a quality that its consumption or use is not likely to cause harm to health".

– German Law on Protection against Infection (IfSG) Art. 37(1)

Hot water is heated on demand by a LogoFresh fresh water station using the flow principle.

This does not involve the use of an improperly operated or unclean domestic water tank. The omission of this tank also eliminates the risk of domestic water tanks that are not properly flown through and are oversized, which also means that there are no long stagnation times for domestic water and the associated increased risk of germ formation within the hot water tank! Furthermore, the omission of the domestic hot water tank eliminates one of two decision criteria regarding the evaluation of the system into a small system and a large system based on the specifications of DVGW worksheet W551 and, if a small system is achieved, there is no need for testing (as per Art. 14(3) of the German Drinking Water Regulation, TrinkwV).

LogoFresh fresh water stations are available with and without domestic water circulation, depending on the product type, in order to meet the requirements of the 3 litre rule (decision criterion for evaluation in small and large systems). The LogoFresh fresh water stations (electronically controlled) allow individual circulation times to be set (among other things, to take into account the specified minimum running times per day of ≥ 16 hours).

The LogoFresh fresh water stations (electronically controlled) control the domestic hot water outlet temperature and thus help to comply with specifications and comfort needs! Furthermore, the LogoFresh fresh water stations (electronically controlled) allow the operator to configure settings according to their needs.

The LogoFresh XL-Line fresh water stations (electronically controlled) can monitor the circulation temperature depending on the product type.

Building type	Domestic water heater pipe volume up to draw-off point	Definition
Single and dual occupancy dwelling	Irrelevant	Small system
Other building	≤ 3 litres	Small system
	> 3 litres	Large system

Pipe dimension	Pipe content/metre	Pipe length/litre capacity	3 litre pipe capacity corresponds to a pipe length of...
[mm]	[l/m]	[m/l]	m
10 x 1.0	0.050	19.89	59.68
12 x 1.0	0.079	12.73	38.20
15 x 1.0	0.133	7.53	22.60
18 x 1.0	0.201	4.97	14.92
22 x 1.0	0.314	3.18	9.55
28 x 1.0	0.531	1.88	5.65
28 x 1.5	0.491	2.04	6.11
32 x 1.5	0.804	1.24	3.73

When evaluating large systems with regard to the requirement for the integration of domestic hot water circulation, the pipe content volume between the outlet of the domestic water heater and the last draw-off point must be taken into account! **The content of a circulation pipe itself and the content of the domestic hot water heater (PHE) are not taken into account.**

We are not liable for the actuality or completeness of any of these lists.

The comparison

Hot water storage tank

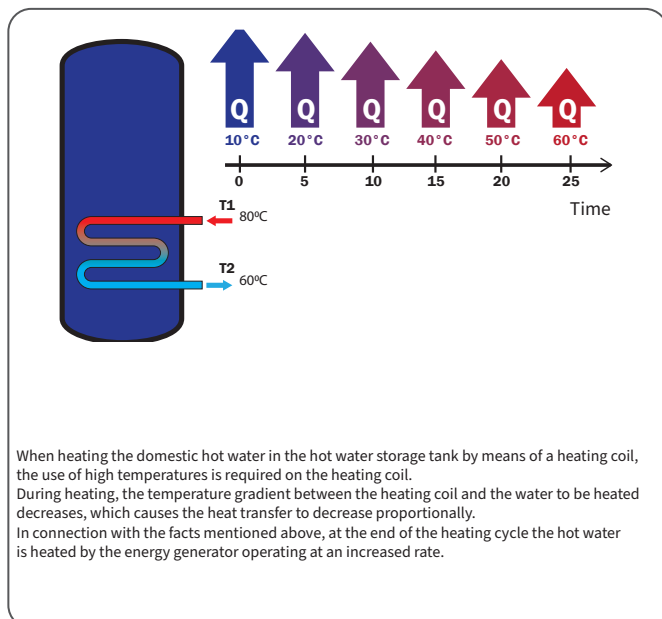
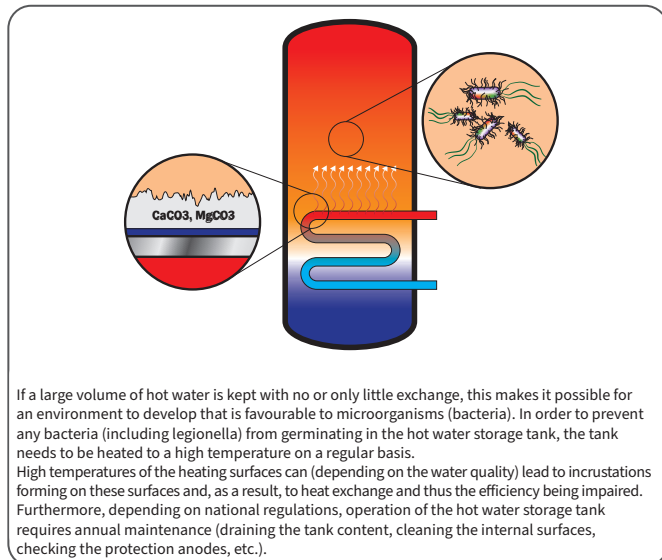
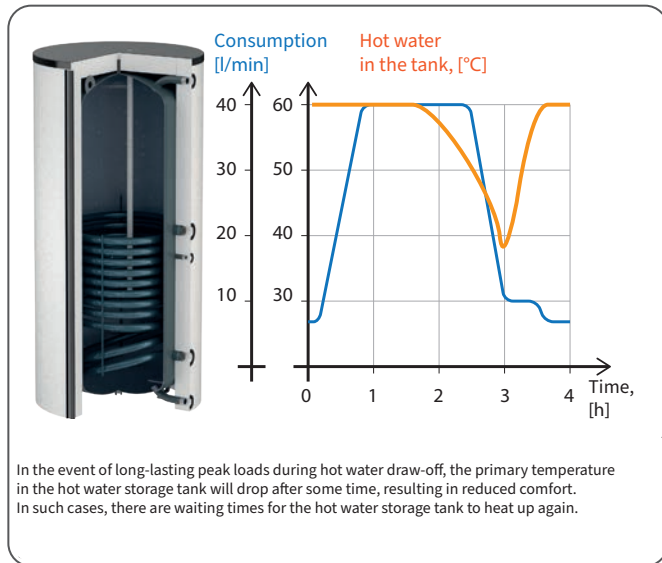

The comparison

LogoFresh for hot water preparation

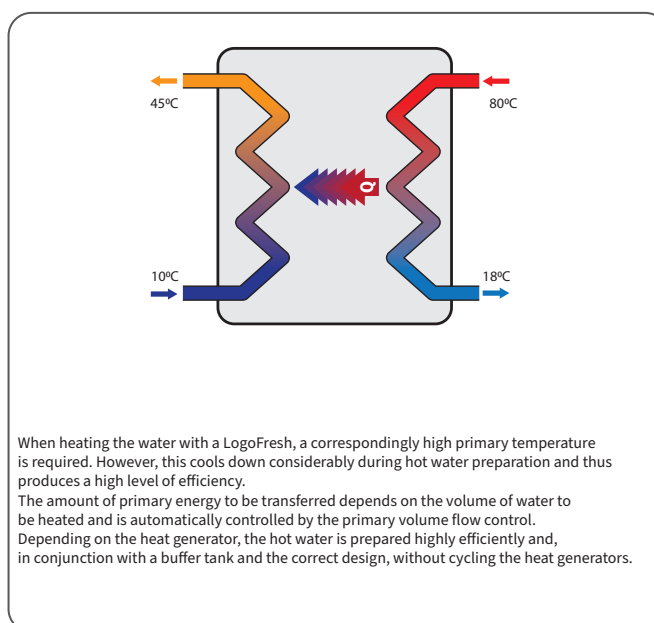
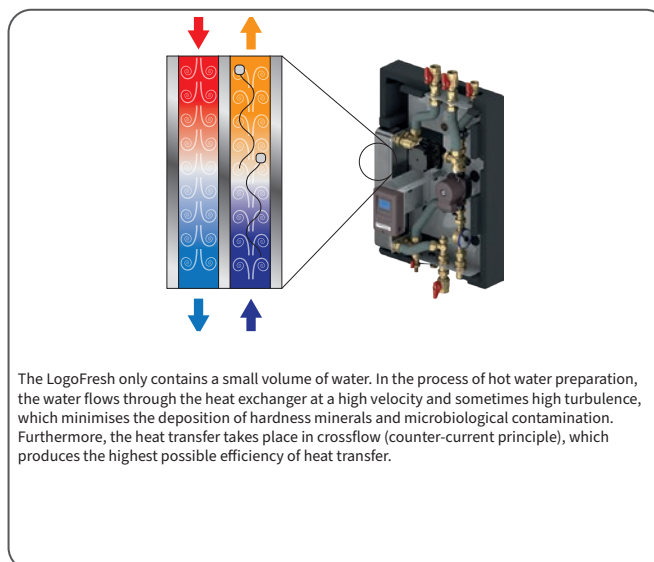
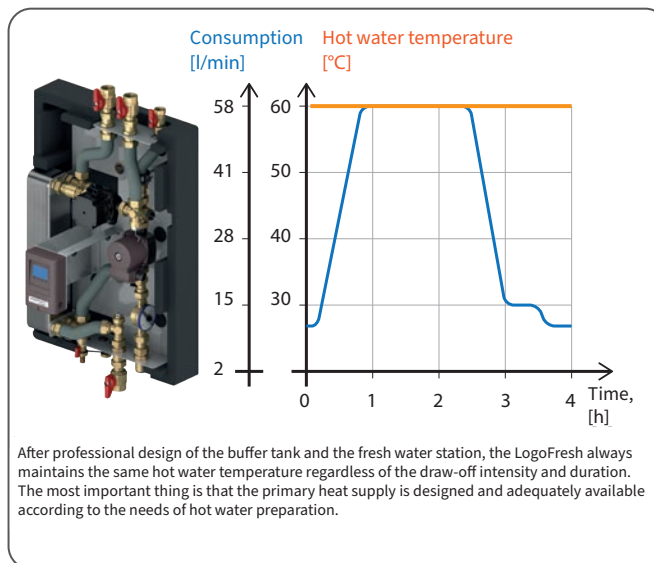

The supply concept

The LogoFresh fresh water stations are connected to a heating water buffer tank. They are connected to the heating flow and return lines as well as to the cold and hot water pipes. If necessary, the station is connected to the domestic water circulation. The LogoFresh fresh water station completely takes over the function of the hot water preparation. Depending on the model and application, it can be designed so that a large number of draw-off points can be supplied at the same time. Hot water is prepared via a plate heat exchanger using the continuous flow principle, resulting in hygienic hot water preparation. LogoFresh thus complies with the latest hygienic standards because the hot water is prepared according to consumption and without storing hot water in large tanks.

The system demonstrates a number of environmental as well as economic benefits. The system is thermally efficient, supports renewable energies such as solar, and heat pumps, PV-powered electric heating inserts or wood heaters with a water pocket can be easily integrated into the buffer tank.

- W1** Flamco-Meibes safety module
- W2** Flamco-Meibes cascade set
- W3** Flamco-Meibes LogoFresh fresh water station

- H1** Heat generator
- H2** Flamco-Meibes cascade
- H3** Flamco-Meibes boiler guard
- H4** Flamco-Meibes buffer tank
- H5** Flamco-Meibes pressure degassing
- H6** Flamco-Meibes pump group
- H7** Flamco-Meibes circuit control valve (NexusValve)

- S1** Solar collectors
- S2** Flamco-Meibes solar controller (e.g. PRO version)
- S3** Flamco-Meibes solar station (e.g. solar separation system XL/XXL)
- S4** Flamco-Meibes solar expansion vessel

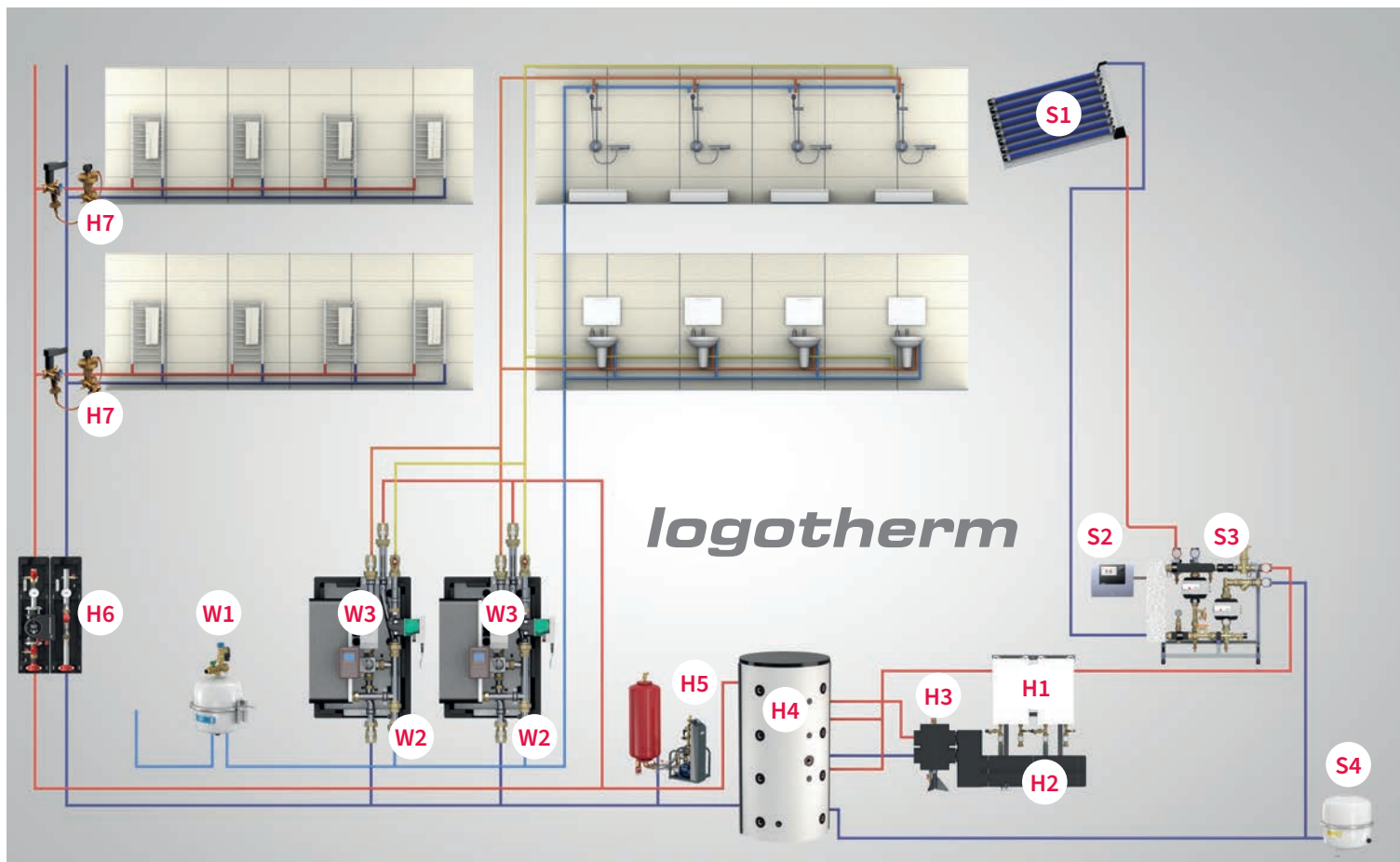

Volume flows in residential buildings

Depending on the type of building and use, the maximum volume flows to be calculated for each building may differ based on standardisation requirements with regard to the design. The basis for dimensioning is DIN 1988:300 with the defined calculation methods and the constants defined therein for peak volume flow determination. The following diagram shows theoretically calculated maximum peak flows (note: no total flows) in l/min. For the following assumptions, the peak flows of the draw-off points are shown depending on the residential units per property.



Theoretical assumptions per residential unit			Assumption 1	Assumption 2	Assumption 3
Bathtub (WA) or shower (DU)	0.15 l/s	Σ	1	2	2
Kitchen sink	0.1 l/s	Σ	1	1	2
Washbasin	0.07 l/s	Σ	1	1	2

LogoFresh electronic S-Line, M-Line, L-Line & XL-Line

The electric control systems operate with a microprocessor-regulated controller which ensures immediate hot water preparation on draw-off thanks to temperature-based regulation of the primary flow rate.



Advantages

- Extremely wide range of adjustable comfort functions¹ (e.g. disinfection switching, tank reheating function, commissioning assistant, fault message display, display of statistics and graphic evaluations)
- Precise setting of HW temperature to the degree and indication of the operating statuses on the display
- Increased performance due to the simple electronic cascading of up to five fresh water stations (LogoFresh M-Line, L-Line and XL-Line only)
- Regulates to the set hot water temperature, regardless of changes in cold water or primary temperature (e.g. summer/winter operation)
- Optional fault indicator with data-logging (via optional accessories)

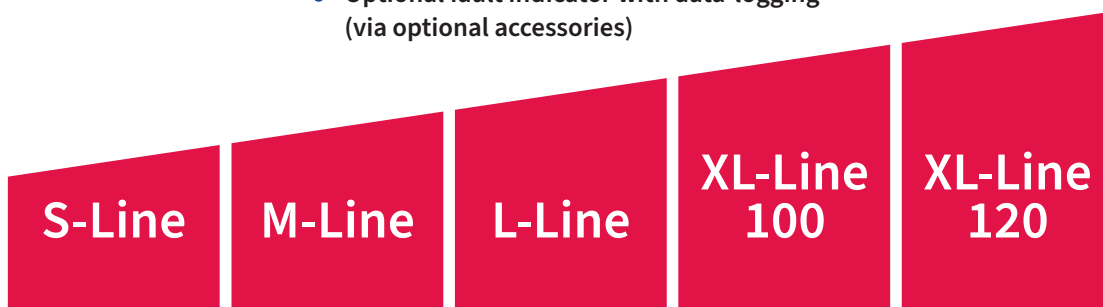

Type of assembly	Wall Tank	S-Line	M-Line	L-Line	XL-Line 100	XL-Line 120
EPP housing	✓	✓	✓	✓	✓	✓
Domestic water circulation	✓	✓ ²	✓ ²	✓ ²	✓	✓
Autom. disinfection ¹			✓	✓	✓	✓
Tank reheating function ¹			✓	✓	✓	✓
Mixing protection			✓	✓	✓	✓
Fault indicator ¹			✓	✓	✓	✓
Data-logging			✓	✓	✓	✓
Σ max. cascade		–	5 ¹	5 ¹	5 ¹	5 ¹

1) Functions are product-dependent and individual functions may be selected, but only a limited number may be selected for each system.

Please ask us for the possible combinations.

2) These products are available with and without the stated technical configuration. For further information please refer to the respective product pages.

LogoFresh thermostatic S-Line & M-Line

The thermostatic control systems operate in a temperature-controlled manner, by means of a thermostatic valve and ensures constant hot water supply on draw-off thanks to temperature-based regulation of the primary volume flow.



Advantages

- Easy commissioning and operation
- Easy maintenance and fault diagnosis
- Always regulates to the set hot water temperature, regardless of changes in cold water or primary temperature (e.g. summer/winter operation).



S-Line

M-Line

Type of assembly	Wall	✓	
	Tank	✓	
EPP housing		✓	✓
Domestic water circulation		✓ ²	✓ ²
Autom. disinfection ¹			
Tank reheating function ¹			
Mixing protection			
Fault indicator ¹			
Data-logging			
Σ max parallel connection		4	4

1) Functions are product-dependent and individual functions may be selected, but only a limited number may be selected for each system.

Please ask us for the possible combinations.

2) These products are available with and without the stated technical configuration. For further information please refer to the respective product pages.



LogoFresh electronic

Output ranges according to HW temperature

LogoFresh electronic performance diagram for 45°C hot water temperature

- S-Line
- M-Line
- L-Line

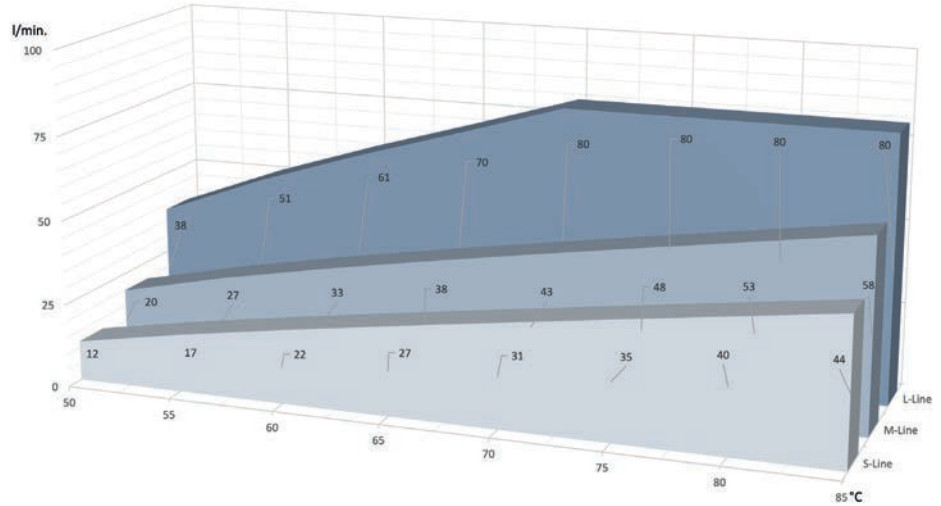

LogoFresh electronic performance diagram for 50°C hot water temperature

- S-Line
- M-Line
- L-Line
- XL-Line 100
- XL-Line 120

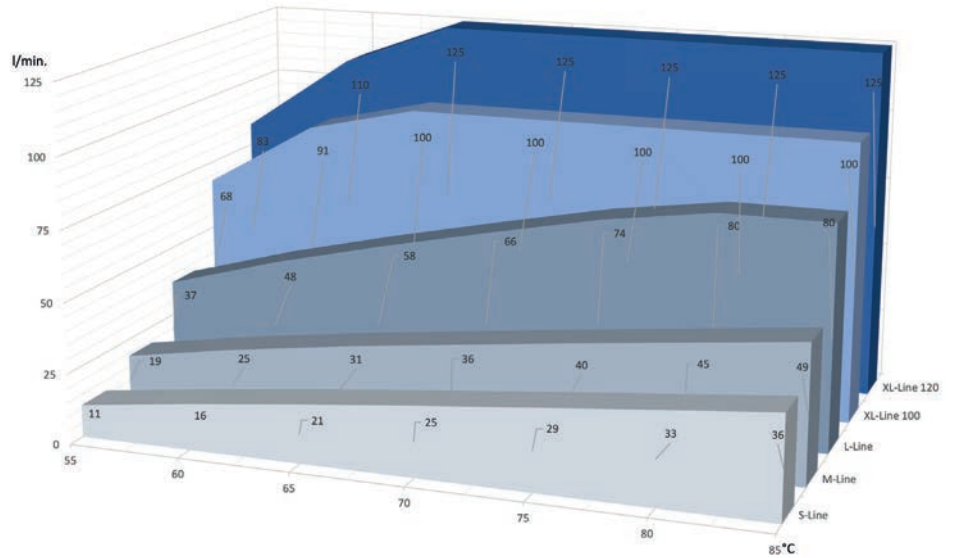

LogoFresh electronic performance diagram for 60°C hot water temperature

- S-Line
- M-Line
- L-Line
- XL-Line 100
- XL-Line 120

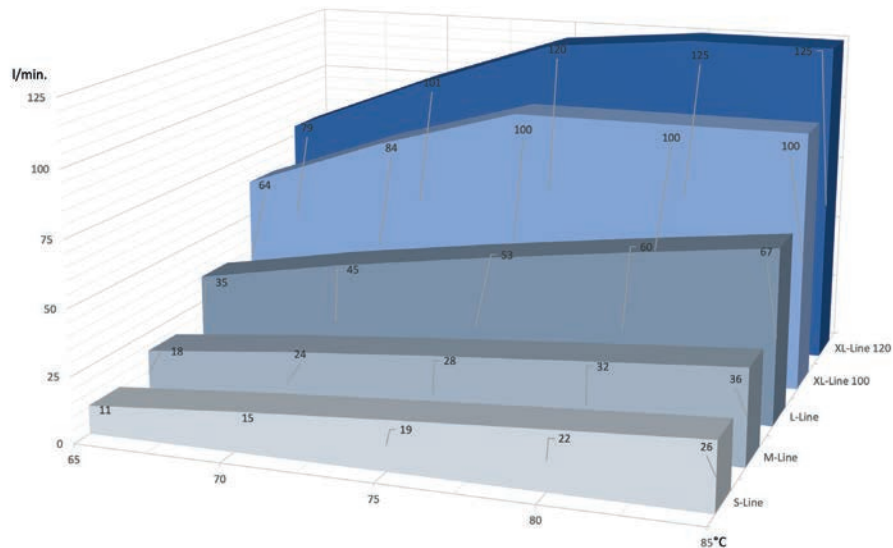



Connection types

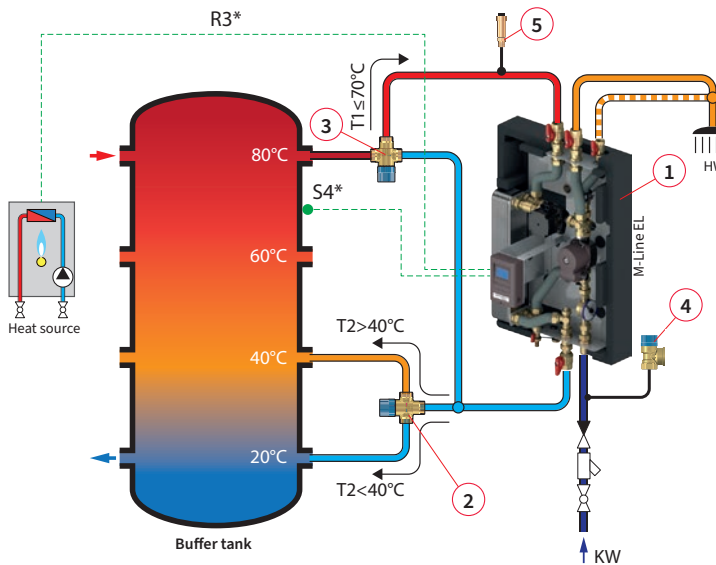

Integration example for a single system using the LogoFresh M-Line electronic as an example

Designations:

1. LogoFresh M-Line with domestic hot water circulation
2. LogoFresh M RT switching module (return single-layer module, electronically controlled, for temperature-controlled layering)
3. Flow line pre-mix module (thermostatically controlled) FLAMCOMIX HC 20-70°C
4. Safety valve Prescor 1/2", 6 bar
5. Automatic air vent

Remarks:

- 1) To use the LogoFresh M RT switching module (no. 2): When, for example, a small volume of hot water is being drawn off or during operation of the LogoFresh with corresponding flow temperatures, the return line temperature may be higher. In this case, it is recommended for the return line heating water to be fed into a different temperature zone in the buffer tank to prevent mixing and thus increase efficiency.
- 2) To use the flow line pre-mix module (no. 3): The installation can be performed if the buffer tank is to be heated to >80°C. It prevents blocking of the feed pump due to excessive heating during low water draw-off.
- 3) On the domestic water side, the corresponding safety devices according to DIN must be provided upstream of the LogoFresh.
- *) The LogoFresh M-Line is set to autonomous operation by default. For the purpose of monitoring the temperature of the buffer tank, a temperature sensor S4 (option) must be retrofitted and the "potential-free contact" (R3) must be connected to the LogoFresh controller and activated.

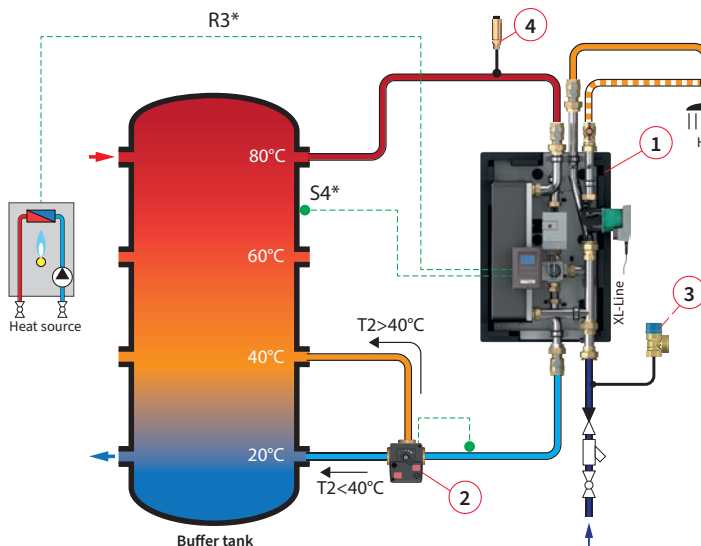

Integration example using single system as an example LogoFresh XL-line electronic

Designations:

1. LogoFresh XL-Line with domestic hot water circulation
2. LogoFresh XL RT switching module (return single-layer module, electronically controlled, for temperature-controlled layering)
3. Safety valve Prescor 3/4", 6 bar
4. Automatic air vent

Remarks:

- 1) To use the LogoFresh XL RT switching module (no. 2): When, for example, a small volume of hot water is being drawn off or during operation of the LogoFresh with corresponding flow temperatures, the return line temperature may be higher. In this case, it is recommended for the return line heating water to be fed into a different temperature zone in the buffer tank to prevent mixing and thus increase efficiency.
- 2) On the domestic water side, the corresponding safety devices according to DIN must be provided upstream of the LogoFresh.
- *) The LogoFresh XL-Line is set to autonomous operation by default. For the purpose of monitoring the temperature of the buffer tank, a temperature sensor S4 (option) must be retrofitted and the "potential-free contact" (R3) must be connected to the LogoFresh controller and activated.



LogoFresh electronic

Connection types

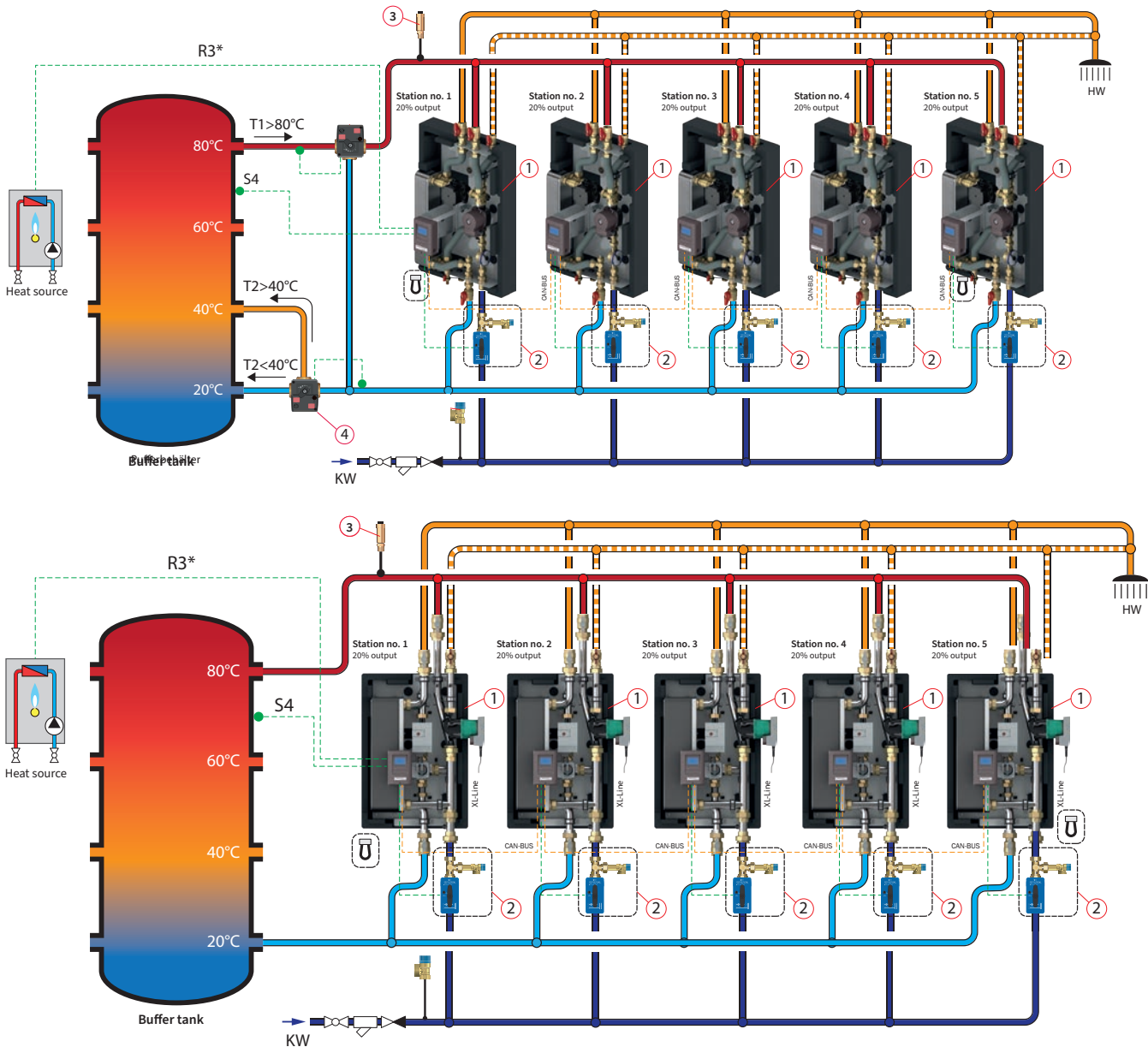

Integration example using cascade connection as an example LogoFresh M-Line as well as XL-Line electronic

Designations:

1. LogoFresh M-Line, L-Line and XL-Line with domestic hot water circulation
2. Cascade set
3. Automatic air vent
4. Return single-layer module

Remarks:

- 1) Up to five stations can be connected together in a cascade circuit.
Caution: Only the same station type can be combined.
- 2) Cascading of the LogoFresh S-Line is not possible!
- 3) One advantage of cascading is that a duty rotation can be carried out automatically (note: this may only be possible under certain conditions, such as the integration of the domestic hot water circulation), resulting in comparable operating hours.
- 4) A cascade set is installed along the cold water line upstream of each LogoFresh and includes a safety valve.
The LogoFresh controllers are connected to each other with a special cable via the bus system (CAN-BUS).
- *) The "potential-free contact" (R3) can be used either to output a signal to the heat source for reheating the buffer tank or to output an alarm.

LogoFresh electronic S-Line, M-Line & L-Line

Technical data

Compact, ready-to-fit, central fresh water stations with electronically controlled hot water preparation for wall mounting. The M-Line and L-Line versions are electronically cascadable and allow even higher outputs to be attained in correlation with the respective application.



Equipment features and technical data LogoFresh electronic S-Line & M-Line	S-Line		M-Line		L-Line	
	Type 1	Type 2	Type 1	Type 2	Type 1	Type 2
Dimensions incl. housing (W×H×D in mm)	455×660 ¹ ×215		500×890 ¹ ×340		500×965 ¹ ×340	
Max. pressure: heating/sanitary	PN 10/PN 10					
Max. permissible temperatures: heating/sanitary	110°C					
Supply voltage	230V/50Hz					
Bottom connections (Cold water inlet & primary heating return line)	3/4"		1"		1 1/4"	
Top connections (Hot water outlet & primary heating flow line)	3/4"		1"		1 1/4"	
Top connection (domestic hot water circulation)	-	3/4"	-	3/4"	-	1"
Wall mounting	✓					
Electronic controller for constant temperature regulation depending on the set hot water temperature and draw-off capacity by modulating the heating circuit pump	✓					
Stainless-steel plate heat exchanger, vertical design to reduce the risk of calcification	✓					
Achieves lower return line temperatures	✓					
Bleed valve on the heating side	✓					
Backflow preventer	✓					
Shut-off valves (except for cold water inlet)	✓					
Pipes made of stainless steel (partially pre-insulated)	✓					
Mounted entirely mechanically tension-free on base plate, inserted in housing and inspected	✓					
Pressure flow sensor	✓					
Full EPP insulation of housing (black)	✓					
Heating side high-efficiency recirculation pump	1		1		2	
Domestic water circulation with pump, backflow preventer, piping and screw fitting components installed in the station and connected to the controller	-	✓	-	✓	-	✓
With integrated disinfection (legionella protection)	-		-	✓	-	✓
With integrated heat retention function (heat exchanger)	-				✓	
Tank reheating function ²	-				✓	
Mixing protection function for heating water buffer tank ²	-				✓	
Fault indicator ²	-				✓	
Number of possible electronically controlled cascades²	-				5	
Data logging via data logger	-				✓	
Intuitive menu navigation and multilingual controller	✓					
"Display monochrome multifunction graphics on LCD display with background lighting"	✓					
Animated schematic of the systems and operating states	✓					
Statistics and graphical evaluation from data memory	✓					
Menu languages: German, English, Spanish, French, Dutch, Italian, Czech, Polish, Russian	✓					
"Insulation wedges for tank installation – connectible wedges for pre-formed rear-wall insulation for mounting directly onto a tank (tank $\varnothing \geq 600$ mm)"	✓				-	



Fig.1



Fig. 2



Fig.3

Station	Typ	Description	Fig.	Art.-No. type of PHE	
				copper soldered	coated ³ or stainless steel soldered
S-Line	1	LogoFresh S-Line electronic	-	M10270.62	M10270.64
S-Line	2	LogoFresh S-Line electronic with DHW circulation	2	M10270.63	M10270.65
M-Line	1	LogoFresh M-Line electronic	-	M10270.52	M10270.54
M-Line	2	LogoFresh M-Line electronic with DHW circulation	1	M10270.53	M10270.55
L-Line	1	LogoFresh L-Line electronic	-	M10270.91	M10270.93
L-Line	2	LogoFresh L-Line electronic with DHW circulation	3	M10270.92	M10270.94

- ¹⁾ Incl. shut off ball valves
²⁾ Individual functions may be freely selected, but only a limited number may be selected for each system. Please ask us for the possible combinations.

³⁾ Coated or stainless steel soldered heat exchangers for a more proper resistance to difficult water qualities (including conductivity $>500\mu\text{S/cm}$)



LogoFresh electronic XL-Line

Technical data

Compact, ready-to-fit, central fresh water stations with electronically controlled hot water preparation. The LogoFresh XL-Line fresh water stations are available as compact units with full insulation.

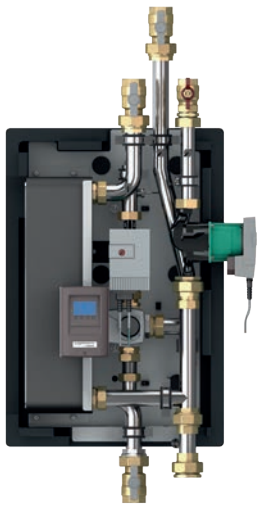

LogoFresh XL-Line 100

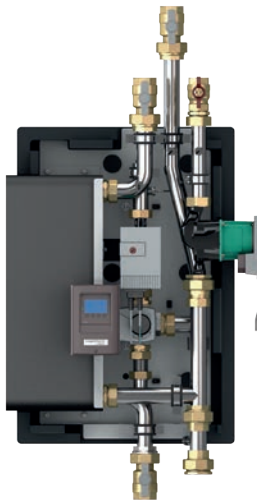

LogoFresh XL-Line 120

Equipment features and technical data LogoFresh XL-Line	XL-Line 100	XL-Line 120
Dimensions incl. housing (W×H×D in mm)	500×1,137 ¹ × 340	600×1,137 ¹ × 340
Max. pressure: heating/sanitary	PN 10/PN 10	
Max. permissible temperatures: heating/sanitary	90°C	
Supply voltage	230V/50Hz	
Connections for cold water, hot water, flow line & return line from buffer	1½"	
Connections for domestic hot water circulation	1¼"	
Wall mounting	✓	
Electronic fresh water station with variably mountable control panel for constant hot water temperature regulation depending on the set hot water temperature and draw-off capacity by modulating the heating circuit pump	✓	
Stainless-steel plate heat exchanger, vertical design to reduce the risk of calcification	✓	
Achieves lower return line temperatures	✓	
Heating side high-efficiency recirculation pump	✓	
Bleed valve on the heating side	✓	
Backflow preventer	✓	
Shut-off valves (except for cold water inlet)	✓	
Pipework made from stainless steel fixed piping (smooth)	✓	
Mounted entirely mechanically tension-free on base plate, inserted in housing and inspected	✓	
Programmable domestic water circulation with high-efficiency pump, backflow preventer and piping and screw fitting components installed in the station and connected to the controller	✓	
Pressure flow sensor	✓	
With integrated disinfection (legionella protection control) ²	✓	
With integrated heat retention function (heat exchanger)	✓	
Tank reheating function ³	✓	
Mixing protection for heating water buffer tank ²	✓	
Fault indicator ²	✓	
Housing: Full EPP insulation of housing (black)	✓	
Number of possible electronically controlled cascades²	5	
Data logging via data logger	optional	
Intuitive menu navigation and multilingual controller	✓	
Display monochrome multifunction graphics on LCD display with background lighting	✓	
Animated schematic of the systems and operating states	✓	
Statistics and graphical evaluation from data memory	✓	
Menu languages: German, English, Spanish, French, Dutch, Italian, Czech, Polish, Russian	✓	

¹) Incl. shut off ball valves

²) Individual functions may be freely selected, but only a limited number may be selected for each system. Please ask us for the possible combinations.

³ Coated heat exchangers for a more proper resistance to difficult water qualities (including conductivity >500µS/cm).

Station	Description	Fig.	Art.-No. type of PHE	
			copper soldered	coated ³
XL-Line	LogoFresh XL-Line 100 electronic	1	M10270.81	M10270.82
XL-Line	LogoFresh XL-Line 120 electronic	2	M10270.71	M10270.72

LogoFresh electronic S-Line, M-Line & L-Line



Complementary products			
Description	Application	Fig.	Art. no.
LogoFresh M-Line cascade set, suitable for direct connection to LogoFresh M-Line, incl.: 1x valve DN25 (supply voltage 230 V, suitable for domestic water) 1x safety valve 10 bar 1x T-piece for connection to SI valve 1x CAN connection cable"	M-Line	Fig. 1	M10270.521
LogoFresh L & XL-Line cascade set, suitable for direct connection to LogoFresh L or XL-Line, incl.: 1x valve DN32 (supply voltage 230V, suitable for domestic water) 1x safety valve 10 bar 1x T-piece for connection to SI valve 1x CAN connection cable"	L & XL-Line	Fig. 1	M10270.711
LogoFresh M RT Switching module (Return single-layer module)	M-Line	Fig. 5	M10270.522
LogoFresh L RT Switching module (Return single-layer module)	L-Line	Fig. 6	M10270.912
LogoFresh XL RT Switching module (Return single-layer module)	XL-Line	Fig. 6	M10270.712
Prescor B 3/4" (membrane safety valve), 10 bar, heat output up to 150kW	S, M & L-Line ¹	Fig. 2	27117
Prescor B 1" (membrane safety valve), 10 bar, heat output up to 250kW	S, M & L-Line ¹	Fig. 2	29007
FLAMCOMIX HC 20-70°C as thermostatic flow line pre-mix module DN25 as well as 1 1/4", setting 30°C-70°C, Kvs 6.1	S, M & L-Line ²	Fig. 3	28780
Overflow valve for hydraulically controlled connection (parallel connection of the stations)	S-Line	Fig. 4	M69072.9



Fig. 1

¹ Observe the maximum specifications for the heat output of the safety valve and thus the max. number of LogoFresh to be supplied as cascading!

² Max. Kvs value and thus the max. number of LogoFresh to be supplied as cascading!



Fig. 2



Fig. 3



Fig. 4



Fig. 5



Fig. 6



LogoFresh electronic S-Line

Performance data

Basic criteria for design/calculation:

Cold water temperature:	°C	10
Critical draw-off duration:	Min.	10
Heat source activation time:	Min.	3
Buffer tank recharging time:	Min.	30
Cycle time:	Min.	40
Free boiler output (100% priority switching):	%	100

All of the specifications are intended to facilitate the design process and must be checked before implementation.

LogoFresh S-Line electronic – performance table											
Domestic water heating Around 35K (10-45°C)	Flow line temperature primary	°C	50	55	60	65	70	75	80	85	
	Return line temperature primary	°C	35	33	32	31	30	30	29	29	
	Domestic hot water draw-off volume	l/min	12	17	22	27	31	35	40	44	
	Domestic hot water output	kW	29	42	54	65	76	86	96	107	
	Primary flow rate	l/h	1642								
	Primary pressure loss	bar	0.30								
	Primary residual delivery head	bar	0.15								
	Secondary pressure loss	bar	0.18	0.31	0.45	0.60	0.81	1.07	1.32	1.58	
	Proposal for buffer tank type ^{1,2}	Type	PS500								
	Proposal for primary energy output ^{1,2}	kW	8	11	15	18	20	23	26	29	
	Max. mixed water temperature (10-38°C) ³	Litres	15	22	28	33	39	44	49	55	

Domestic water heating Around 40K (10-50°C)	Flow line temperature primary	°C		55	60	65	70	75	80	85	
	Return line temperature primary	°C		38	36	35	34	33	32	32	
	Domestic hot water draw-off volume	l/min		11	16	21	25	29	33	36	
	Domestic hot water output	kW		32	46	58	69	80	91	101	
	Primary flow rate	l/h	1642								
	Primary pressure loss	bar	0.30								
	Primary residual delivery head	bar	0.15								
	Secondary pressure loss	bar		0.15	0.28	0.41	0.54	0.73	0.90	1.10	
	Proposal for buffer tank type ^{1,2}	Type	PS500								
	Proposal for primary energy output ^{1,2}	kW		9	12	16	19	22	25	27	
	Max. mixed water temperature (10-38°C) ³	Litres		16	23	30	35	41	47	52	

Domestic water heating Around 50K (10-60°C)	Flow line temperature primary	°C			65	70	75	80	85		
	Return line temperature primary	°C			46	43	41	39	38		
	Domestic hot water draw-off volume	l/min			11	15	19	22	26		
	Domestic hot water output	kW			37	52	65	78	89		
	Primary flow rate	l/h	1642								
	Secondary pressure loss	bar	0.30								
	Primary residual delivery head	bar	0.15								
	Secondary pressure loss	bar			0.13	0.25	0.33	0.44	0.57		
	Proposal for buffer tank type ^{1,2}	Type	PS500								
	Proposal for primary energy output ^{1,2}	kW			11	14	18	21	24		
	Max. mixed water temperature (10-38°C) ³	Litres			19	27	34	40	46		

Caution: Designs are based on individual stations. In the case of cascading, a corresponding calculation must be made.

¹⁾ The proposed boiler output and buffer tank size and type are based on a design with fixed parameters.

This is therefore a sample calculation and it is your responsibility to check all the parameters!

²⁾ In the design, the availability of primary energy sources (e.g. boilers, etc.) must be taken into account accordingly and only calculated on the demand for hot water preparation (other consumers must be taken into account separately accordingly).

³⁾ Max. draw-off volume (limited)



Performance data

Basic criteria for design/calculation:

Cold water temperature:	°C	10
Critical draw-off duration:	Min.	10
Heat source activation time:	Min.	3
Buffer tank recharging time:	Min.	30
Cycle time:	Min.	40
Free boiler output (100% priority switching):	%	100

All of the specifications are intended to facilitate the design process and must be checked before implementation.

LogoFresh M-Line electronic – performance table											
Domestic water heating Around 35K (10-45°C)	Flow line temperature primary	°C	50	55	60	65	70	75	80	85	
	Return line temperature primary	°C	27	24	22	21	20	19	18	18	
	Domestic hot water draw-off volume	l/min	20	27	33	38	43	48	53	58	
	Domestic hot water output	kW	48	65	80	93	105	117	129	140	
	Primary flow rate	l/h	1862								
	Primary pressure loss	bar	0.33								
	Primary residual delivery head	bar	0.15								
	Secondary pressure loss	bar	0.18	0.33	0.50	0.68	0.88	1.10	1.33	1.59	
	Proposal for buffer tank type ^{1,2}	Type	PS500								
	Proposal for primary energy output ^{1,2}	kW	13	18	22	25	28	32	35	38	
	Max. mixed water temperature (10-38°C) ³	Litres	25	33	41	48	54	60	66	72	
	Domestic water heating Around 40K (10-50°C)	Flow line temperature primary	°C		55	60	65	70	75	80	85
Return line temperature primary		°C		30	27	24	23	22	21	20	
Domestic hot water draw-off volume		l/min		19	25	31	36	40	45	49	
Domestic hot water output		kW		53	71	86	99	112	125	136	
Primary flow rate		l/h	1862								
Primary pressure loss		bar	0.33								
Primary residual delivery head		bar	0.15								
Secondary pressure loss		bar		0.16	0.30	0.44	0.60	0.76	0.94	1.14	
Proposal for buffer tank type ^{1,2}		Type	PS500								
Proposal for primary energy output ^{1,2}		kW		14	19	23	27	30	35	37	
Max. mixed water temperature (10-38°C) ³		Litres		27	36	44	51	58	64	70	
Domestic water heating Around 50K (10-60°C)		Flow line temperature primary	°C				65	70	75	80	85
	Return line temperature primary	°C				35	31	28	26	25	
	Domestic hot water draw-off volume	l/min				18	24	28	32	36	
	Domestic hot water output	kW				63	82	98	112	126	
	Primary flow rate	l/h	1862								
	Primary pressure loss	bar	0.33								
	Primary residual delivery head	bar	0.15								
	Secondary pressure loss	bar				0.15	0.26	0.37	0.49	0.62	
	Proposal for buffer tank type ^{1,2}	Type	PS500								
	Proposal for primary energy output ^{1,2}	kW				17	23	26	30	35	
	Max. mixed water temperature (10-38°C) ³	Litres				32	42	50	58	65	

Caution: Designs are based on individual stations. In the case of cascading, a corresponding calculation must be made.

¹⁾ The proposed boiler output and buffer tank size and type are based on a design with fixed parameters.

This is therefore a sample calculation and it is your responsibility to check all the parameters!

²⁾ In the design, the availability of primary energy sources (e.g. boilers, etc.) must be taken into account accordingly and only calculated on the demand for hot water preparation (other consumers must be taken into account separately accordingly).

³⁾ Max. draw-off volume (limited)



LogoFresh electronic L-Line

Performance data

Basic criteria for design/calculation:

Cold water temperature:	°C	10
Critical draw-off duration:	Min.	10
Heat source activation time:	Min.	3
Buffer tank recharging time:	Min.	30
Cycle time:	Min.	40
Free boiler output (100% priority switching):	%	100

All of the specifications are intended to facilitate the design process and must be checked before implementation.

LogoFresh L-Line electronic – performance table											
Domestic water heating Around 35K (10-45°C)	Flow line temperature primary	°C	50	55	60	65	70	75	80	85	
	Return line temperature primary	°C	24	21	19	18	17	16	15	14	
	Domestic hot water draw-off volume	l/min	38	51	61	70	80	80	80	80	
	Domestic hot water output	kW	94	123	148	171	193	193	193	193	
	Primary flow rate	l/h	3240	3240	3240	3240	3240	2841	2578	2365	
	Primary pressure loss	bar	0.35	0.35	0.35	0.35	0.35	0.27	0.22	0.19	
	Primary residual delivery head	bar	0.2	0.2	0.2	0.2	0.2	0.32	0.40	0.46	
	Secondary pressure loss	bar	0.26	0.43	0.61	0.80	1.03	1.03	1.03	1.03	
	Proposal for buffer tank type ^{1,2}	Type	PS850								
	Proposal for primary energy output ^{1,2}	kW	25	35	45	50	55	55	55	55	
	Max. mixed water temperature (10-38°C) ³	Litres	48	63	76	88	100	100	100	100	

Domestic water heating Around 40K (10-50°C)	Flow line temperature primary	°C		55	60	65	70	75	80	85	
	Return line temperature primary	°C		27	23	21	20	18	17	16	
	Domestic hot water draw-off volume	l/min		37	48	58	66	74	80	80	
	Domestic hot water output	kW		103	134	161	184	207	223	223	
	Primary flow rate	l/h		3240	3240	3240	3240	3240	3066	2788	
	Primary pressure loss	bar		0.35	0.35	0.35	0.35	0.35	0.31	0.26	
	Primary residual delivery head	bar		0.2	0.2	0.2	0.2	0.2	0.25	0.34	
	Secondary pressure loss	bar		0.25	0.40	0.55	0.72	0.89	1.03	1.03	
	Proposal for buffer tank type ^{1,2}	Type	PS850								
	Proposal for primary energy output ^{1,2}	kW		30	40	45	50	55	60	60	
	Max. mixed water temperature (10-38°C) ³	Litres		53	69	82	95	106	114	114	

Domestic water heating Around 50K (10-60°C)	Flow line temperature primary	°C				65	70	75	80	85
	Return line temperature primary	°C				31	27	24	23	21
	Domestic hot water draw-off volume	l/min				35	45	53	60	67
	Domestic hot water output	kW				123	157	185	210	234
	Primary flow rate	l/h				3240				
	Primary pressure loss	bar				0.35				
	Primary residual delivery head	bar				0.2				
	Secondary pressure loss	bar				0.22	0.35	0.47	0.60	0.74
	Proposal for buffer tank type ^{1,2}	Type				PS750				
	Proposal for primary energy output ^{1,2}	kW				35	45	50	60	65
	Max. mixed water temperature (10-38°C) ³	Litres				63	80	95	108	120

Caution: Designs are based on individual stations. In the case of cascading, a corresponding calculation must be made.

¹⁾ The proposed boiler output and buffer tank size and type are based on a design with fixed parameters.

This is therefore a sample calculation and it is your responsibility to check all the parameters!

²⁾ In the design, the availability of primary energy sources (e.g. boilers, etc.) must be taken into account accordingly and only calculated on the demand for hot water preparation (other consumers must be taken into account separately accordingly).

³⁾ Max. draw-off volume (limited)

LogoFresh electronic XL-Line



Performance data

Basic criteria for design/calculation:

Cold water temperature:	°C	10
Critical draw-off duration:	Min.	10
Heat source activation time:	Min.	3
Buffer tank recharging time:	Min.	30
Cycle time:	Min.	40
Free boiler output (100% priority switching):	%	100

All of the specifications are intended to facilitate the design process and must be checked before implementation.

LogoFresh XL-Line 100 electronic – performance table											
Domestic water heating Around 40K (10-50°C)	Flow line temperature primary	°C		55	60	65	70	75	80	85	
	Return line temperature primary	°C		30	26	24	21	19	18	17	
	Domestic hot water draw-off volume	l/min		68	91	100	100	100	100	100	
	Domestic hot water output	kW		190	252	278	278	278	278	278	
	Primary flow rate	l/h		6600	6600	5890	4982	4375	4075	3780	
	Primary pressure loss	bar		0.61	0.61	0.5	0.36	0.28	0.26	0.26	
	Primary residual delivery head	bar		0.3	0.3	0.51	0.75	0.86	0.9	0.9	
	Secondary pressure loss	bar		0.25	0.39	0.46	0.46	0.46	0.46	0.46	
	Proposal for buffer tank type ^{1,2}	Type		PS1500			PS1200		PS1000		
	Proposal for primary energy output ^{1,2}	kW		51	70	75	75	75	75	75	75
Max. mixed water temperature (10-38°C) ³	Litres		97	130	143	143	143	143	143	143	
Domestic water heating Around 50K (10-60°C)	Flow line temperature primary	°C				65	70	75	80	85	
	Return line temperature primary	°C				35	31	28	25	23	
	Domestic hot water draw-off volume	l/min				64	84	100	100	100	
	Domestic hot water output	kW				224	291	346	346	346	
	Primary flow rate	l/h				6600	6600	6560	5590	4932	
	Primary pressure loss	bar				0.61	0.61	0.6	0.45	0.33	
	Primary residual delivery head	bar				0.3	0.3	0.3	0.6	0.78	
	Secondary pressure loss	bar				0.21	0.34	0.46	0.46	0.46	
	Proposal for buffer tank type ^{1,2}	Type				PS1500			PS1000		
	Proposal for primary energy output ^{1,2}	kW				60	80	95	95	95	
Max. mixed water temperature (10-38°C) ³	Litres				114	150	179	179	179		
LogoFresh XL-Line 120 electronic – performance table											
Domestic water heating Around 40K (10-50°C)	Flow line temperature primary	°C		55	60	65	70	75	80	85	
	Return line temperature primary	°C		27	24	22	19	17	16	15	
	Domestic hot water draw-off volume	l/min		83	110	125	125	125	125	125	
	Domestic hot water output	kW		231	303	346	346	346	346	346	
	Primary flow rate	l/h		7400	7400	7050	6013	5320	4760	4450	
	Primary pressure loss	bar		0.6	0.6	0.51	0.39	0.32	0.3	0.3	
	Primary residual delivery head	bar		0.21	0.21	0.3	0.62	0.76	0.8	0.8	
	Secondary pressure loss	bar		0.26	0.43	0.55	0.55	0.55	0.55	0.55	
	Proposal for buffer tank type ^{1,2}	Type		PS1500			PS1200		PS1000		
	Proposal for primary energy output ^{1,2}	kW		65	85	95	145	145	145	145	
Max. mixed water temperature (10-38°C) ³	Litres		119	157	179	179	179	179	179		
Domestic water heating Around 50K (10-60°C)	Flow line temperature primary	°C				65	70	75	80	85	
	Return line temperature primary	°C				32	28	26	23	20	
	Domestic hot water draw-off volume	l/min				79	101	120	125	125	
	Domestic hot water output	kW				273	350	415	432	432	
	Primary flow rate	l/h				7400	7400	7400	6710	5970	
	Primary pressure loss	bar				0.6	0.6	0.6	0.48	0.38	
	Primary residual delivery head	bar				0.21	0.21	0.21	0.44	0.64	
	Secondary pressure loss	bar				0.24	0.36	0.5	0.55	0.55	
	Proposal for buffer tank type ^{1,2}	Type				PS1500					
	Proposal for primary energy output ^{1,2}	kW				80	100	120	130	130	
Max. mixed water temperature (10-38°C) ³	Litres				141	180	214	223	223		

Caution: Designs are based on individual stations. In the case of cascading, a corresponding calculation must be made.

- The proposed boiler output and buffer tank size and type are based on a design with fixed parameters.
This is therefore a sample calculation and it is your responsibility to check all the parameters!
- In the design, the availability of primary energy sources (e.g. boilers, etc.) must be taken into account accordingly and only calculated on the demand for hot water preparation (other consumers must be taken into account separately accordingly).
- Max. draw-off volume (limited)



LogoFresh thermostatic

Output ranges according to HW temperature

LogoFresh thermostatic performance diagram for 45°C hot water temperature

- S-Line
- M-Line

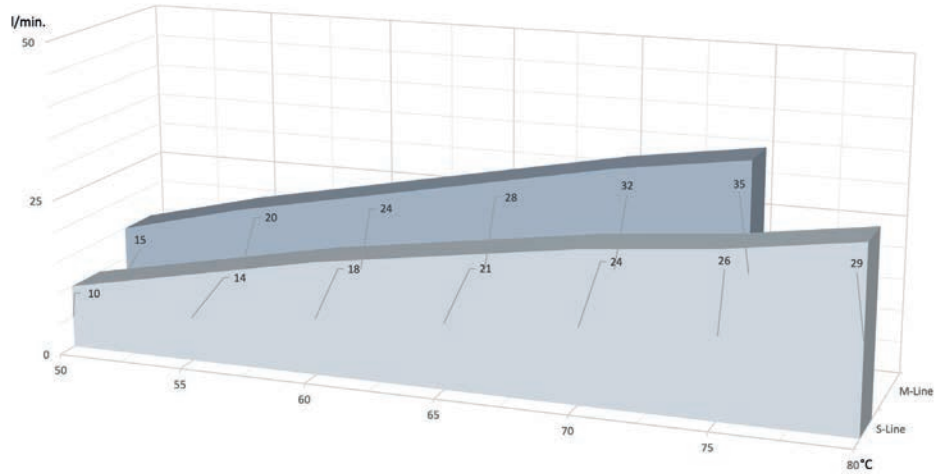

LogoFresh thermostatic performance diagram for 50°C hot water temperature

- S-Line
- M-Line

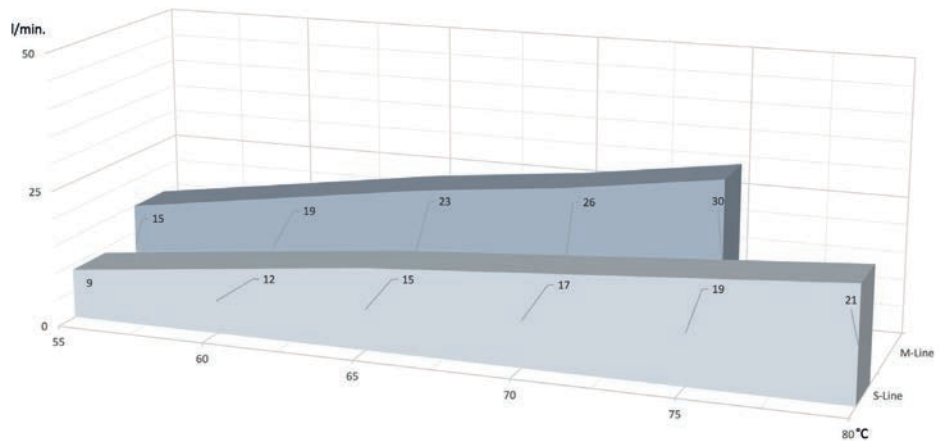

LogoFresh thermostatic performance diagram for 60°C hot water temperature

- S-Line
- M-Line

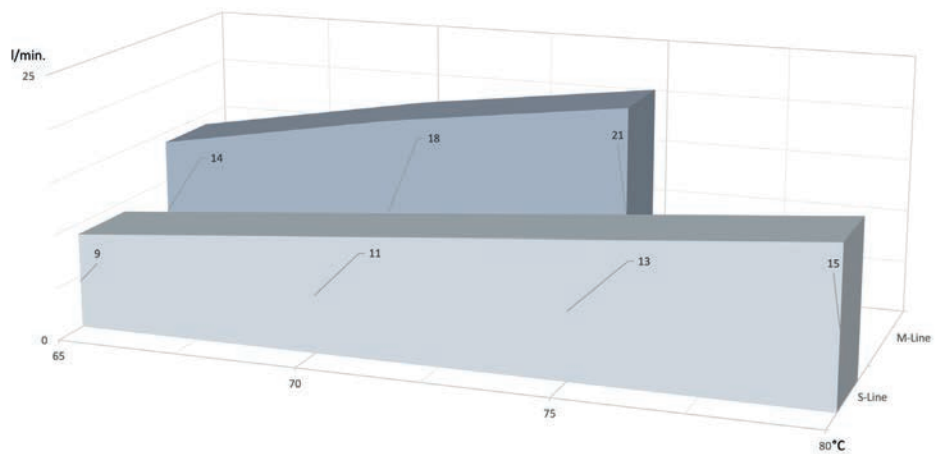

LogoFresh thermostatic

Connection types

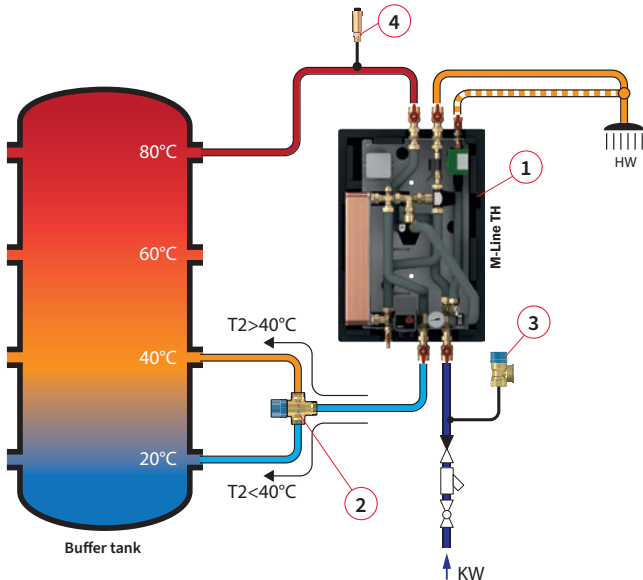

Integration example using single system as an example LogoFresh M-Line thermostatic

Designations:

1. LogoFresh M-Line with domestic hot water circulation
2. Return line stratified module (thermostatically controlled) FLAMCOMIX HC 20-70°C
3. Safety valve Prescor 1/2", 6 bar
4. Automatic air vent

Remarks:

- 1) To use the return line stratified module (no. 2): When, for example, a small volume of hot water is being drawn off or during operation of the LogoFresh with corresponding flow temperatures, the return line temperature may be higher. In this case, it is recommended for the return line heating water to be fed into a different temperature zone in the buffer tank to prevent mixing and thus increase efficiency.
- 2) On the domestic water side, the corresponding safety devices according to DIN must be provided upstream of the LogoFresh.

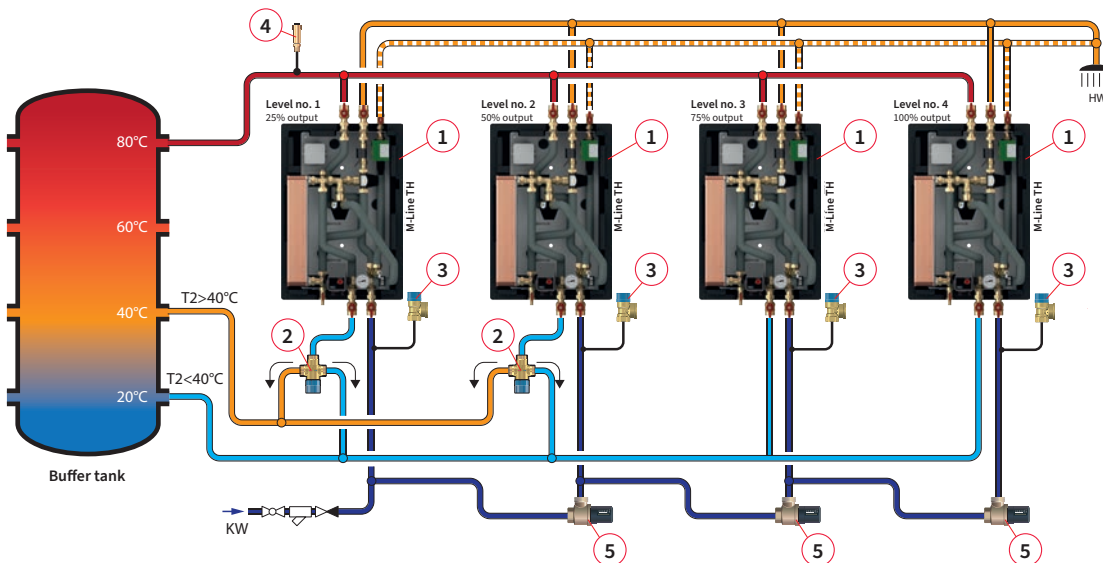

Integration example for parallel connection using the LogoFresh M-Line thermostatic as an example

Designations:

1. LogoFresh M-Line with domestic hot water circulation
2. Return line stratified module (thermostatically controlled) FLAMCOMIX HC 20-70°C
3. Safety valve Prescor 1/2", 6 bar
4. Automatic air vent
5. Overflow valve DN25, with setting range 0-500 mbar

Remarks:

- 1) When thermostatically controlling LogoFresh are connected in parallel, up to four LogoFresh of the same type can be combined.
- 2) Regarding the integration example: In most overall systems, 90% of the time the overall system is operated at an output level between 30-50% of the maximum achievable output. Here it is a good idea to use the return line stratified modules (no. 2) only for the first LogoFresh. The following LogoFresh only cover the short-term peak demand for water draw-offs and any resulting savings due to their stratification are negligible.
- 3) Overflow valves (no. 5) are installed on the cold water supply side (starting with the second LogoFresh). They regulate the cold water supply by means of the pressure difference.
- 4) A safety device must be installed upstream of each of the LogoFresh.



LogoFresh thermostatic S-Line

Technical data

Compact, ready-to-fit central fresh water stations with thermostatically controlled hot water preparation for wall mounting.

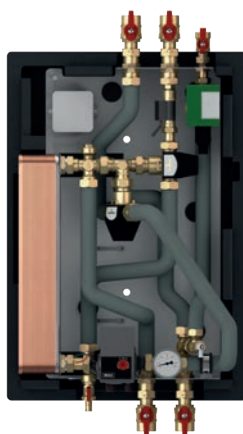

Fig.1

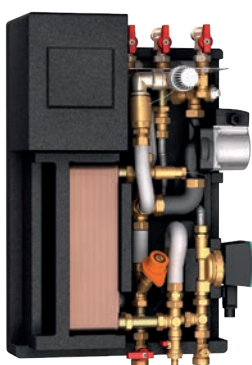

Fig. 2

Equipment features and technical data of LogoFresh thermostatic S-Line & M-Line	M-Line		S-Line	
	Type 1	Type 2	Type 3	Type 4
Dimensions incl. housing (W×H×D in mm)	500×890 ¹⁾ ×340		460× 660 ¹⁾ × 250	
Max. pressure:	heating/sanitary		3 bar/6 bar	
Max. permissible temperatures:	heating/sanitary		110°C	
Supply voltage	230V/50Hz			
Bottom connections	1"	1" (3/4")	3/4"	
Wall mounting	✓			
Stainless-steel plate heat exchanger (copper-soldered), vertical design to reduce the risk of calcification	✓			
Achieves lower return line temperatures	✓			
Heating side high-efficiency recirculation pump	✓			
Bleed valve on the heating side	✓			
Backflow preventer	-	-	✓	
Shut-off valves (except for cold water inlet)	✓			
Pipework from insulated stainless-steel corrugated tubing	✓			
Mounted entirely mechanically tension-free on base plate, inserted in housing and inspected	✓			
Domestic water circulation with pump, backflow preventer, piping and screw fitting components installed in the station	-	✓	-	✓
Flow switch	✓			
Connection option for temperature sensor connector	✓	-	-	
Mixing of primary return line water for red. FL temperature	✓			
Continuously adjustable heating medium flow rate via therm. domestic water regulator	✓			
Scalding protection	✓	-		
Temperature adjusting range on heating side (flow line temperature limitation measured in heating medium)	50–75°C		-	
Temperature adjustment range of hot water (measured in hot water)	45–65°C		20–65°C	
Temperature display on device (heating side)	✓	-		
Housing:	Full EPP insulation of housing (black)		✓	
Terminal box for electric connection	✓			
Number of possible parallel connections (overflow valve required)	4			
Insulation wedges for tank installation – connectible wedges for pre-formed rear-wall insulation for mounting directly onto a tank (tank ø ≥ 600 mm)	-		Optional	

Model	Fig.	Art. no.
Type 1 – LogoFresh M-line thermostatic		M10271.41
Type 2 – LogoFresh M-line thermostatic with DWC	Fig. 1	M10271.4
Type 3 – LogoFresh S-line thermostatic		M10271.51
Type 4 – LogoFresh S-line thermostatic with DWC	Fig. 2	M10271.5
Type 3 & Type 4 – insulation wedge for tank installation		M66306.3673

¹⁾ Incl. shut off ball valves

LogoFresh thermostatic S-Line



Performance data

Basic criteria for design/calculation:

Cold water temperature:	°C	10
Critical draw-off duration:	Min.	10
Heat source activation time:	Min.	3
Buffer tank recharging time:	Min.	30
Cycle time:	Min.	40
Free boiler output (100% priority switching):	%	100

All of the specifications are intended to facilitate the design process and must be checked before implementation.

LogoFresh S-Line thermostatic - performance table														
Domestic water heating Around 35K (10-45°C)	Flow line temperature primary	°C	50	55	60	65	70	75	80					
	Return line temperature primary	°C	29	26	24	23	22	21	20					
	Domestic hot water draw-off volume	l/min	10	14	18	21	24	26	29					
	Domestic hot water output	kW	25	35	43	50	57	64	71					
	Primary flow rate	l/h	1050											
	Primary pressure loss	bar	0.28											
	Primary residual delivery head	bar	0.15											
	Secondary pressure loss	bar	0.11	0.21	0.34	0.46	0.6	0.7	0.87					
	Proposal for buffer tank type ^{1,2}	Type	PS500											
	Proposal for primary energy output ^{1,2}	kW	8	10	12	15	16	17	19					
Max. mixed water temperature (10-38°C) ³	Litres	13	18	23	26	30	33	36						
Domestic water heating Around 40K (10-50°C)	Flow line temperature primary	°C	55							60	65	70	75	80
	Return line temperature primary	°C	29							26	23	21	20	19
	Domestic hot water draw-off volume	l/min	9							12	15	17	19	21
	Domestic hot water output	kW	25							35	42	46	52	58
	Primary flow rate	l/h	1050											
	Primary pressure loss	bar	0.28											
	Primary residual delivery head	bar	0.15											
	Secondary pressure loss	bar	0.11	0.18	0.27	0.38	0.5	0.65						
	Proposal for buffer tank type ^{1,2}	Type	PS500											
	Proposal for primary energy output ^{1,2}	kW	7		10	12	13	14	16					
Max. mixed water temperature (10-38°C) ³	Litres	13		17	21	24	27	30						
Domestic water heating Around 50K (10-60°C)	Flow line temperature primary	°C	65							70	75	80		
	Return line temperature primary	°C	34							29	27	25		
	Domestic hot water draw-off volume	l/min	9							11	13	15		
	Domestic hot water output	kW	30							39	46	52		
	Primary flow rate	l/h	1050											
	Primary pressure loss	bar	0.28											
	Primary residual delivery head	bar	0.15											
	Secondary pressure loss	bar	0.11	0.15	0.24	0.3								
	Proposal for buffer tank type ^{1,2}	Type	PS500											
	Proposal for primary energy output ^{1,2}	kW	10		11	12	14							
Max. mixed water temperature (10-38°C) ³	Litres	16		20	23	27								

Caution: Designs are based on individual stations. In the case of cascading, a corresponding calculation must be made.

¹⁾ The proposed boiler output and buffer tank size and type are based on a design with fixed parameters.

This is therefore a sample calculation and it is your responsibility to check all the parameters!

²⁾ In the design, the availability of primary energy sources (e.g. boilers, etc.) must be taken into account accordingly and only calculated on the demand for hot water preparation (other consumers must be taken into account separately accordingly).

³⁾ Max. draw-off volume (limited)



LogoFresh thermostatic M-Line

Performance data

Basic criteria for design/calculation:

Cold water temperature:	°C	10
Critical draw-off duration:	Min.	10
Heat source activation time:	Min.	3
Buffer tank recharging time:	Min.	30
Cycle time:	Min.	40
Free boiler output (100% priority switching):	%	100

All of the specifications are intended to facilitate the design process and must be checked before implementation.

LogoFresh M-Line thermostatic – performance table								
Domestic water heating Around 35K (10-45°C)	Flow line temperature primary	°C	50	55	60	65	70	75
	Return line temperature primary	°C	26	22	20	19	18	17
	Domestic hot water draw-off volume	l/min	15	20	24	28	32	35
	Domestic hot water output	kW	37	49	59	69	77	86
	Primary flow rate	l/h	1310					
	Primary pressure loss		0.36					
	Primary residual delivery head		0.15					
	Secondary pressure loss	bar	0.13	0.23	0.35	0.46	0.58	0.71
	Proposal for buffer tank type ^{1,2}	Type	PS500					
	Proposal for primary energy output ^{1,2}	kW	10	13	16	19	21	23
	Max. mixed water temperature (10-38°C) ³	Litres	19	25	30	35	40	44

Domestic water heating Around 40K (10-50°C)	Flow line temperature primary	°C		55	60	65	70	75
	Return line temperature primary	°C		28	24	22	21	19
	Domestic hot water draw-off volume	l/min		15	19	23	26	30
	Domestic hot water output	kW		41	53	64	72	83
	Primary flow rate	l/h	1310					
	Primary pressure loss	bar	0.36					
	Primary residual delivery head	bar	0.15					
	Secondary pressure loss	bar		0.13	0.21	0.31	0.39	0.52
	Proposal for buffer tank type ^{1,2}	Type	PS500					
	Proposal for primary energy output ^{1,2}	kW		12	14	17	20	23
	Max. mixed water temperature (10-38°C) ³	Litres		21	27	33	37	43

Domestic water heating Around 50K (10-60°C)	Flow line temperature primary	°C			65	70	75	
	Return line temperature primary	°C			33	28	26	
	Domestic hot water draw-off volume	l/min			14	18	21	
	Domestic hot water output	kW			48	62	73	
	Primary flow rate	l/h	1310					
	Primary pressure loss	bar	0.36					
	Primary residual delivery head	bar	0.15					
	Secondary pressure loss	bar			0.12	0.19	0.26	
	Proposal for buffer tank type ^{1,2}	Type	PS500					
	Proposal for primary energy output ^{1,2}	kW			13	17	20	
	Max. mixed water temperature (10-38°C) ³	Litres			25	32	38	

Caution: Designs are based on individual stations. In the case of cascading, a corresponding calculation must be made.

- ¹⁾ The proposed boiler output and buffer tank size and type are based on a design with fixed parameters.
This is therefore a sample calculation and it is your responsibility to check all the parameters!
- ²⁾ In the design, the availability of primary energy sources (e.g. boilers, etc.) must be taken into account accordingly and only calculated on the demand for hot water preparation (other consumers must be taken into account separately accordingly).
- ³⁾ Max. draw-off volume (limited)

Heating system components

Buffer tank PS500 to PS2000

Can be used in closed hot water heating systems. Robust and easy to install design. Equipped with various sensor connections for individual installation, for example of temperature sensors at different tank heights. Foot height adjustment (up to 2000 l) for fast and safe alignment. Exterior powder coating, interior untreated.

Reliable operating overpressure: 3 bar (6 bar on request)

Reliable operating temperature: 95°C

Thermal insulation (only for heating systems): 100 mm fleece insulation with a polystyrene top layer as an easy to install kit.

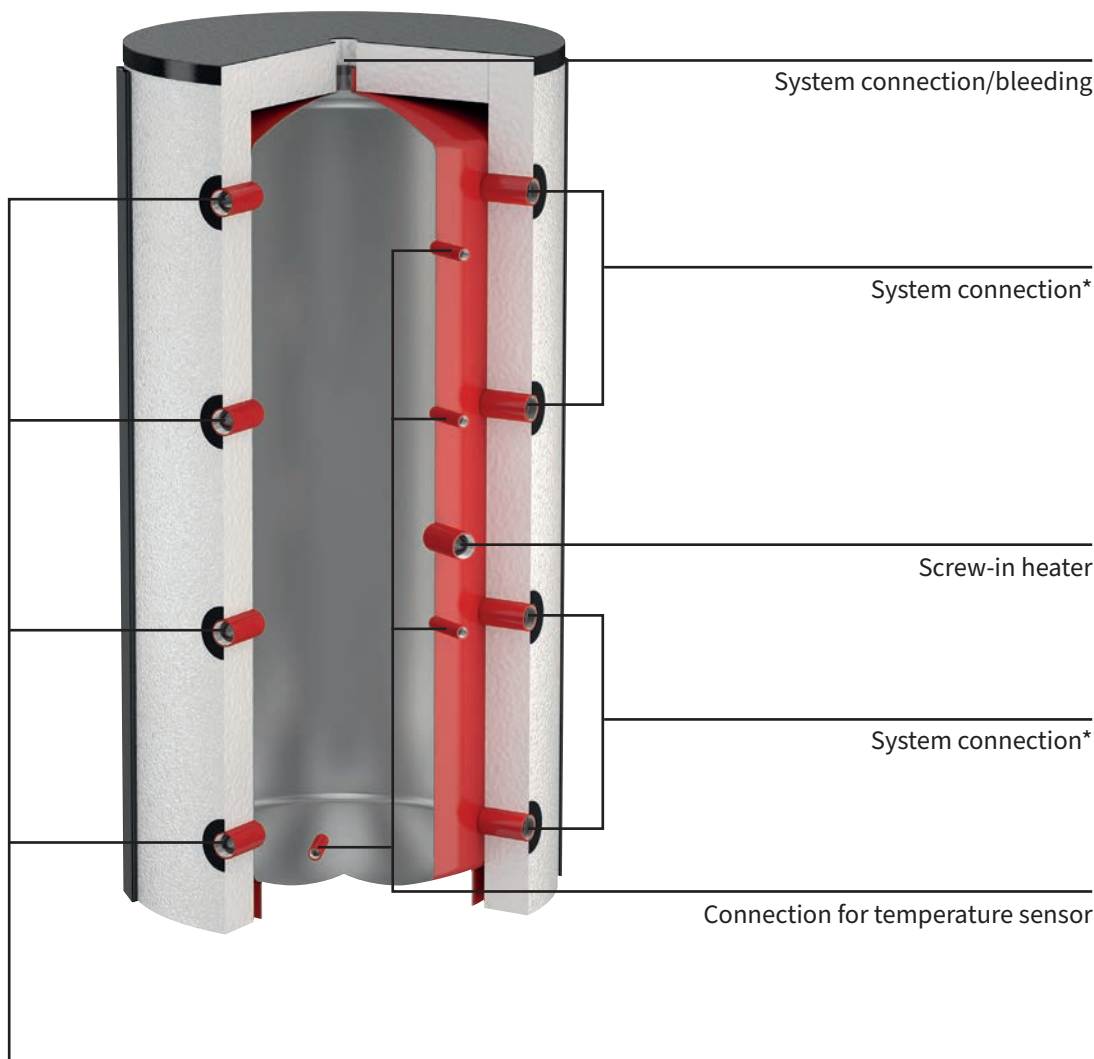

*) System connection:
Flow and return connections
according to individual
system configuration

Buffer tanks PS selected for their robust and low maintenance design. The tanks are manufactured by specialists at a modern German production site.

Heating system components

Buffer tank PS500 to PS2000

Buffer tank with solar coil available on request.

Type	Nominal capacity Litres [l]	Dimension*			Weight [kg]	Art. no. Speicher	Art. no. insulation RAL 9010 white (80 mm)
		Ø [mm]	H [mm]	Tilting height [mm] without insulation			
FlexTherm PS 500	500	650	1650	1700	80	18756	18681
FlexTherm PS 600	600	650	2050	2100	93	19380	18684
FlexTherm PS 750	750	790	1800	1850	102	18786	18687
FlexTherm PS 1000 (Ø790)	1000	790	2200	2250	170	18885	18693
FlexTherm PS 1000 (Ø850)	1000	850	2000	2050	172	18850	18696
FlexTherm PS 1200	1200	850	2250	2300	175	18843	18699
FlexTherm PS 1500	1500	1000	2320	2380	225	18816	18702
FlexTherm PS 1800	1800	1100	2200	2250	272	18856	18705
FlexTherm PS 2000	2000	1100	2350	2400	310	18826	18708

*Insulation – 100 mm depth

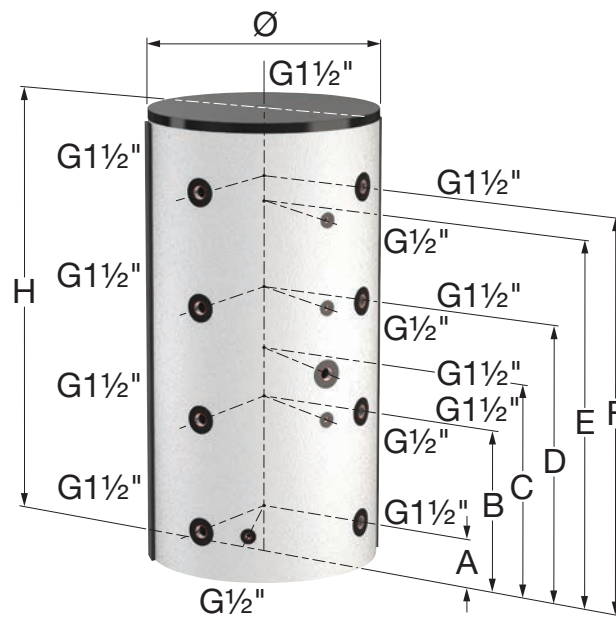

Type	Position of the connections (in mm)						Weight (without insulation) kg	Weight ISO kg
	A	B	C	D	E	F		
PS 500	180	600	770	1010	1330	1430	80	19.1
PS 600	180	730	980	1280	1730	1830	93	24.6
PS 750	270	690	940	1100	1420	1520	102	24.2
PS 1000 (Ø 790)	270	820	995	1370	1820	1920	170	27.7
PS 1000 (Ø 850)	305	790	1075	1220	1605	1705	172	27.6
PS 1200	305	855	1195	1405	1855	1955	175	31.9
PS 1500	340	890	1230	1440	1890	1990	225	36.8
PS 2000	350	900	1310	1450	1900	2000	310	39.3

Components for solar systems



Solar separation system – XL-Line

With two recirculation pumps (DN 15, installed length 130 mm) with connection cable; two flow rate limiters; stainless steel plate heat exchangers; two bleeding devices; a primary sensor seat; four shut-off ball valves; four flushing, filling and draining ball valves incl. hose nozzles and incl. safety groups for the primary and secondary sides; all installed and tested on a base plate; flexible stainless steel corrugated pipes with insulation. In EPP thermal insulation housing.

Model	Art. no.
For collector surfaces up to 14 m² (high-flow) or 31 m² (low-flow), with flow rate limiter 1–13 l/min. Primary with Grundfos UPM3 Hybrid 15–70 Secondary with Grundfos UPM3 Hybrid 5–70	M45140.16

For collector surfaces up to 32 m² (high-flow) or 71 m² (low-flow), with flow rate limiter 8–30 l/min. Primary with Grundfos UPM3 Hybrid 15–145 Secondary with Grundfos UPM3 Hybrid 15–70	M45140.19
--	-----------

We recommend solar controller ENERGY PRO or MAXIMAL PRO on page 26

As above but with integrated Energy Pro controller
(for more information on solar controllers, see page 33)

with flow rate limiter 1–13 l/min. Primary with Grundfos UPM3 Hybrid 15–70 Secondary with Grundfos UPM3 Hybrid 15–70	M45140.56
---	-----------

with flow rate limiter 8–30 l/min. Primary with Grundfos UPM3 Hybrid 15–145 Secondary with Grundfos UPM3 Hybrid 15–70	M45140.59
--	-----------





Solar separation system – XL-Line

Technical data		
Separation system type	M45140.16/56	M45140.19/59
Collector surface	Up to 31 m ²	Up to 71 m ²
Operating temperature	Up to 110°C, briefly 120°C (Observe the max. permissible temperature of the pump)	
Manometer indicated range	Primary: 0–10 bar (accessories) Secondary: 0–4 bar (accessories)	
Heat exchanger plate number	30	30
Max. output (primary 60/30°C, secondary 20/50°C, min. residual delivery head prim. 0.2 bar/sec. 0.1 bar)	18 kW (output with 31 m ² surface area at 65% efficiency ratio)	46 kW (output with 71 m ² surface area at 65% efficiency ratio)
Safety valve	Primary: 6 bar, Secondary: 3 bar	
Volumetric flow limiter	1–13 l/min: Art.-No. 45140.16/18/56/58 8–30 l/min: Art.-No. 45140.19/29/59/69	
Sealing material	PTFE (Teflon), asbestos-free fibre sealant, EPDM	
Components made of	Steel, brass, glass, EPP insulation	
Lower connection	1" female thread	
Expansion vessel connection	3/4" external thread (accessories)	
Axial distance	65 mm	
Dimensions (including cladding)	Approx. H 730 (1135) × W 500 (570) × D 350 mm	

Solar stations in similar design as above, however, with switching valves for 2 collector fields and/or 2 heat consumers available upon request.

Components for solar systems

Solar separation system – XXL-Line



Heat exchanger solar station, complete with two recirculation pumps, a stainless steel plate heat exchanger incl. block insulation, two volumetric flow limiters, two safety valves and manometers, four flushing, filling and draining ball valves, an air separator (secondary), a dirt trap (secondary), shut-off fittings with thermometer handles (on supply side, secondary with backflow preventer), installation frame made from aluminium profiles with height-adjustable feet.

Model	Art. no.
Volume flow limiter 10–40 l/min. Heat exchanger 30 plates	
Primary and secondary with Wilo Stratos 30/1–12	M45142.14
Volume flow limiter 10–40 l/min. Heat exchanger 30 plates	
Primary and secondary with Wilo Stratos Para 30/1–12	M45142.22



Technical data		
Separation system type	M45142.14	M45142.22
Collector surface	Up to 31 m ² (high-flow) Or 95 m ² (low-flow)	Up to 74 m ² (high-flow) Or 155 m ² (low-flow)
Max. output (primary 60/30°C, secondary 20/50°C, min. residual delivery head prim. 0.2 bar/sec. 0.1 bar)	62 kW (output with 95 m ² surface area at 65% efficiency ratio)	100 kW (output with 155 m ² surface area at 65% efficiency ratio)
Volumetric flow limiter	10–40 l/min	20–70 l/min
Operating temperature	Up to 110°C (Observe the max. permissible temperature of the pump)	
Safety valve	Primary: 10 bar Secondary: 3 bar	
Manometer indicated range	Primary: 0–10 bar Secondary: 0–4 bar	
Sealing material	PTFE (Teflon), asbestos-free fibre sealant, EPDM, FPM, silicone	
Components made of	Steel, brass, glass, PUR insulation WT	
Upper connection	1¼" female thread	
Lateral connection	1¼" female thread	
Axial distance	Top: 129 mm, lateral: 103 mm	
Dimensions (including cladding)	Approx. H 840 × W 950 × D 290 mm	

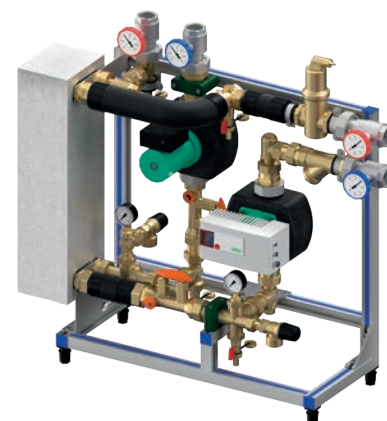

Other models available on request.
We recommend solar controller MAXIMAL PRO on page 33.

Please note the initial flow.



Solar controller

BASIC PRO

Digital differential temperature controller for thermal solar systems (1 collector field, 1 tank). Full graphic, backlit black/white display, operation via rotary/push control and ESC button, 3 inputs for PT 1000 sensor, analogue or PWM output for high-efficiency pump, speed regulation, pre-configured hydraulics diagram, 1 Triac output, error monitoring, manual operation option, collector safety function; commissioning/ service assistant, fixed T and Delta T regulation, tube collector function, shut-off delay for outputs, anti-freeze, sensor monitoring, monitoring of output parameters, operating hours counter, solar yield measurement for pump control also option without volumetric flow meter, delivery includes 2 PT 1000 universal temperature sensors



Model	Art. no.
Pump control by means of block modulation, PWM- or 0–10 V signal	M45111.56

ENERGY PRO

The same as the Basic Pro solar controller but with full graphic, dimmable colour display with background lighting, 2 Triac outputs, 1 potential-free output, 6 inputs for PT 1000 sensors, one of which is switchable as a control output and 2 additional fixed control outputs (0–10 V or PWM) for maximum three high-efficiency pumps, flow rate measurement function, SD card reader and USB connector (for software update, loading and saving controller settings, data logging), 24 pre-configured hydraulic systems, 2 collector fields and 2 tanks, solar heating system support, remote access, booster suppression, thermostat and temperature comparison function, solar priority charging, holiday function, anti-Legionella function, bypass and charging zone controller, scope of supply includes 2x PT 1000 universal temperature sensors and analysis software, control of secondary pump in separated systems, swimming pool heating systems



Pump control by means of block modulation, PWM- or 0–10 V signal	M45111.76
--	-----------

MAXIMAL PRO

As with the Energy Pro solar controller, however, with 4 Triac outputs, 1 potential-free output, 10 inputs for PT 1000 sensors, 4 of which are switchable for a maximum 4 high-efficiency pumps (0–10 V and PWM), radiation sensor, 30 pre-configured hydraulic diagrams, 2 collector fields and 2 tanks, circulation function, scope of supply includes 4 PT 1000 universal temperature sensors and analysis software



Pump control by means of block modulation, PWM- or 0–10 V signal	M45111.96
--	-----------

Smart Box V2 (for monitoring and remote access via Internet/intranet)

The Smart Box acts as an interface between the solar controller (Energy Pro or Maxima Pro) and the router. The solar system data can be visualised, analysed and parametrised from anywhere via LAN or WLAN. Ideal for presenting the temperatures and energy yields on a tablet in the living room or as a tool for external service companies or building control systems. The solar controller is operated easily and clearly via the Smart Box. USB, WLAN/Bluetooth, Ethernet or SD connections are available for the data transfer. This V2 (Version 2) is also characterised by its extremely low power consumption <1W.

M45111.002

Notes

Notes

Notes

We supply products

for the sanitary and heating industry to over 70 countries. Sales are handled by our subsidiaries and wholesalers, who know the local market and can provide you with expert advice at any time.

Germany

de.info@aalberts-hfc.com

Austria

at.info@aalberts-hfc.com

Switzerland

ch@info@aalberts-hfc.com

flamco.aalberts-hfc.com

