



**Flamco**

Your reliable partner

OPTIMAL PERFORMANCE THANKS TO DOUBLE THRUST FUNCTION

**Flamcovent Smart**  
**Flamco Clean Smart**  
**Flamcovent Clean Smart**



# groundbreaking innovation

Air bubbles and dirt particles are always present in the water of cooling and heating systems. The dirt can accumulate and cause blockages. The use of filters is not ideal because these do not trap smaller particles, silt up and then have to be regularly cleaned or replaced.

Air and gases in a system are generally a consequence of activities performed, micro-leaks and of electrolysis and chemical processes in the water. Traditional de-aeration devices extract insufficient gases from the water, leaving microbubbles behind.



**Flamcovent  
Clean Smart  
EcoPlus**



**Flamcovent  
Clean Smart**

Air and dirt in a system cause problems such as unnecessary faults and extra wear or noise, but also lead to disruption of the system, lower heat transfer and reduced pump performance. Consequence: higher energy consumption and an unreliable system. Something that nobody wants.

# new standard

## More compact, lighter, cleaner and more efficient

The new Flamco Smart, Flamco Clean Smart and Flamcovent Clean Smart air and dirt separators are smart products in every aspect. And just as in other innovations from Flamco, their groundbreaking new design also delivers optimal performance. These air and dirt separators for heating and cooling systems are the new standard.

## Flamco has the answer

The Smart air and dirt separators remove even the smallest microbubbles and minuscule dirt particles from the system water. They are near enough maintenance-free and the flow resistance is negligibly low. The magnetite particles present in the water are directly attracted by the magnetic field and all other dirt particles are also trapped extremely efficiently.

Flamco Clean Smart



Flamco  
Clean Smart  
EcoPlus

Flamcovent Smart



Flamcovent  
Smart  
EcoPlus

## Main advantages

- 60% better performance compared to conventional air and dirt separators.
- Suitable for temperatures of up to 120 °C.
- Suitable for operating pressures of up to maximum 10 bar.
- Unique flow velocities, up to 3 m/s.
- Can be used with all kinds of pipework.
- Compact dimensions, light weight.
- Available in various sizes up to 2".
- Extremely low flow resistance and low loss of energy.
- Consistent performance throughout its service life.

# Smart in every regard

## Double thrust function

Two thrust functions ensure efficient dirt removal and de-aeration of the system water. The first function is achieved by the action of the separating element built into the body in the path of the water flow through the unit. Contaminated water is diverted through the separating element. The second effect is achieved by combining the increased return flow of clean water from the plenum opposite the separation element back into the main stream. This forces the micro-bubbles and dirt particles towards the sides of the body and into the plenum chamber to be removed.

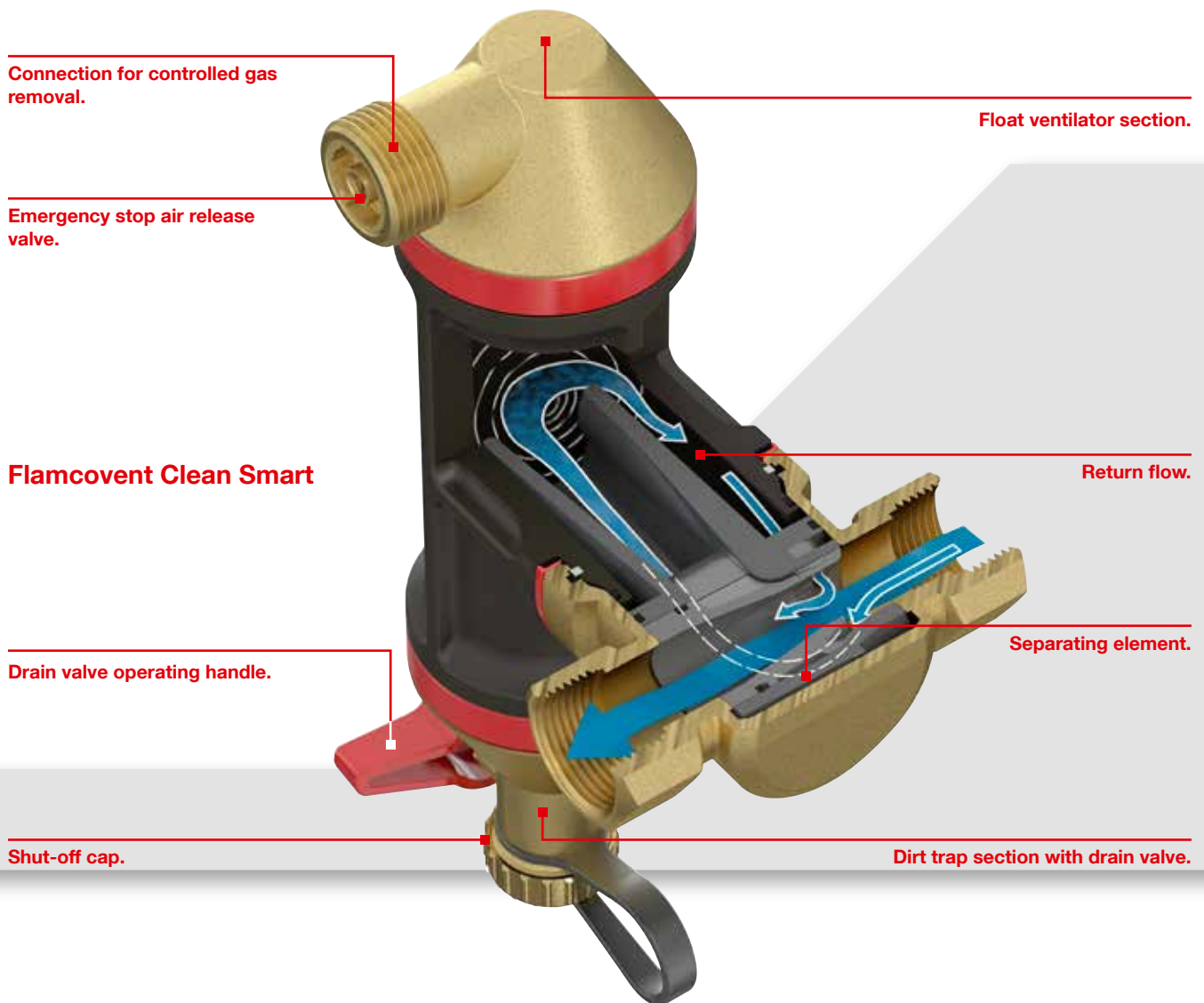

## Flamcovent Clean Smart

## Exceptional air and dirt removal performance

The separation element combined with the return flow ensure very efficient air & dirt separation. An exceptional rate of 40% of the air and dirt is separated per cycle while using only 10% isolation of the main flow.

Inside the enclosure of the separator the water velocity is heavily reduced which efficiently separates microbubbles and dirt particles. The air particles automatically rise to the air release valve device at the top. Particles are passed along bulkheads and trapped in the enclosure thanks to the low flow velocity.

A supermagnet additionally helps to trap ferrous particles. Flow resistance is negligible. Important advantages of this are the low energy consumption and the high removal performance for each passage of the water through the system.

# a smart concept

## Performs 60% better

Flamco Smart performs 60% better than conventional air and dirt separators, while the flow resistance has been reduced to a negligible level. This avoids wear to the pump of the central heating boiler and reduces energy costs.

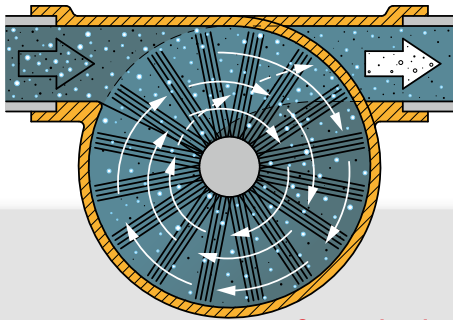

Conventional separator with complete throughflow: separation of at most 25% per cycle.

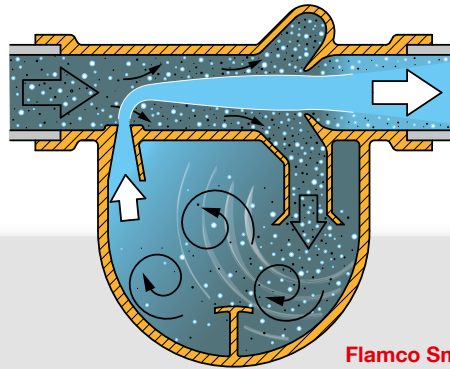

Flamco Smart: separation of 40% per cycle.

## Supermagnets

Four neodymium supermagnets are incorporated into the logo on the outside of the Flamco Clean Smart and the Flamcovent Clean Smart (fig. A). The magnetic rating per magnet is 5,855 Gauss. The logo/magnet holder is situated right opposite the outflow opening, through which all ferrous particles are directly attracted and held. Even particles as small as 4  $\mu\text{m}$  are removed.

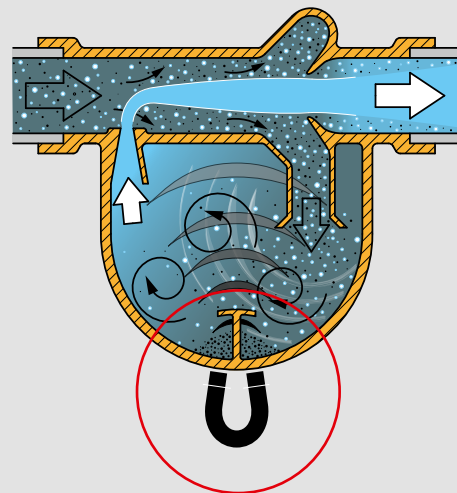

By pushing the logo/magnet holder downwards, the dirt particles are drawn to the underside of the dirt separator (fig. B) where they can be removed via the drain valve. Always keep the logo/magnet holder at a safe distance from pacemakers, electronic equipment and payment cards.



Fig. A



Fig. B

# optimal performance

## Efficient dirt separation

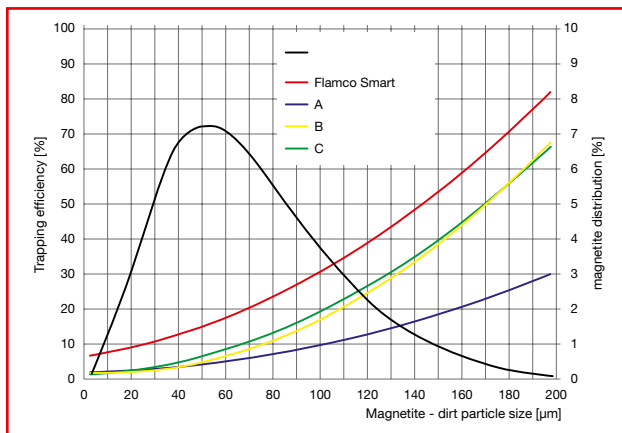

## Efficient air separation

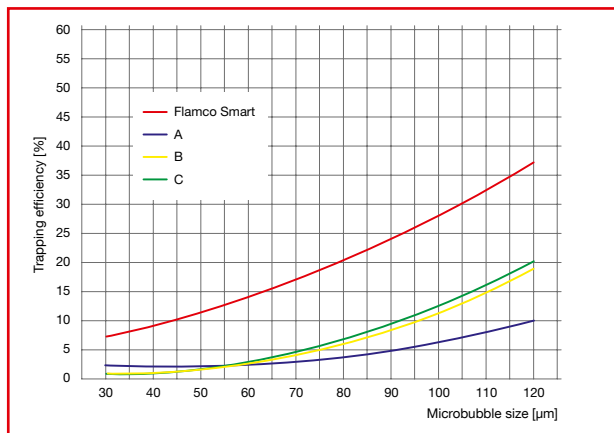

Measuring method verified by Deltares, measurement results based on silica particles.

## Selection table for Flamcovent & Clean Smart series

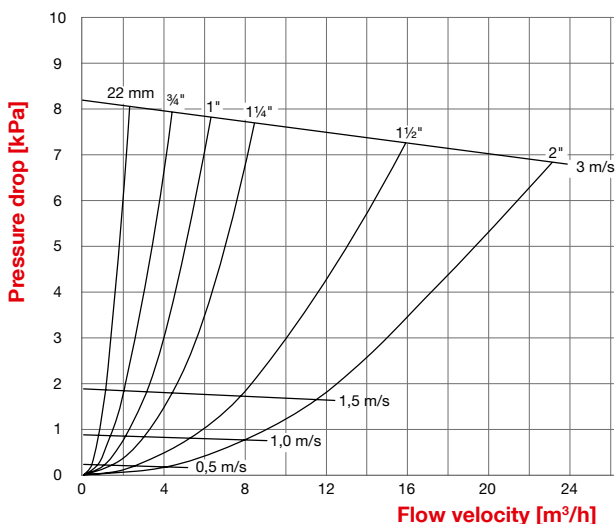

Thanks to the innovative design of this Smart series of air and dirt separators the pressure loss in the system is kept to a negligible minimum. Even at flow velocities of 3 m/s, the Smart series delivers the best performance on the market. The high efficiency of these devices ensure that cooling and heating systems provide optimum performance. The table is extremely easy to use for selecting the correct model.

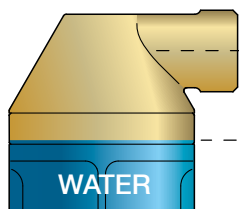

Flamco vent valve

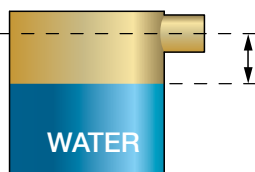

Regular vent valve

The air chamber of the Flamcovent is conical in shape. The advantage of this construction is that the distance between the water level and venting valve is larger than in a straight air chamber. This means that there is little chance of contamination.

Flamco Smart air and dirt separators are suitable for water and water/glycol mixtures of up to 50% glycol. They can be used with inhibitors that slow chemical reactions or with other approved chemical additives, subject to these meeting the guidelines contained in VDI 2035. Flamco Smart air and dirt separators are not suitable for potable water systems.

# practical



## Flexible assembly

An important feature of the latest generation of air and dirt separators is that they can be incorporated in a variety of heating and cooling systems. The compact dimensions of the Flamcovent Smart series enables them to be easily installed even when space is limited.

## Low-maintenance

The low-maintenance characteristic of the dirt separators is also a great advantage. The renewed technology ensures extended periods between necessary maintenance. A sticker can be affixed to the handle of the drain valve that makes it simple to show when maintenance was last performed.

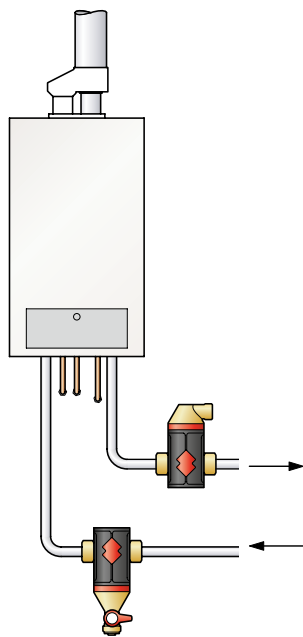

Fig. 4A

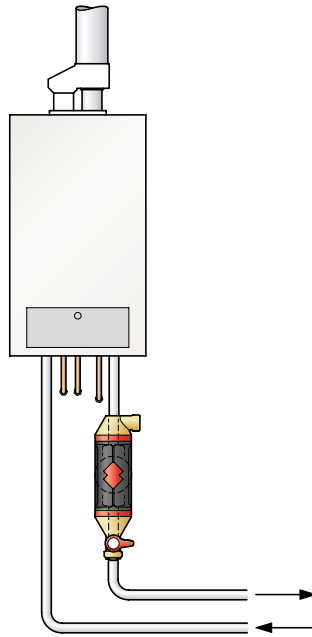

Fig. 4B

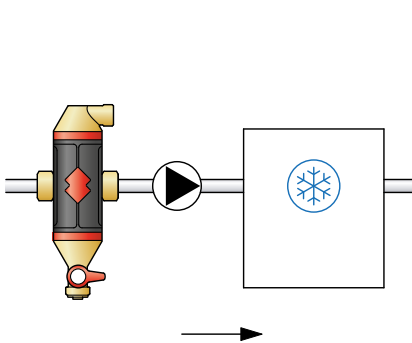

Fig. 4C

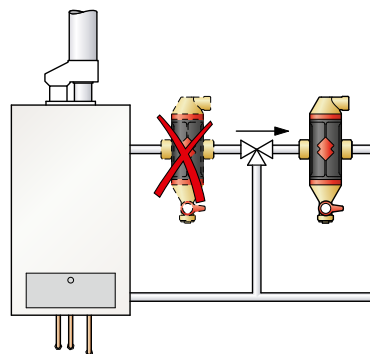

Fig. 4D

## Installation

Depending on the primary function (dirt or air separator), the air, dirt and combined air/dirt separators can be installed in a variety of ways (see fig. 4A, 4B, 4C, 4D). Place the product upstream of the boiler in the return line, if dirt separation is the primary function.

If the primary function is air separation or a combined air/dirt separator is being used, the optimum location is immediately downstream of the boiler or mixing valve, and upstream of the circulation pump. This traps bubbles produced immediately after heating the water.

In a cooling system that is just before the chiller.

The bleeding devices and dirt separators are manufactured with a  $\frac{3}{4}$ " connection to enable the connection of any drain line. Do not use these connections for filling the system.

# the complete series

## Wide product range

The new air and dirt separators from Flamco are supplied in six connection sizes: 22 mm, 3/4", 1", 1 1/4", 1 1/2" and 2". With or without an insulation jacket as required. The EPP insulation material has a thickness of 20 mm and an insulation value of ( $\lambda$ ) of 0.036 W/mK.

Thanks to the smart use of high-grade - and thus highly resistant - plastic in the body, these air and dirt separators represent a lower load for the heating system. This high-tech plastic is resistant to a pressure of 10 bar and a temperature of 120 °C. The de-aeration device and the drain section are made from brass.

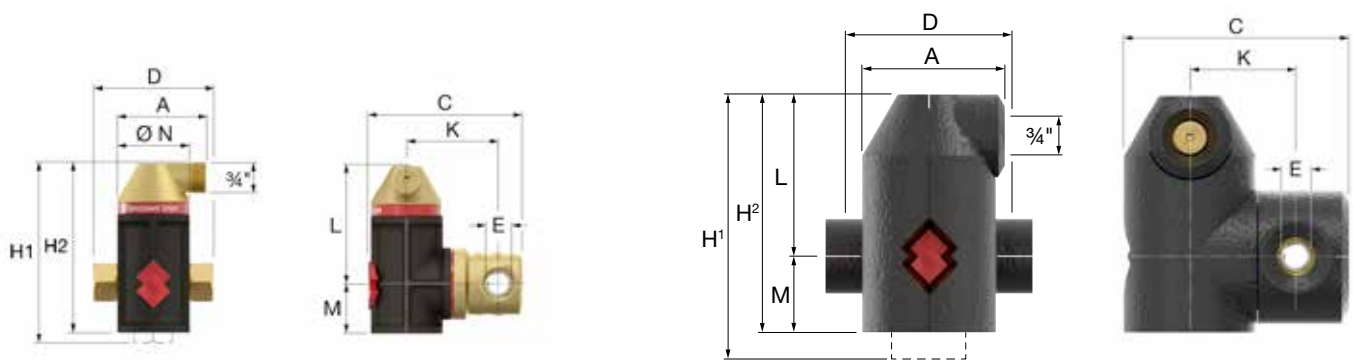

Flamcovent Smart

Flamcovent Smart EcoPlus

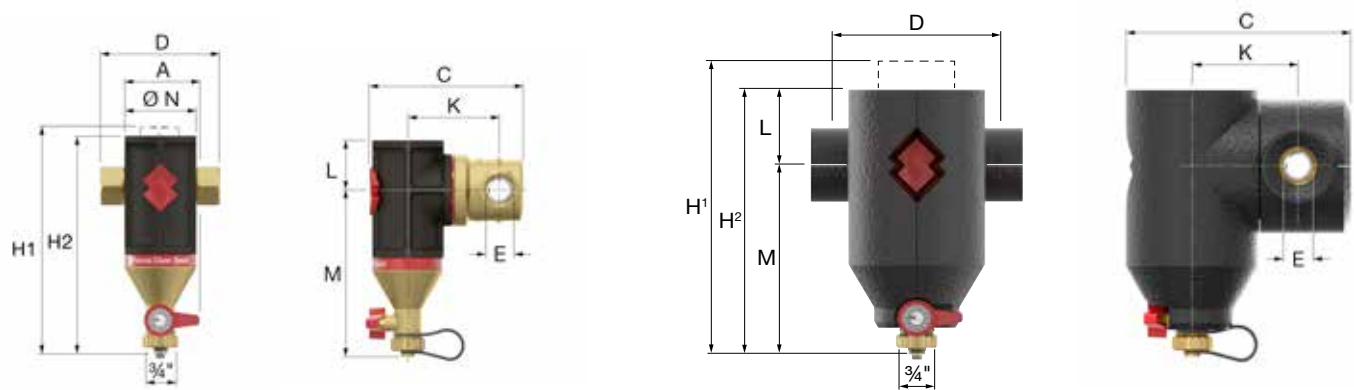

Flamco Clean Smart

Flamco Clean Smart EcoPlus

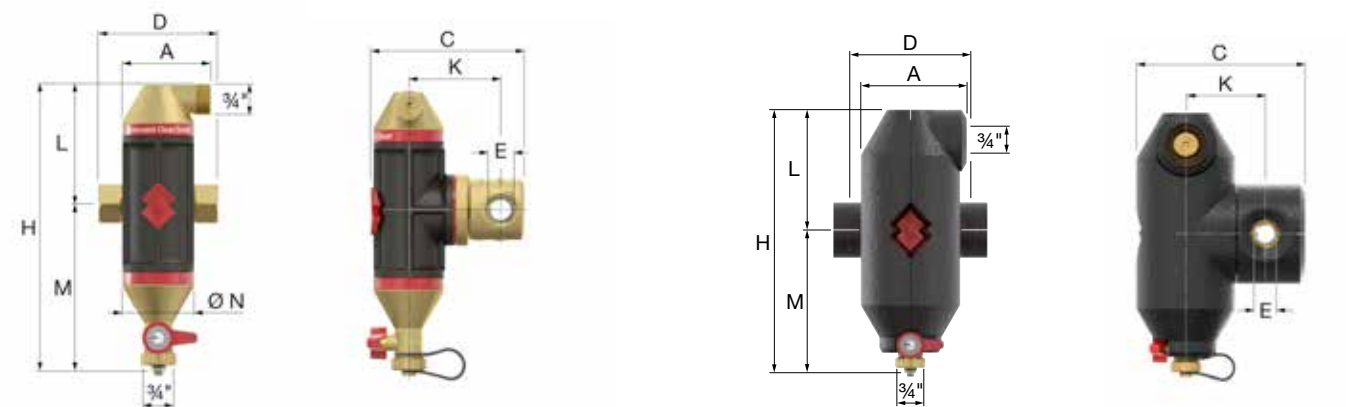



Flamcovent Clean Smart

Flamcovent Clean Smart EcoPlus





Flamcovent Smart														
Type	Weight [kg]	Connection E		Dimensions										Order Code
		["]	[mm]	A	C	D	K	L	M	H/H1	H2	Ø N		
Flamcovent Smart 3/4"	0.904	3/4	-	74	132	100	78	101	37	151	138	60	1	30001
Flamcovent Smart 22mm	0.948	-	22	74	134	120	78	101	37	161	138	60	1	30002
Flamcovent Smart 1"	1.118	1	-	82	155	106	91	139	45	192	184	75	1	30003
Flamcovent Smart 1 1/4"	1.271	1 1/4	-	82	165	110	96	139	45	194	184	75	1	30004
Flamcovent Smart 1 1/2"	1.732	1 1/2	-	94	193	129	109	173	54	238	227	92	1	30005
Flamcovent Smart 2"	2.162	2	-	94	206	140	117	173	54	243	227	92	1	30006

Flamco Clean Smart														
Type	Weight [kg]	Connection E		Dimensions										Order Code
		["]	[mm]	A	C	D	K	L	M	H/H1	H2	Ø N		
Flamco Clean Smart 3/4"	0.939	3/4	-	63	133	100	78	37	140	190	177	60	1	30021
Flamco Clean Smart 22mm	0.983	-	22	63	136	120	78	37	140	200	177	60	1	30022
Flamco Clean Smart 1"	1.109	1	-	76	155	106	91	44	179	231	223	75	1	30023
Flamco Clean Smart 1 1/4"	1.263	1 1/4	-	76	165	110	96	44	179	233	223	75	1	30024
Flamco Clean Smart 1 1/2"	1.724	1 1/2	-	94	193	129	109	54	212	277	266	92	1	30025
Flamco Clean Smart 2"	2.154	2	-	94	206	140	117	54	212	282	266	92	1	30026

Flamcovent Clean Smart														
Type	Weight [kg]	Connection E		Dimensions										Order Code
		["]	[mm]	A	C	D	K	L	M	H/H1	H2	Ø N		
Flamcovent Clean Smart 3/4"	1.198	3/4	-	74	133	100	78	101	140	241	-	60	1	30041
Flamcovent Clean Smart 22mm	1.242	-	22	74	136	120	78	101	140	241	-	60	1	30042
Flamcovent Clean Smart 1"	1.447	1	-	82	155	106	91	139	179	318	-	75	1	30043
Flamcovent Clean Smart 1 1/4"	1.600	1 1/4	-	82	165	110	96	139	179	318	-	75	1	30044
Flamcovent Clean Smart 1 1/2"	2.189	1 1/2	-	94	193	129	109	173	212	385	-	92	1	30045
Flamcovent Clean Smart 2"	2.619	2	-	94	206	140	117	173	212	385	-	92	1	30046

Flamcovent Smart EcoPlus														
Type	Weight [kg]	Connection E		Dimensions										Order Code
		["]	[mm]	A	C	D	K	L	M	H/H1	H2	Ø N		
Flamcovent Smart 3/4" EP	0.975	3/4	-	104	164	100	78	118	56	194	174	-	1	30011
Flamcovent Smart 22mm EP	1.019	-	22	104	164	120	78	118	56	194	174	-	1	30012
Flamcovent Smart 1" EP	1.225	1	-	117	189	106	91	157	63	233	220	-	1	30013
Flamcovent Smart 1 1/4" EP	1.382	1 1/4	-	117	199	110	96	157	63	233	220	-	1	30014
Flamcovent Smart 1 1/2" EP	1.890	1 1/2	-	134	224	129	109	191	72	279	263	-	1	30015
Flamcovent Smart 2" EP	2.327	2	-	134	237	140	117	191	72	279	263	-	1	30016

Flamco Clean Smart EcoPlus														
Type	Weight [kg]	Connection E		Dimensions										Order Code
		["]	[mm]	A	C	D	K	L	M	H/H1	H2	Ø N		
Flamco Clean Smart 3/4" EP	1.009	3/4	-	97	164	100	78	56	140	216	196	-	1	30031
Flamco Clean Smart 22mm EP	1.053	-	22	97	164	120	78	56	140	216	196	-	1	30032
Flamco Clean Smart 1" EP	1.214	1	-	112	189	106	91	63	178	255	241	-	1	30033
Flamco Clean Smart 1 1/4" EP	1.372	1 1/4	-	112	199	110	96	63	178	255	241	-	1	30034
Flamco Clean Smart 1 1/2" EP	1.879	1 1/2	-	131	224	129	109	73	212	300	285	-	1	30035
Flamco Clean Smart 2" EP	2.316	2	-	131	237	140	117	73	212	300	285	-	1	30036

Flamcovent Clean Smart EcoPlus														
Type	Weight [kg]	Connection E		Dimensions										Order Code
		["]	[mm]	A	C	D	K	L	M	H/H1	H2	Ø N		
Flamcovent Clean Smart 3/4" EP	1.281	3/4	-	104	164	100	78	118	140	258	-	-	1	30051
Flamcovent Clean Smart 22mm EP	1.325	-	22	104	164	120	78	118	140	258	-	-	1	30052
Flamcovent Clean Smart 1" EP	1.567	1	-	117	189	106	91	157	178	335	-	-	1	30053
Flamcovent Clean Smart 1 1/4" EP	1.733	1 1/4	-	117	199	110	96	157	178	335	-	-	1	30054
Flamcovent Clean Smart 1 1/2" EP	2.379	1 1/2	-	134	224	129	109	191	212	403	-	-	1	30055
Flamcovent Clean Smart 2" EP	2.816	2	-	134	237	140	117	191	212	403	-	-	1	30056



**Flamco B.V.**

PO Box 502  
3750 GM Bunschoten  
Amersfoortseweg 9  
3751 LJ Bunschoten  
the Netherlands

**T** +31 33 299 75 00

**F** +31 33 298 64 45

**E** [info@flamco.nl](mailto:info@flamco.nl)

**I** [www.flamcogroup.com](http://www.flamcogroup.com)

**Flamco UK Ltd**

Washway Lane  
St Helens  
Merseyside  
WA10 6PB  
United Kingdom

**T** +44 1744 744 744

**F** +44 1744 744 700

**E** [info@flamco.co.uk](mailto:info@flamco.co.uk)

**I** [www.flamcogroup.com](http://www.flamcogroup.com)

**Flamco Middle East**

PO Box 262636  
Jebel Ali  
Dubai  
United Arab Emirates

**T** +971 4 881 95 40

**F** +971 4 881 95 60

**E** [info@flamco-gulf.com](mailto:info@flamco-gulf.com)

**I** [www.flamcogroup.com](http://www.flamcogroup.com)



**Flamco**