

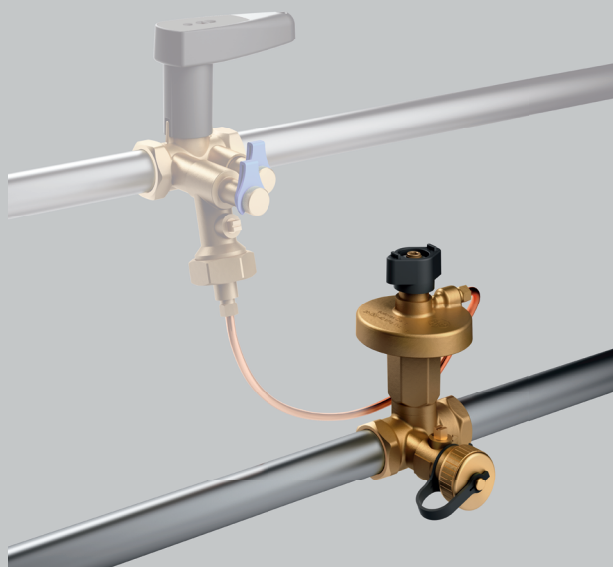

Double Regulating Valve

Nexus Valve
Vertex



NexusValve

Vertex

Table of contents

Chapter NexusValve Vertex DN 10-50

1.	Safety instructions	4
1.1	Rules/regulations	4
1.2	Intended use	5
1.3	Initial operation	5
1.4	Working on the system	5
1.5	Liability	5
2.	Introduction	6
2.1	Description	6
2.2	Benefits	6
2.3	Design	7
2.4	Flow balancing	7
2.5	Operation	8
2.6	Mounting	10
3.	Applications	11
4.	Product data sheet	15
4.1	Product finder	15
4.2	NexusValve Vertex DN 10-50	16
4.2.1	DN 10-50 female/female	16
4.2.2	With drain – DN 10-50 female/female	18
4.3	Flow diagrams	20
4.4	Valve settings	27
4.5	Measuring signal diagrams	34
4.6	Measuring accuracy	41
5.	Accessories	45
6.	Sizing example	46
6.1	NexusValve Vertex system sizing	46
6.2	General specifications DN 10-50	49

1. Safety instructions

Please read the instructions carefully before installation

The installation and initial operation of the assembly may be carried out only by an authorised specialist company. Prior to starting work, familiarise yourself with all parts and how they are handled. The application examples in these operating instructions are ideas sketched out. Local laws and regulations have to be observed.

Target group:

These instructions are intended for authorised specialists exclusively. Work on the heating system, the potable water as well as gas and power network may be carried out by specialists only.



Please follow these safety instructions carefully in order to avoid hazards and damage to people and property.

1.1 Rules/regulations

Please observe the applicable accident prevention regulations, the environmental legislation and the legal rules for mounting, installation and operation. Moreover, please observe the appropriate guidelines of German standard DIN, EN, DVGW, VDI and VDE (including lightning protection) as well as all current relevant country-specific standards, laws and regulations. Old and newly enforced regulations and standards shall apply, if they are relevant for the individual case. Moreover, the regulations of your local energy supply company have to be observed.

Electrical connection:

Electrical wiring work may be carried out by qualified electricians only. The VDE regulations and the specifications of the relevant energy supply company have to be met.

Excerpt:**Installation and construction of heat generators as well as the drinking water heaters:**

DIN EN 4753, Part 1: Water heater and water heating plants for potable and process water.
DIN EN 12828 Heating systems in buildings.
DIN 18 421: Insulation work on technical plants
AV B W a s V Regulations concerning the general conditions for the supply with water
DIN EN 806 ff.: Technical rules for potable water installation
DIN 1988 ff.: Technical rules for potable water installation (national addition)
DIN EN 1717: Protection of potable water against contaminations
DIN 4751: Safety equipment

Electrical connection:

VDE 0100: Erection of electrical equipment, grounding, protective conductor, potential equalisation conductor.
VDE 0701: Repair, modification and testing of electrical devices.
VDE 0185: General aspects on the erection of lightning protection systems.
VDE 0190: Main potential equalisation of electrical plants.
VDE 0855: Installation of antenna plants (shall apply mutatis mutandis).

Additional remarks:

VDI 6002 Sheet 1: General principles, system technology and use in house building

VDI 6002, Sheet 2: Use in students' hostels, retirement homes, hospitals, indoor swimming pools and on camping facilities

Caution:

Prior to any electrical wiring work on pumps and controls, these modules have to be disconnected from voltage correctly.

1.2 Intended use

Inexpert installation as well as use for a purpose not intended of the assembly shall rule out all warranty claims.

All shut-off valves may be closed by an approved specialist only in case of servicing as otherwise the safety valves are not effective.



Do not modify the electrical components, the construction or the hydraulic components! You will impair the safe function of the plant otherwise.

1.3 Initial operation

Prior to the initial operation, the plant has to be tested for tightness, correct hydraulic connection as well as accurate and correct electrical connection. In addition, the plant has to be flushed correctly and/as required in keeping with German standard DIN 4753. The initial operation has to be carried out by a trained specialist, which has to be recorded in writing. In addition, the settings have to be put down in writing.

The technical documentation has to be available at the device.

1.4 Working on the system

The plant has to be de-energised and to be checked for the absence of voltage (such as on the separate fuse or a master switch). Secure the plant against unintentional restart.

(If gas is used as fuel, close the gas shut-off valve and secure against unintentional opening.) Repair work on component parts with a safety-relevant function is impermissible.

1.5 Liability

We reserve all copyrights for this document. Wrongful use, in particular reproduction and forwarding to third parties shall not be permitted.

These installation and operating instructions shall have to be handed to the customer. The executing and/or authorised tradesperson (such as fitter) shall have to explain the function and operation of the plant to the customer in an intelligible manner.

2. Introduction



2.1 Description

NexusValve Vertex is a variable orifice double regulating valve for balancing water-based heating and cooling systems. The balancing performed ensures the required distribution of flow in individual risers and terminal units. Applications are typically central heating or cooling systems, as well as fan coil units in multi-storey and high-rise buildings.

NexusValve Vertex is available in valves DN 10 to DN 50, manufactured in dezincification resistant brass (DZR). For valve sizes DN 65 - 600 the NexusValve Fluctus valve range is recommended.

NexusValve Vertex can optionally be provided with a drain valve. Apart from system draining, the drain valve can also be used to connect a capillary tube from the NexusValve Passim differential pressure control valve. The NexusValve Passim and NexusValve Vertex valves are in combination used for differential pressure control and maximum flow limiting.

2.2 Benefits

- Product range from DN 10 to DN 50 for heating and cooling systems
- Measuring, pre-setting, draining and isolation functions all in one unit
- Compact design for installations in confined spaces
- Flow direction is irrelevant for the valve installation
- Pre-setting is fast and simple using an Allen key
- Setting scale is precise and easy to read
- Isolation of flow is simply done using the quarter-turn handle
- No change in pre-setting when isolated and re-opened
- Drain valve can be rotated 360° for easy service
- Perfect as a partner valve for the NexusValve Passim, differential pressure control valves

2.3 Design

The NexusValve Vertex design enables flow measuring, pre-setting and isolation functions all in one unit. The regulation spindle inside the built-in ball valve is set independently from the isolation function of the ball valve. This allows system flow to be isolated and re-opened again without changing the valve setting. Isolating the system flow is done by a simple quarter-turn of the valve handle. The quarter-turn handle position also makes it easy to identify if the valve is open or closed.

The compact design and the flow bi-directionality ensures easy and flexible installation of NexusValve Vertex in any system.

NexusValve Vertex is optionally provided with a drain valve. This drain valve can be rotated 360° for easy system servicing.

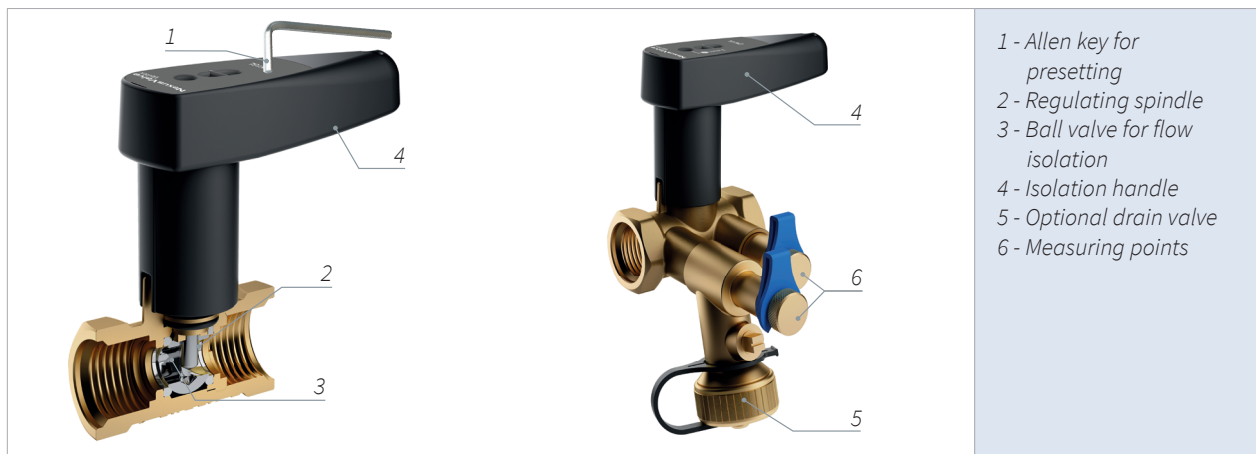

2.4 Flow balancing

NexusValve Vertex is provided with measuring points for differential pressure measurement. When the NexusValve Vertex is pre-set the flow can be validated using any standard flowmeter. Setting is easily done using an Allen key to move the regulating spindle inside the valve and obtain its required position. The setting scale on top of the valve handle displays the precise setting for an – even from a distance – easy read-out.



2. Introduction

NexusValve Vertex can be installed in any position, also regardless of the flow direction. This ensures a flexible and error-free installation with no limitation to supply or return line installations.



NexusValve Vertex is besides the standard threaded connection also available with a selection of Tectite (push fitting) or XPress (press fitting) connectors.

2.5 Operation

NexusValve Vertex can be used as a stand alone balancing valve to provide the desired flow distribution within the controlled system.

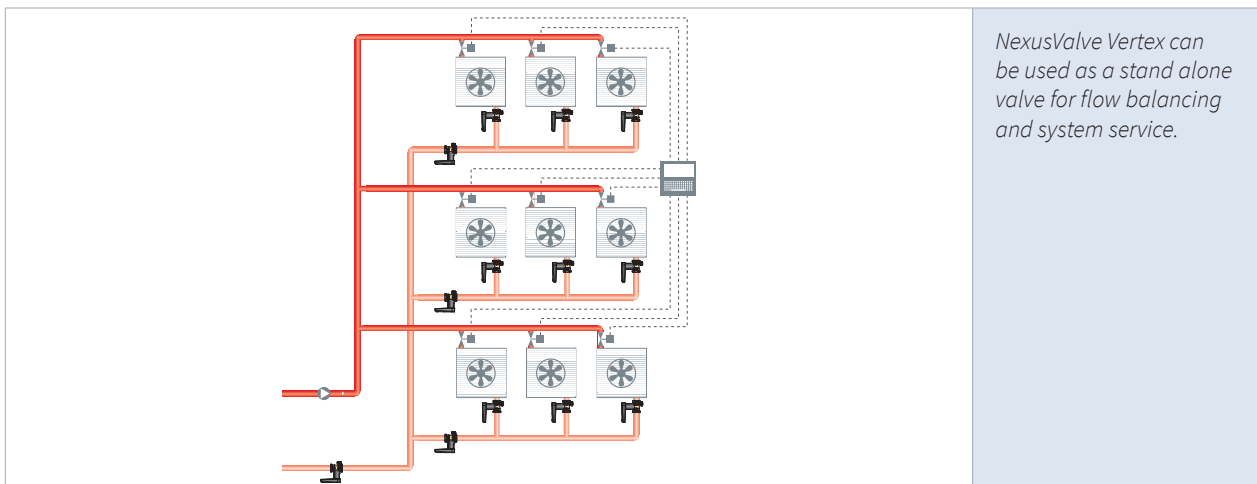

The optional drain valve of the NexusValve Vertex enables at the same time a capillary tube connection to the NexusValve Passim, a differential pressure control valve. By combining NexusValve Vertex and NexusValve Passim in a system branch with terminal units, pressure fluctuations from the remaining part of the system will be eliminated within the branch. The designed flow set on the NexusValve Vertex valve will never be exceeded due to the constant differential pressure regulation performed. System commissioning of a NexusValve Vertex valve in combination with a NexusValve Passim is quick and cost efficient.



NexusValve Vertex and NexusValve Passim can be connected in two ways, having the NexusValve Vertex valve in or outside the controlled circuit.

Having the capillary tube connected to the drain valve of the measuring point with the greater measured pressure, the NexusValve Vertex valve is inside the circuit controlled by the differential pressure control valve. This type of installation is normally used in heating systems with non-presettable thermostatic radiator valves. In this case the pressure loss across the NexusValve Vertex valve needs to be taken into account when setting the differential pressure control valve.

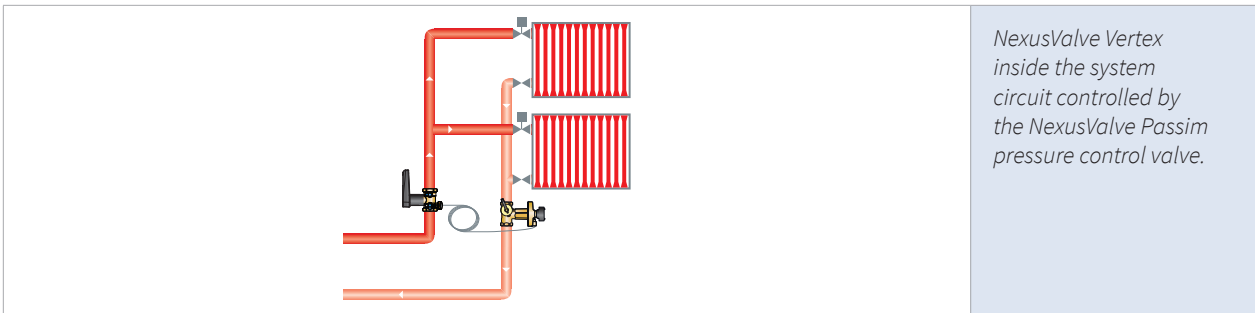

Having the capillary tube connected to the drain valve of the measuring point with the lower measured pressure, the NexusValve Vertex valve is outside the circuit controlled by the differential pressure control valve. This type of installation is normally used in heating systems with pre-settable thermostatic radiator valves. This installation is also advised in cooling and heating systems with balancing valves installed at the terminal units to ensure the required flow. In this case the pressure loss across the NexusValve Vertex valve is not taken into account when setting the differential pressure control valve.

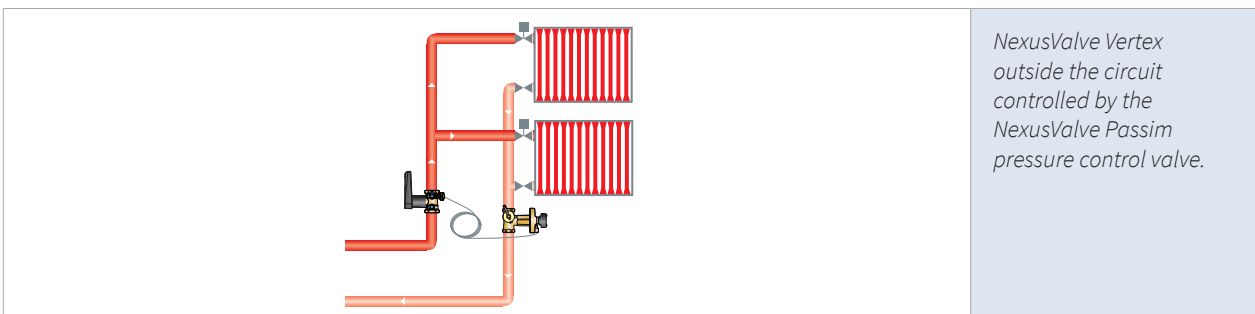

2. Introduction

2.6 Mounting

NexusValve Vertex can be installed regardless of flow direction and 360° around the pipe axis. It requires a straight pipe of 5 × pipe diameter when installed directly after a bend, and 2 × pipe diameter of straight piping when installed directly before a bend. A straight pipe of 10 × pipe diameter is required when NexusValve Vertex is installed directly after the pump. NexusValve Vertex is set using an Allen key to adjust the valve until the required flow is obtained.

3. Applications

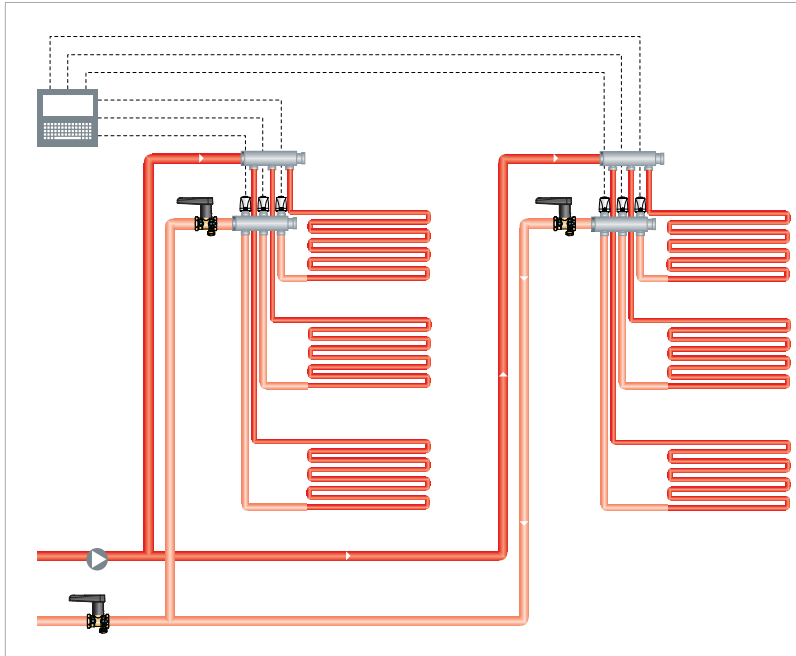

Application 1 - Underfloor heating system

In an underfloor heating system NexusValve Vertex ensures the required flow distribution to all manifolds. Actuators connected to the room thermostat, or the BMS system, control the flow in each loop by opening or closing two-way valves in reference to the air temperature.

The flow and temperature control ensures the required indoor thermal comfort.

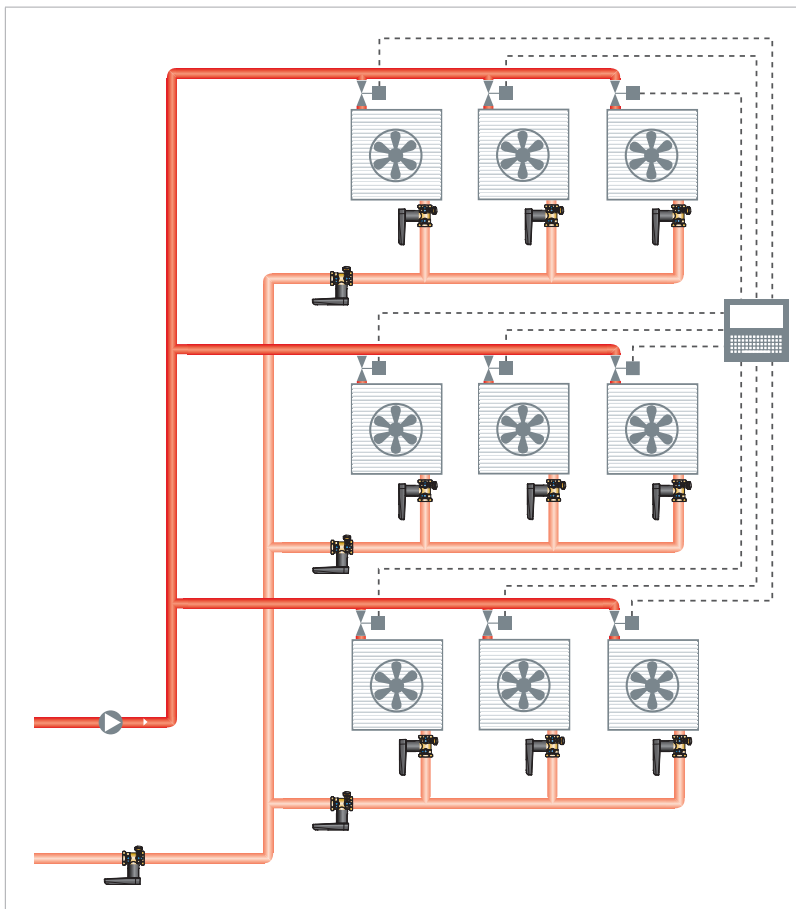

Application 2 - Fan coil system with two-way motorized valves (variable flow system)

In a variable flow system with two-way motorized valves installed, the NexusValve Vertex provides hydronic balance and ensures that all fan coil units have the desired flow at maximum load conditions.

Actuators installed on two-way motorized valves, connected to the room thermostat or BMS system, control the flow in each fan coil unit by opening or closing two-way valves in reference to the air temperature.

The flow and temperature control ensures the required indoor thermal comfort.

3.Applications

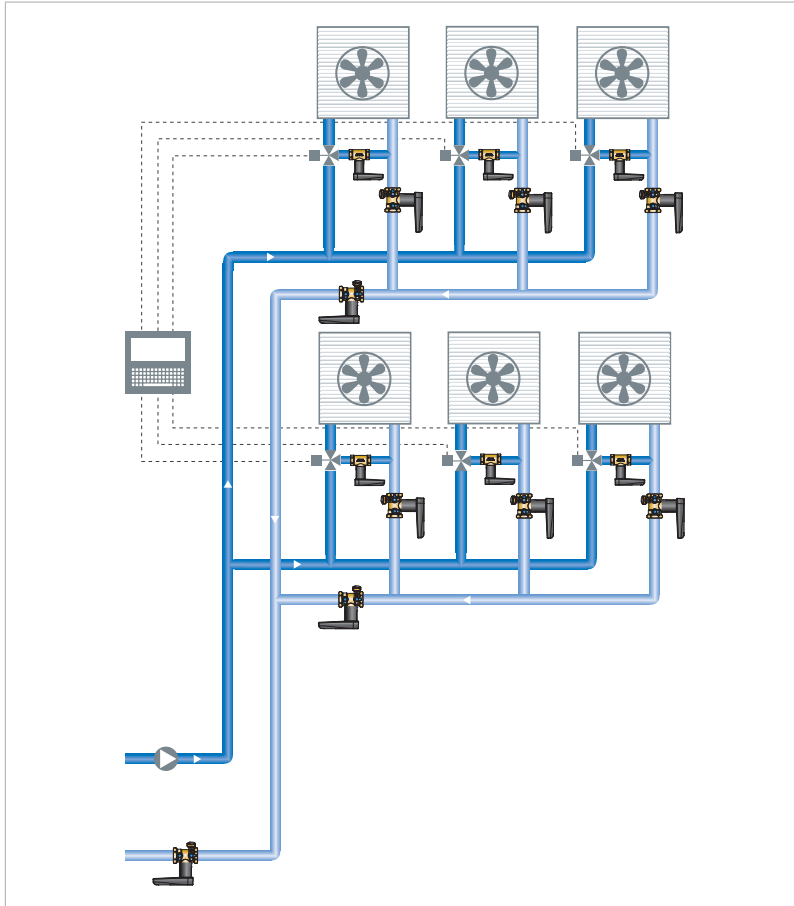

Application 3 - Fan coil system with three-way motorized valves (constant flow system)

In a constant flow system with three-way motorized valves, the NexusValve Vertex provides hydronic balance and ensures that all units have the required flow at maximum load conditions. This is possible as the NexusValve Vertex valves ensure the same pressure loss in the terminal unit branch regardless of the three-way valve position.

Actuators installed on three-way motorized valves, connected to a room thermostat or BMS system, control the flow in each unit by opening or closing the three-way valves in reference to the air temperature.

The flow and temperature control ensure the required indoor thermal comfort.

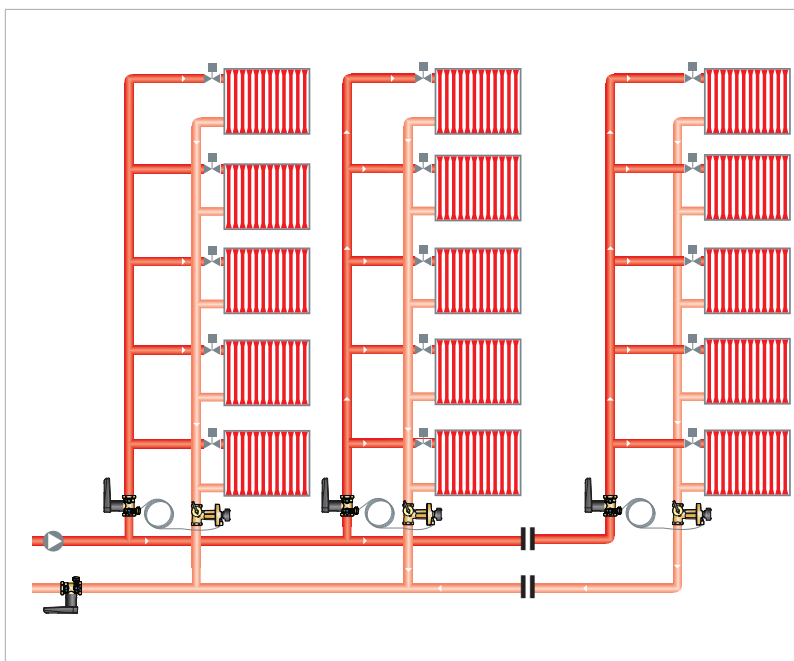

Application 4 - Central heating system with differential pressure control valves

In a central heating system branch having NexusValve Vertex and NexusValve Passim differential pressure control valves installed, pressure fluctuations from the remaining part of the system will be eliminated within the branch. This provides stable pressure and flow conditions, and prevents also possible noise nuisance caused by high differential pressure across radiator thermostats, two-way control valves, or other components in the system.

Balancing a system comprising NexusValve Vertex and NexusValve Passim is quick and cost efficient.

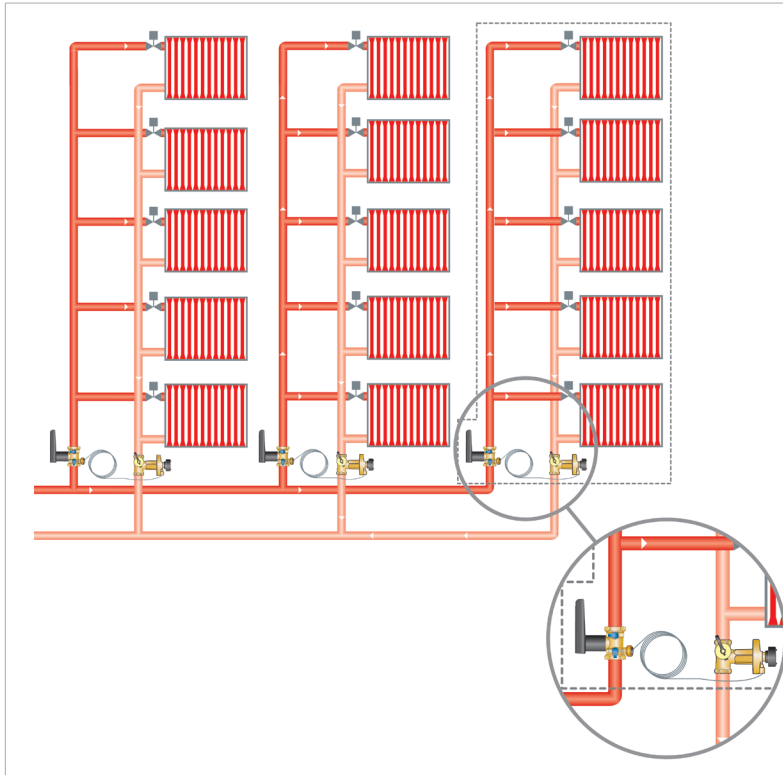

Application 4A - Central heating system with differential pressure control valves

Central heating system with NexusValve Vertex and NexusValve Passim differential pressure control valves connected in a way so that the NexusValve Vertex is inside the controlled circuit. By connecting a capillary tube to the drain valve of the NexusValve Vertex in the measuring point, with the higher measured pressure, the NexusValve Vertex valve is inside the circuit controlled by the NexusValve Passim differential pressure control valve. This type of application is used in heating systems with non-presettable thermostatic radiator valves. In this case the pressure loss across the NexusValve Vertex valve needs to be taken into account when setting the differential pressure control valve. Flow obtained across the NexusValve Vertex valve is kept constant due to constant differential pressure (as long as there is no call for a terminal unit load change).

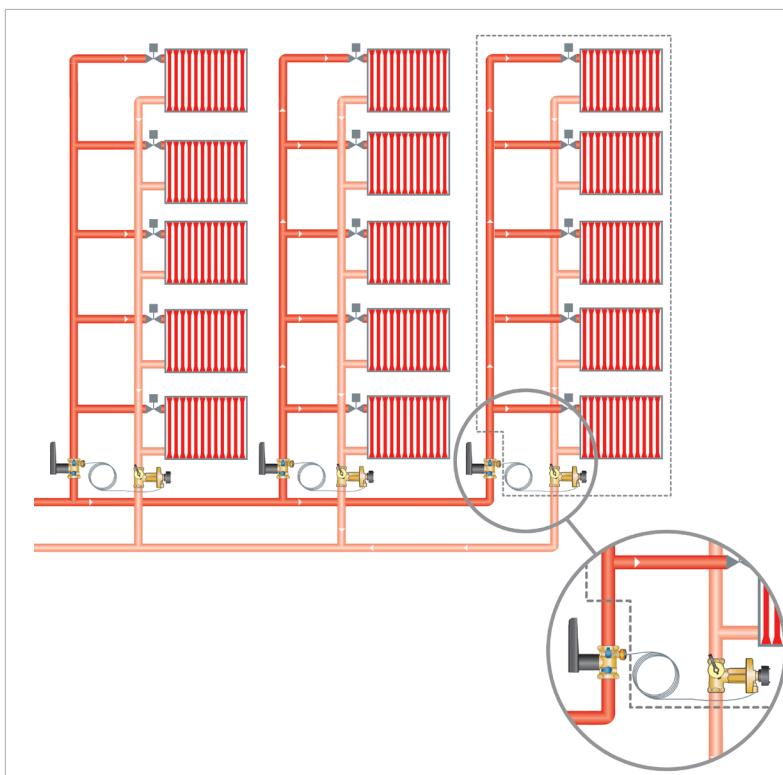

Application 4B - Central heating system with differential pressure control valves

Central heating system with NexusValve Vertex and NexusValve Passim differential pressure control valves connected in a way so that the NexusValve Vertex is outside the controlled circuit. By connecting a capillary tube to the drain valve of the NexusValve Vertex in the measuring point, with the lower measured pressure, the NexusValve Vertex is outside the circuit controlled by the NexusValve Passim differential pressure control valve. This type of application is used in heating systems with pre-settable thermostatic radiator valves. In this case the pressure loss across the NexusValve Vertex is not taken into account when setting the differential pressure control valve. The NexusValve Vertex valve can also be used as a measuring valve to check if the thermostatic radiator valve pre-setting is correct and the designed flow in the riser is achieved.

3.Applications

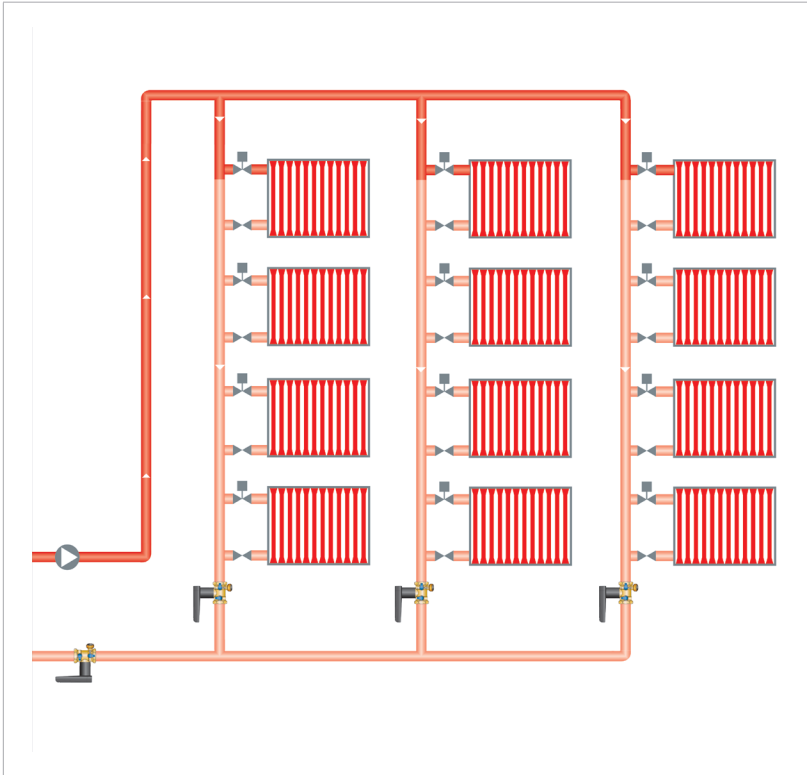

Application 5 - One pipe heating system

The NexusValve Vertex installed in a one pipe heating system ensures the desired flow distribution through all branches and sections.

4. Product data sheet

4.1 Product finder

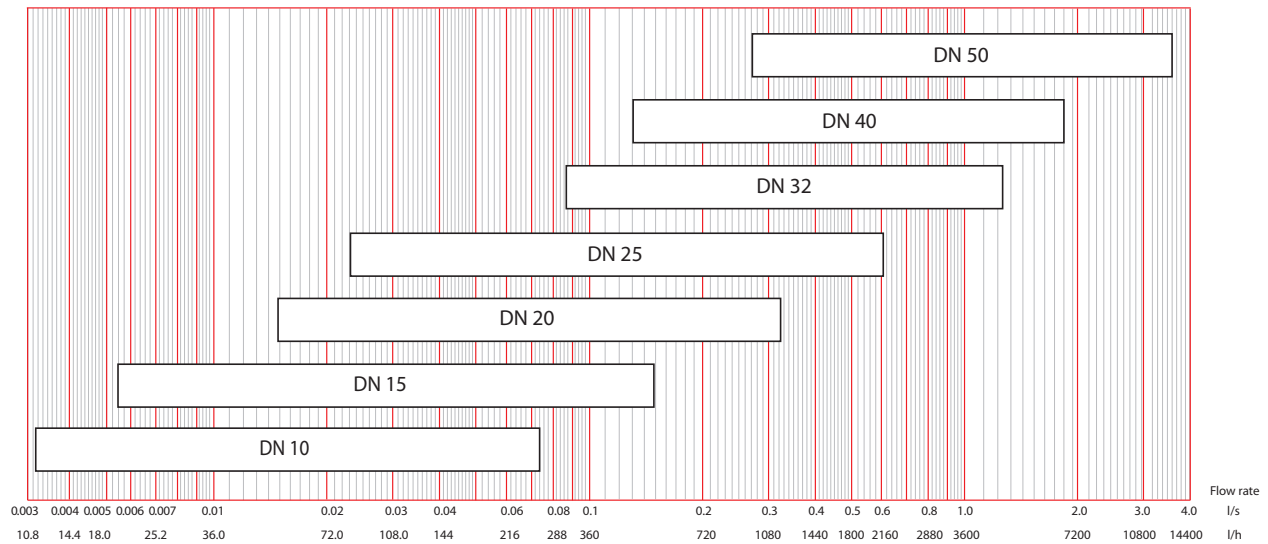

Flow range		Kvs m ³ /h	Dimension	Section
l/s	l/h			
0.00314-0.074	11-270	0.67	DN 10	4.3 - 20
0.0054-0.148	19-530	1.71	DN 15	4.3 - 21
0.015-0.325	55-1170	4.40	DN 20	4.3 - 22
0.023-0.603	84-2170	7.46	DN 25	4.3 - 23
0.087-1.25	310-4500	13.50	DN 32	4.3 - 24
0.13-1.88	450-6770	23.70	DN 40	4.3 - 25
0.27-3.51	960-12640	34.50	DN 50	4.3 - 26

4. Product data sheet

4.2 NexusValve Vertex DN 10-50

4.2.1 DN 10-50 female/female

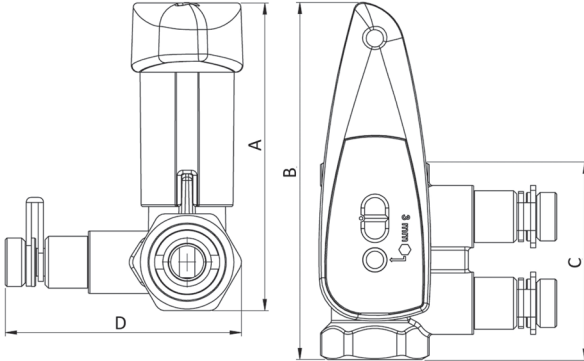
Dimensions	Specifications
	<p>Max. temperature 120°C Min. temperature -20°C Max. pressure 25 bar Press ends 16 bar Marking on valve (Handle) DN, Allen key size (Valve body) DN, PN</p> <p>Connection Female thread ISO 7/1 parallel</p> <p>Valve housing DR Brass CW602N CuZn36Pb2As DR Brass CW602N (chrome plated)</p> <p>Ball and needle Polyamide (PA6.6 30%GF)</p> <p>Valve handle Polyamide (PA6.6 30%GF)</p> <p>Sealings O-rings EPDM Gaskets PTFE Test point sealing EPDM</p>

DN	A (mm)	B (mm)	C (mm)	D (mm)
DN 10	89	110	72	68
DN 15	89	103	58	68
DN 20	94	106	63	74
DN 25	102	112	76	80
DN 32	137	165	89	88
DN 40	144	170	98	94
DN 50	159	180	119	106

Note! Information on insulation jackets, press adaptors and other is provided in the chapter Accessories.

Valve	Article	Nom. Inch	Kvs m ³ /h	Flow range l/h
DN 10 	MN80597.699	3/8"	0.67	11-270
DN 15 	MN80597.700	1/2"	1.71	19-530
DN 20 	MN80597.701	3/4"	4.40	55-1170
DN 25 	MN80597.702	1"	7.46	84-2170
DN 32 	MN80597.703	1 1/4"	13.5	310-4500
DN 40 	MN80597.704	1 1/2"	23.7	450-6670
DN 50 	MN80597.705	2"	34,5	960-12640

4. Product data sheet

4.2.2 With drain - DN 10-50 female/female

Dimensions

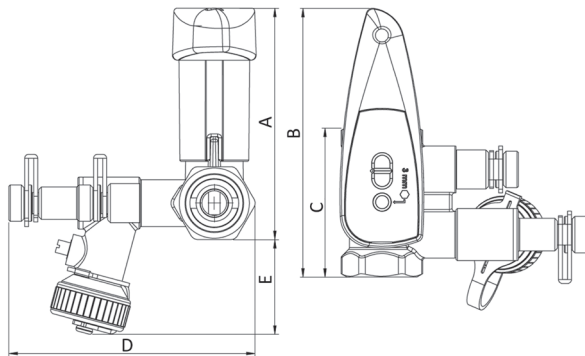



Specifications

Max. temperature	120°C
Min. temperature	-20°C
Max. pressure	25 bar
Press ends	16 bar
Marking on valve	(Handle) DN, Allen key size (Valve body) DN, PN
Connection	Female thread ISO 7/1 parallel
Valve housing	DR Brass CW602N CuZn36Pb2As
Ball and needle	DR Brass CW602N (chrome plated)
Valve handle	Polyamide (PA6.6 30%GF)
Sealings	O-rings EPDM Gaskets PTFE Test point sealing EPDM

DN	A (mm)	B (mm)	C (mm)	D (mm)	E (mm)
DN 10	89	106	63	95	36
DN 15	89	103	58	95	36
DN 20	94	106	63	101	33
DN 25	102	112	76	107	30
DN 32	137	165	89	114	22
DN 40	144	170	98	120	18
DN 50	159	180	119	133	10

Note! Information on insulation jackets, press adaptors and other is provided in the chapter Accessories.

Valve	Article	Nom. Inch	Kvs m ³ /h	Flow range l/h
DN 10 	MN80597.7112	3/8"	0.67	11-270
DN 15 	MN80597.706	1/2"	1.71	19-530
DN 20 	MN80597.707	3/4"	4.40	55-1170
DN 25 	MN80597.708	1"	7.46	84-2170
DN 32 	MN80597.709	1 1/4"	13.5	310-4500
DN 40 	MN80597.710	1 1/2"	23.7	450-6670
DN 50 	MN80597.711	2"	34,5	960-12640

4. Product data sheet

4.3 Flow diagrams

The graph is used to determine the total pressure loss across the NexusValve Vertex valve at a given pre-setting and flow rate.

The minimum digital scale setting is 0.0 and the maximum setting (fully open valve) is 9.9. One hundred different positions, at an increment of 0.1, are possible, and each position corresponds to a different Kv value.

The Kv value and the Kvs value (at a fully open valve) refer to the pressure loss across the entire valve. These values are used for system sizing and pump selection. The Kv and the Kvs values differ from the Kvm value which is connected to the pressure loss at the measuring points. This difference is a result of turbulence occurring in the measuring area. The Kvm value is used during system balancing to secure correct flow readings from the flowmeter. The Kvm value corresponding to a specific NexusValve Vertex valve setting is typed into the flowmeter for a flow read-out.

A pressure loss of up to 250 kPa is allowed across the NexusValve Vertex valve. Within the working range it should be assured that cavitation does not occur at any given pressure loss.

Valve sizing example is provided in chapter 6.

DN 10 - female/female

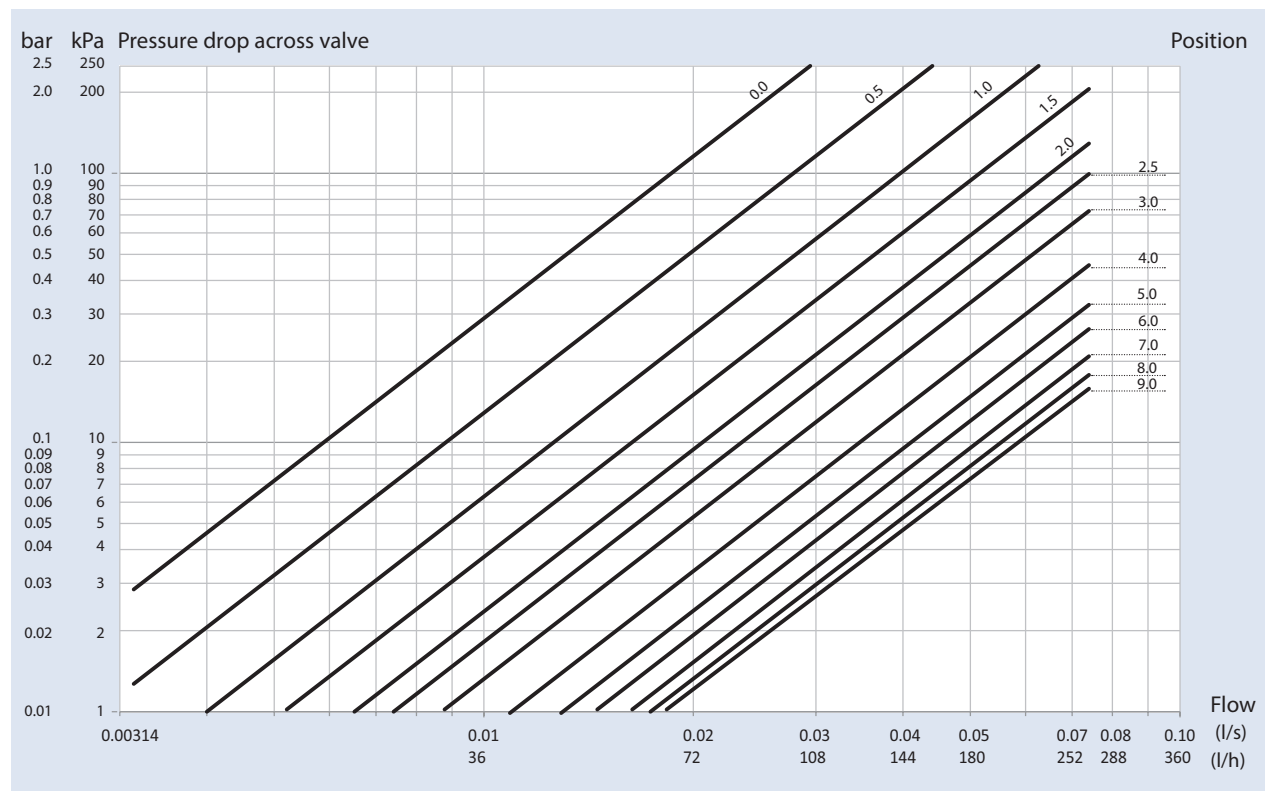

DN 15 - female/female

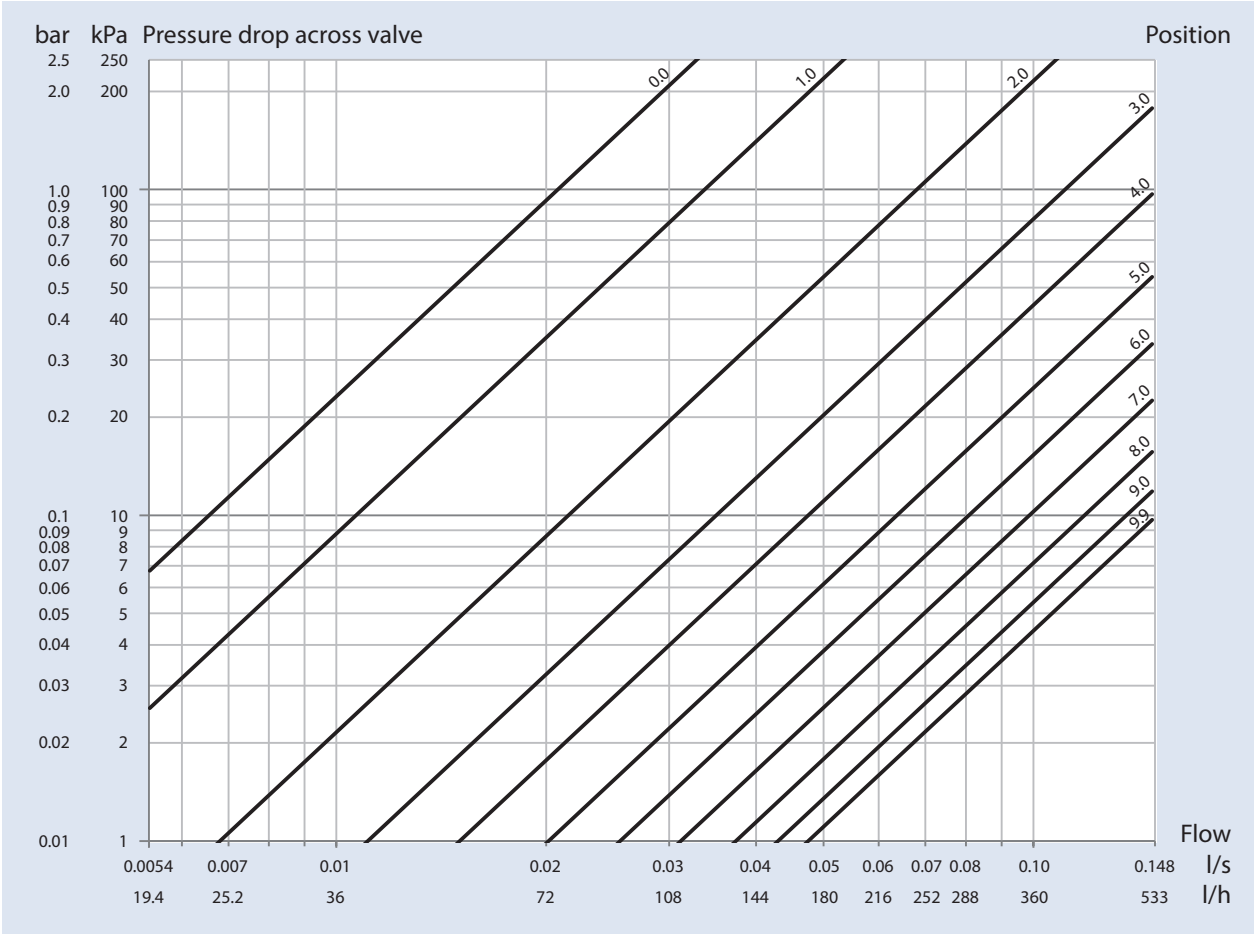

4. Product data sheet

DN 20 - female/female

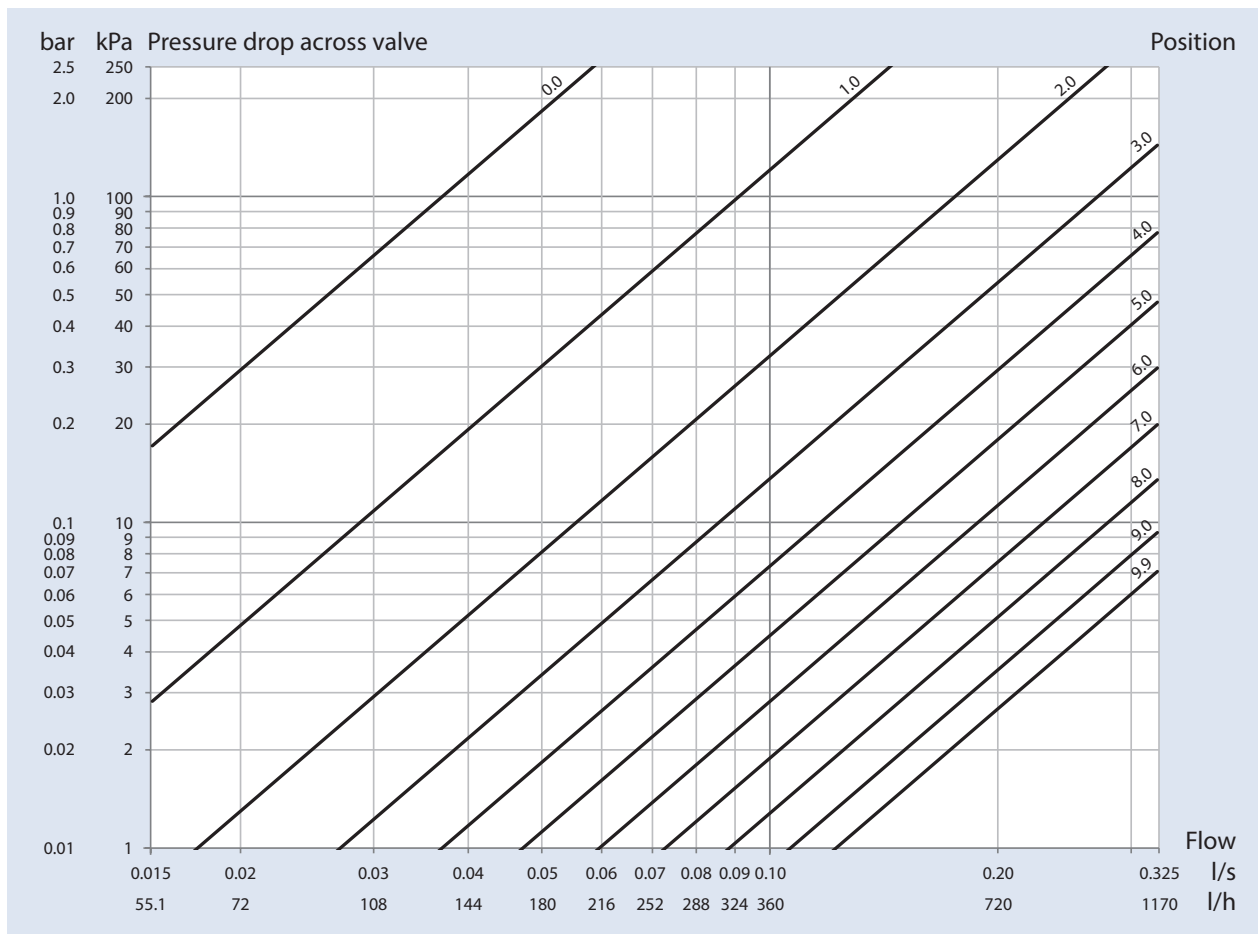

DN 25 - female/female

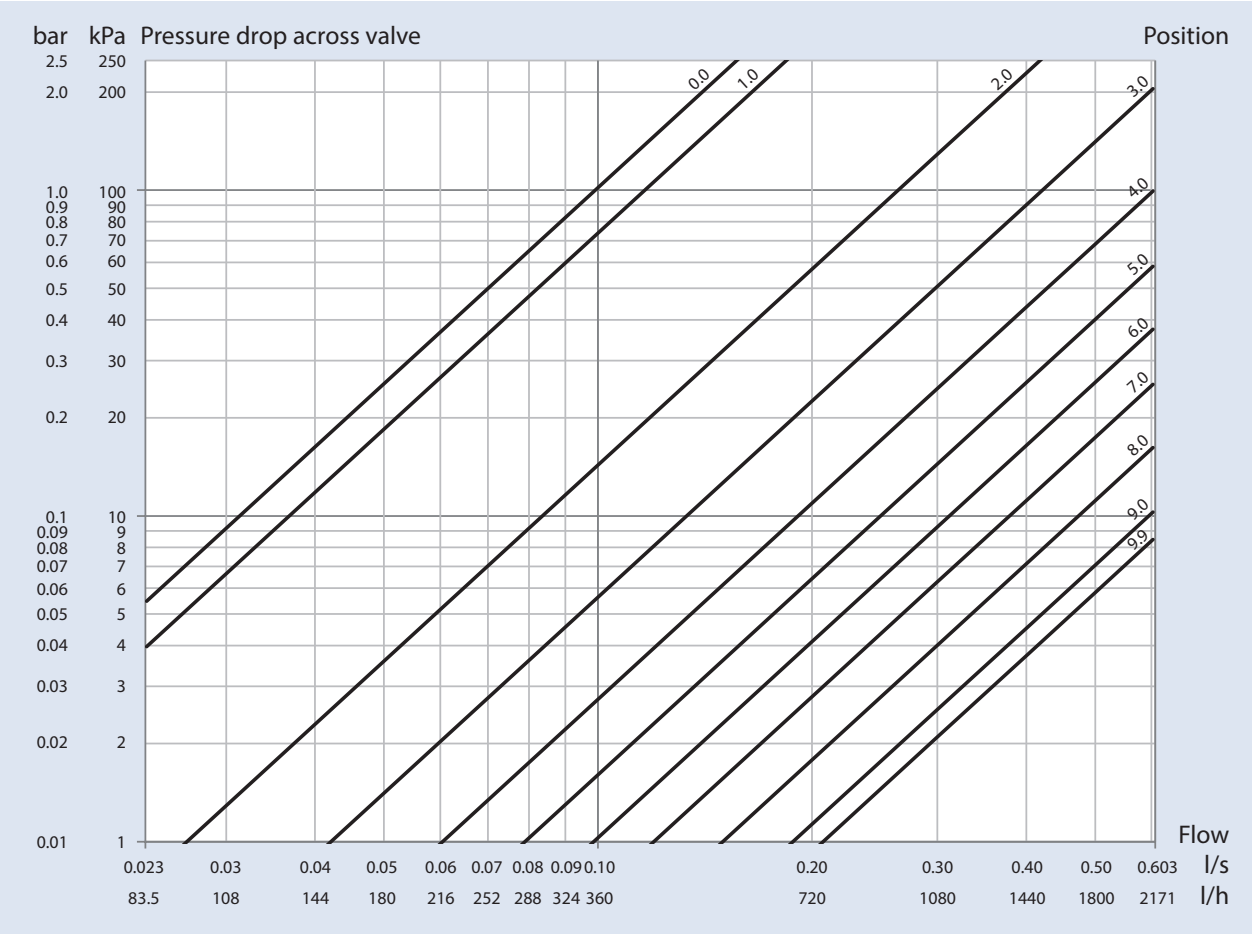

4. Product data sheet

DN 32 - female/female

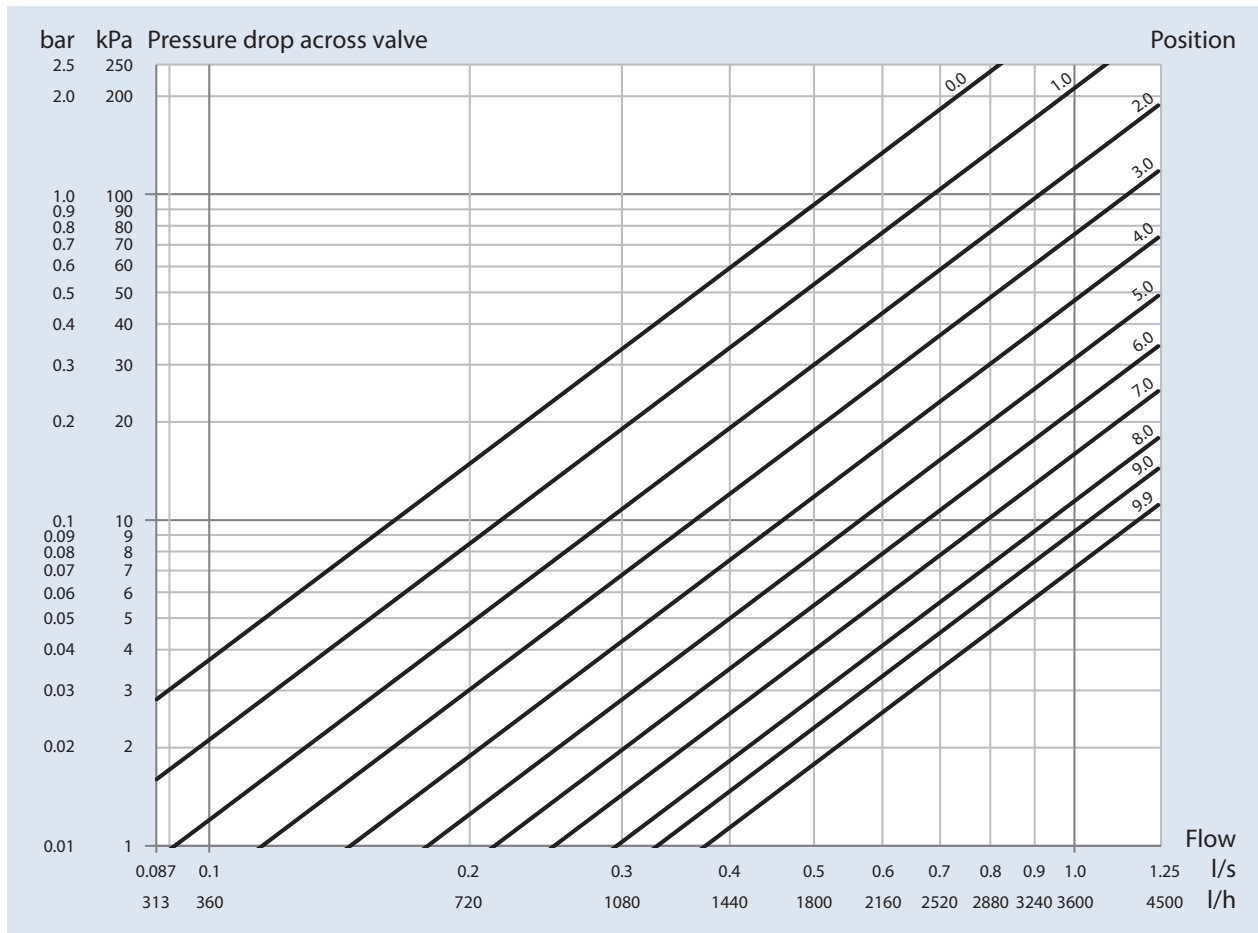

DN 40 - female/female

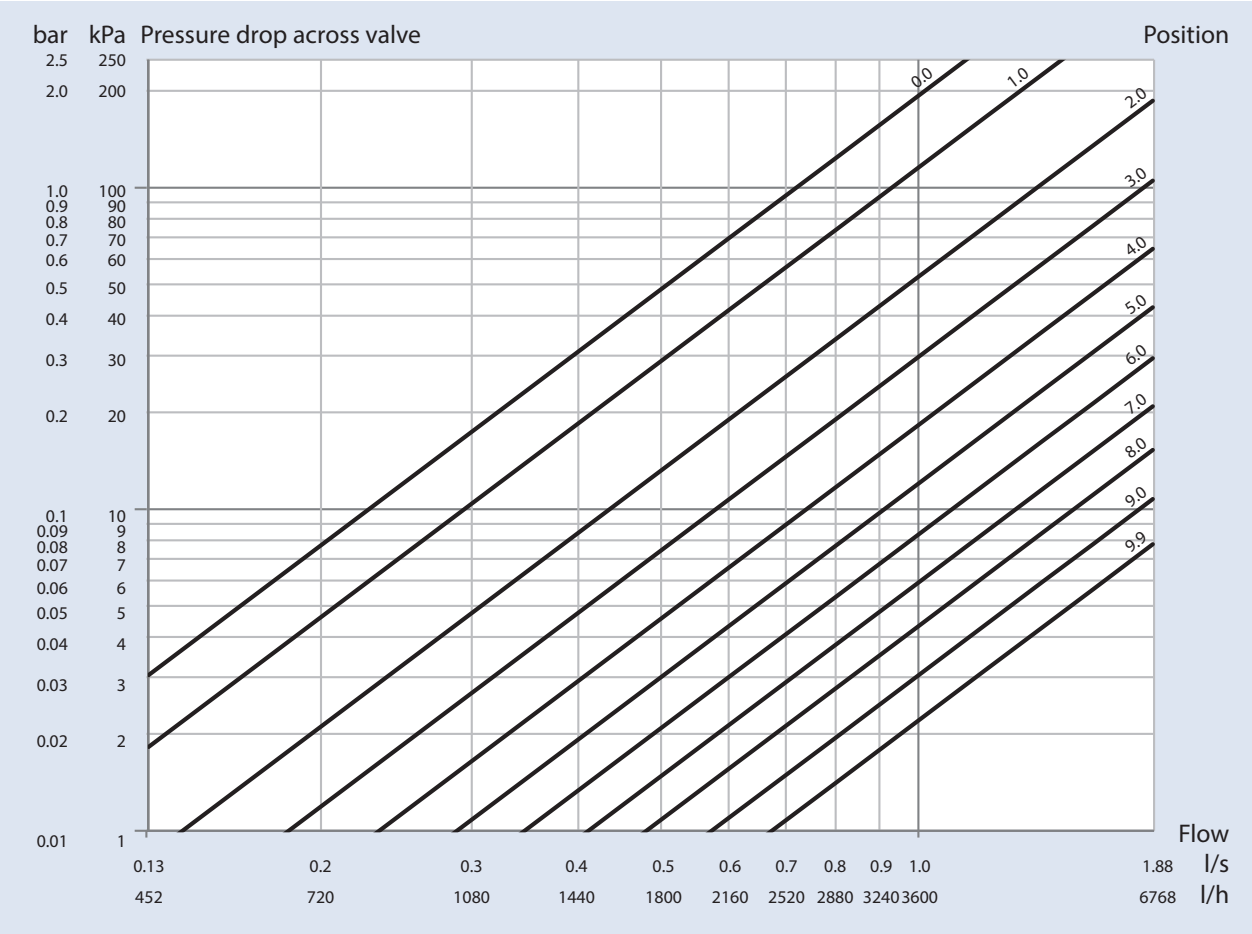

4. Product data sheet

DN 50 - female/female

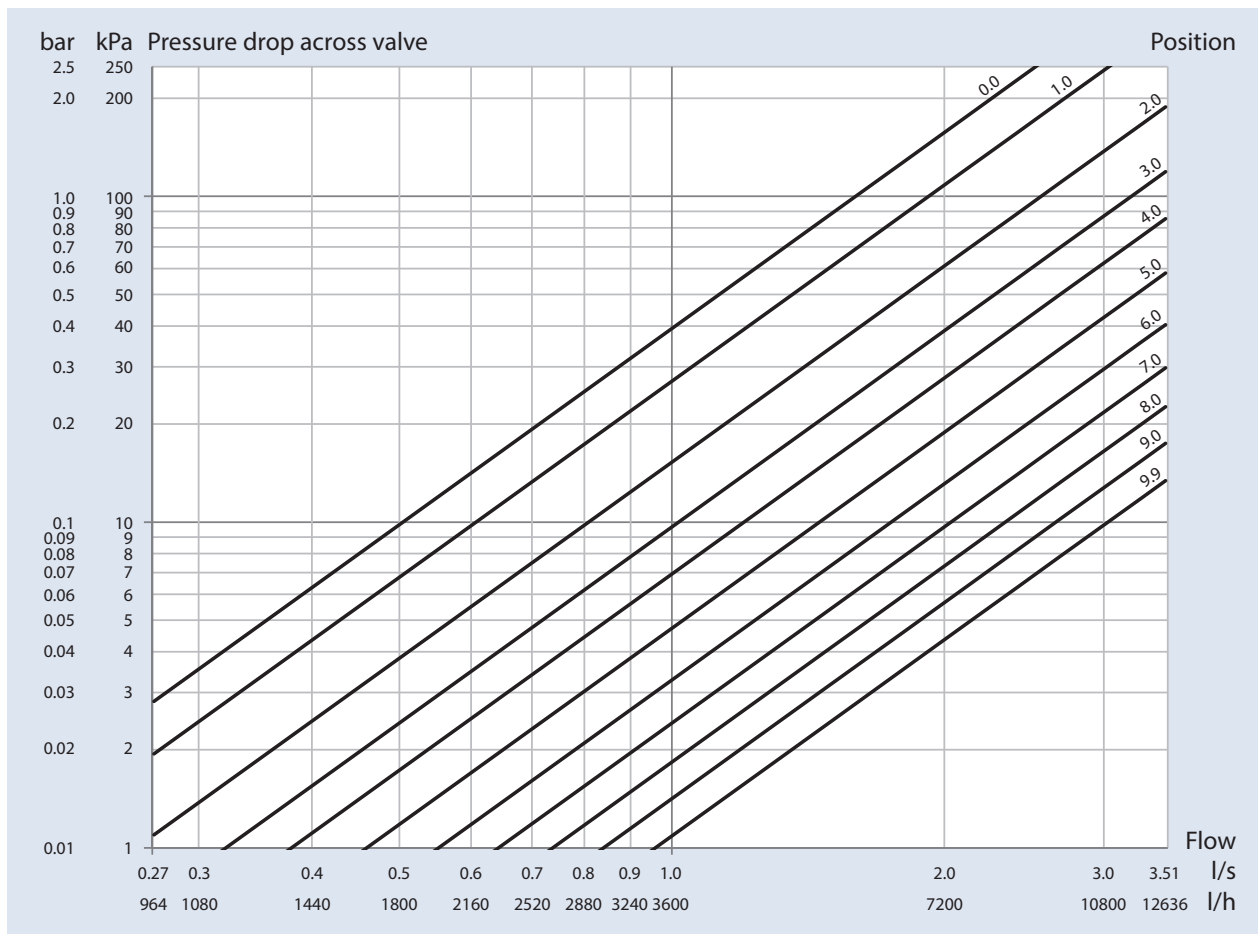

4.4 Valve settings

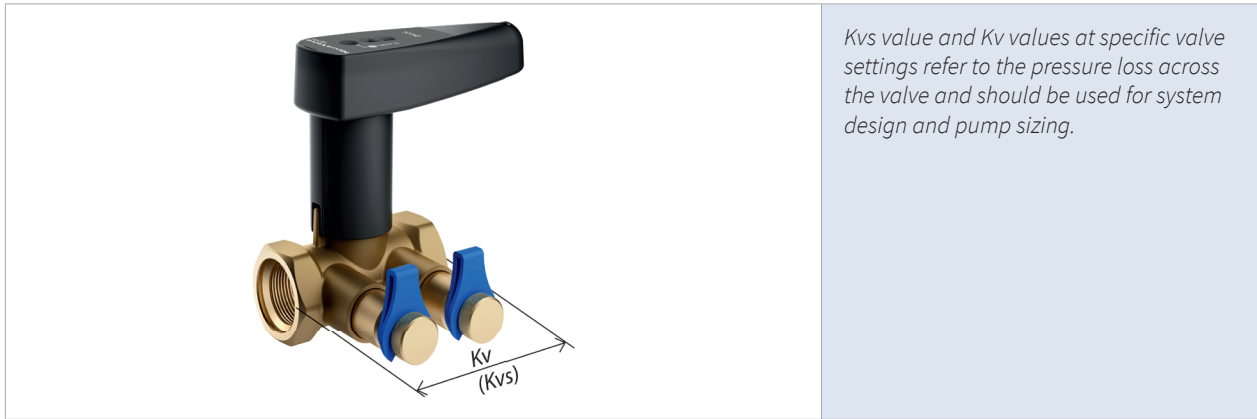

DN 10 - female/female

Setting	Kvs m ³ /h	Setting	Kvs m ³ /h	Setting	Kvs m ³ /h	Setting	Kvs m ³ /h	Setting	Kvs m ³ /h
0.0	0.065	1.0	0.144	2.0	0.227	3.0	0.311	4.0	0.392
0.1	0.073	1.1	0.152	2.1	0.235	3.1	0.319	4.1	0.400
0.2	0.080	1.2	0.160	2.2	0.244	3.2	0.328	4.2	0.407
0.3	0.088	1.3	0.168	2.3	0.252	3.3	0.336	4.3	0.415
0.4	0.096	1.4	0.177	2.4	0.261	3.4	0.344	4.4	0.423
0.5	0.104	1.5	0.185	2.5	0.269	3.5	0.352	4.5	0.430
0.6	0.112	1.6	0.193	2.6	0.277	3.6	0.360	4.6	0.438
0.7	0.120	1.7	0.202	2.7	0.286	3.7	0.368	4.7	0.445
0.8	0.128	1.8	0.210	2.8	0.294	3.8	0.376	4.8	0.452
0.9	0.136	1.9	0.218	2.9	0.303	3.9	0.384	4.9	0.459

Setting	Kvs m ³ /h	Setting	Kvs m ³ /h	Setting	Kvs m ³ /h	Setting	Kvs m ³ /h	Setting	Kvs m ³ /h
5.0	0.466	6.0	0.530	7.0	0.582	8.0	0.622	9.0	0.652
5.1	0.473	6.1	0.536	7.1	0.586	8.1	0.625	9.1	0.654
5.2	0.480	6.2	0.541	7.2	0.591	8.2	0.628	9.2	0.657
5.3	0.486	6.3	0.547	7.3	0.595	8.3	0.631	9.3	0.660
5.4	0.493	6.4	0.552	7.4	0.599	8.4	0.635	9.4	0.662
5.5	0.499	6.5	0.557	7.5	0.603	8.5	0.638	9.5	0.665
5.6	0.506	6.6	0.563	7.6	0.607	8.6	0.641	9.6	0.668
5.7	0.512	6.7	0.568	7.7	0.611	8.7	0.643	9.7	0.670
5.8	0.518	6.8	0.572	7.8	0.614	8.8	0.646	9.8	0.673
5.9	0.524	6.9	0.577	7.9	0.618	8.9	0.649	9.9	0.675

Note! In order to provide high measuring accuracy the entire setting range applies – except settings 0.0-0.9.

4. Product data sheet

DN 15 - female/female

Setting	Kvs m ³ /h	Setting	Kvs m ³ /h	Setting	Kvs m ³ /h	Setting	Kvs m ³ /h	Setting	Kvs m ³ /h
0.0	0.06	1.0	0.11	2.0	0.25	3.0	0.40	4.0	0.55
0.1	0.06	1.1	0.12	2.1	0.26	3.1	0.41	4.1	0.57
0.2	0.06	1.2	0.13	2.2	0.28	3.2	0.43	4.2	0.58
0.3	0.06	1.3	0.15	2.3	0.29	3.3	0.44	4.3	0.60
0.4	0.07	1.4	0.16	2.4	0.31	3.4	0.46	4.4	0.62
0.5	0.07	1.5	0.17	2.5	0.32	3.5	0.47	4.5	0.63
0.6	0.08	1.6	0.19	2.6	0.34	3.6	0.49	4.6	0.65
0.7	0.08	1.7	0.20	2.7	0.35	3.7	0.50	4.7	0.67
0.8	0.09	1.8	0.22	2.8	0.37	3.8	0.52	4.8	0.68
0.9	0.10	1.9	0.23	2.9	0.38	3.9	0.53	4.9	0.70

Setting	Kvs m ³ /h	Setting	Kvs m ³ /h	Setting	Kvs m ³ /h	Setting	Kvs m ³ /h	Setting	Kvs m ³ /h
5.0	0.72	6.0	0.91	7.0	1.13	8.0	1.35	9.0	1.55
5.1	0.74	6.1	0.93	7.1	1.15	8.1	1.37	9.1	1.57
5.2	0.76	6.2	0.96	7.2	1.18	8.2	1.40	9.2	1.59
5.3	0.77	6.3	0.98	7.3	1.20	8.3	1.42	9.3	1.61
5.4	0.79	6.4	1.00	7.4	1.22	8.4	1.44	9.4	1.63
5.5	0.81	6.5	1.02	7.5	1.24	8.5	1.46	9.5	1.64
5.6	0.83	6.6	1.04	7.6	1.27	8.6	1.48	9.6	1.66
5.7	0.85	6.7	1.06	7.7	1.29	8.7	1.50	9.7	1.68
5.8	0.87	6.8	1.09	7.8	1.31	8.8	1.52	9.8	1.69
5.9	0.89	6.9	1.11	7.9	1.33	8.9	1.54	9.9	1.71

Note! In order to provide high measuring accuracy the entire setting range applies – except settings 0.0-0.9.

DN 20 - female/female

Setting	Kvs m ³ /h	Setting	Kvs m ³ /h	Setting	Kvs m ³ /h	Setting	Kvs m ³ /h	Setting	Kvs m ³ /h
0.0	0.12	1.0	0.31	2.0	0.64	3.0	0.98	4.0	1.33
0.1	0.13	1.1	0.34	2.1	0.67	3.1	1.02	4.1	1.37
0.2	0.14	1.2	0.37	2.2	0.70	3.2	1.05	4.2	1.40
0.3	0.16	1.3	0.40	2.3	0.74	3.3	1.09	4.3	1.44
0.4	0.17	1.4	0.44	2.4	0.77	3.4	1.12	4.4	1.48
0.5	0.19	1.5	0.47	2.5	0.81	3.5	1.16	4.5	1.51
0.6	0.21	1.6	0.50	2.6	0.84	3.6	1.19	4.6	1.55
0.7	0.24	1.7	0.53	2.7	0.88	3.7	1.23	4.7	1.59
0.8	0.26	1.8	0.57	2.8	0.91	3.8	1.26	4.8	1.63
0.9	0.29	1.9	0.60	2.9	0.95	3.9	1.30	4.9	1.66

Setting	Kvs m ³ /h	Setting	Kvs m ³ /h	Setting	Kvs m ³ /h	Setting	Kvs m ³ /h	Setting	Kvs m ³ /h
5.0	1.70	6.0	2.13	7.0	2.63	8.0	3.20	9.0	3.82
5.1	1.74	6.1	2.18	7.1	2.68	8.1	3.26	9.1	3.88
5.2	1.78	6.2	2.22	7.2	2.74	8.2	3.32	9.2	3.95
5.3	1.82	6.3	2.27	7.3	2.79	8.3	3.38	9.3	4.01
5.4	1.87	6.4	2.32	7.4	2.85	8.4	3.44	9.4	4.08
5.5	1.91	6.5	2.37	7.5	2.91	8.5	3.50	9.5	4.14
5.6	1.95	6.6	2.42	7.6	2.96	8.6	3.57	9.6	4.21
5.7	1.99	6.7	2.47	7.7	3.02	8.7	3.63	9.7	4.27
5.8	2.04	6.8	2.52	7.8	3.08	8.8	3.69	9.8	4.34
5.9	2.08	6.9	2.57	7.9	3.14	8.9	3.76	9.9	4.40

Note! In order to provide high measuring accuracy the entire setting range applies – except settings 0.0-0.9.

4. Product data sheet

DN 25 - female/female

Setting	Kvs m ³ /h	Setting	Kvs m ³ /h	Setting	Kvs m ³ /h	Setting	Kvs m ³ /h	Setting	Kvs m ³ /h
0.0	0.34	1.0	0.48	2.0	0.93	3.0	1.55	4.0	2.21
0.1	0.34	1.1	0.51	2.1	0.98	3.1	1.62	4.1	2.27
0.2	0.34	1.2	0.55	2.2	1.04	3.2	1.68	4.2	2.34
0.3	0.35	1.3	0.59	2.3	1.10	3.3	1.75	4.3	2.40
0.4	0.35	1.4	0.63	2.4	1.16	3.4	1.81	4.4	2.47
0.5	0.37	1.5	0.67	2.5	1.23	3.5	1.88	4.5	2.53
0.6	0.38	1.6	0.72	2.6	1.29	3.6	1.95	4.6	2.59
0.7	0.40	1.7	0.77	2.7	1.35	3.7	2.01	4.7	2.66
0.8	0.42	1.8	0.82	2.8	1.42	3.8	2.08	4.8	2.72
0.9	0.45	1.9	0.87	2.9	1.48	3.9	2.14	4.9	2.78

Setting	Kvs m ³ /h	Setting	Kvs m ³ /h	Setting	Kvs m ³ /h	Setting	Kvs m ³ /h	Setting	Kvs m ³ /h
5.0	2.85	6.0	3.51	7.0	4.31	8.0	5.35	9.0	6.57
5.1	2.91	6.1	3.58	7.1	4.40	8.1	5.47	9.1	6.69
5.2	2.97	6.2	3.65	7.2	4.50	8.2	5.59	9.2	6.81
5.3	3.04	6.3	3.73	7.3	4.59	8.3	5.71	9.3	6.92
5.4	3.10	6.4	3.80	7.4	4.69	8.4	5.83	9.4	7.03
5.5	3.17	6.5	3.88	7.5	4.80	8.5	5.96	9.5	7.13
5.6	3.23	6.6	3.96	7.6	4.90	8.6	6.08	9.6	7.23
5.7	3.30	6.7	4.04	7.7	5.01	8.7	6.20	9.7	7.32
5.8	3.37	6.8	4.13	7.8	5.12	8.8	6.33	9.8	7.40
5.9	3.44	6.9	4.22	7.9	5.24	8.9	6.45	9.9	7.46

Note! In order to provide high measuring accuracy the entire setting range applies – except settings 0.0-0.9.

DN 32 - female/female

Setting	Kvs m ³ /h	Setting	Kvs m ³ /h	Setting	Kvs m ³ /h	Setting	Kvs m ³ /h	Setting	Kvs m ³ /h
0.0	1.85	1.0	2.45	2.0	3.28	3.0	4.20	4.0	5.24
0.1	1.89	1.1	2.53	2.1	3.36	3.1	4.30	4.1	5.34
0.2	1.94	1.2	2.61	2.2	3.45	3.2	4.40	4.2	5.46
0.3	1.99	1.3	2.69	2.3	3.54	3.3	4.50	4.3	5.57
0.4	2.05	1.4	2.77	2.4	3.63	3.4	4.60	4.4	5.69
0.5	2.11	1.5	2.85	2.5	3.73	3.5	4.70	4.5	5.80
0.6	2.17	1.6	2.93	2.6	3.82	3.6	4.81	4.6	5.92
0.7	2.24	1.7	3.02	2.7	3.91	3.7	4.91	4.7	6.04
0.8	2.31	1.8	3.10	2.8	4.01	3.8	5.02	4.8	6.16
0.9	2.38	1.9	3.19	2.9	4.10	3.9	5.13	4.9	6.29

Setting	Kvs m ³ /h	Setting	Kvs m ³ /h	Setting	Kvs m ³ /h	Setting	Kvs m ³ /h	Setting	Kvs m ³ /h
5.0	6.41	6.0	7.71	7.0	9.08	8.0	10.46	9.0	11.91
5.1	6.54	6.1	7.84	7.1	9.21	8.1	10.60	9.1	12.07
5.2	6.66	6.2	7.98	7.2	9.35	8.2	10.74	9.2	12.23
5.3	6.79	6.3	8.12	7.3	9.49	8.3	10.88	9.3	12.40
5.4	6.92	6.4	8.25	7.4	9.63	8.4	11.02	9.4	12.57
5.5	7.05	6.5	8.39	7.5	9.76	8.5	11.16	9.5	12.75
5.6	7.18	6.6	8.53	7.6	9.99	8.6	11.31	9.6	12.93
5.7	7.31	6.7	8.66	7.7	10.04	8.7	11.45	9.7	13.12
5.8	7.44	6.8	8.80	7.8	10.18	8.8	11.60	9.8	13.33
5.9	7.58	6.9	8.94	7.9	10.32	8.9	11.75	9.9	13.48

4. Product data sheet

DN 40 - female/female

Setting	Kvs m ³ /h	Setting	Kvs m ³ /h	Setting	Kvs m ³ /h	Setting	Kvs m ³ /h	Setting	Kvs m ³ /h
0.0	2.70	1.0	3.57	2.0	4.96	3.0	6.64	4.0	8.45
0.1	2.75	1.1	3.69	2.1	5.12	3.1	6.82	4.1	8.63
0.2	2.82	1.2	3.81	2.2	5.28	3.2	6.99	4.2	8.82
0.3	2.89	1.3	3.94	2.3	5.44	3.3	7.17	4.3	9.01
0.4	2.97	1.4	4.08	2.4	5.61	3.4	7.35	4.4	9.20
0.5	3.05	1.5	4.22	2.5	5.78	3.5	7.53	4.5	9.39
0.6	3.14	1.6	4.36	2.6	5.95	3.6	7.71	4.6	9.58
0.7	3.24	1.7	4.51	2.7	6.12	3.7	7.90	4.7	9.77
0.8	3.34	1.8	4.65	2.8	6.29	3.8	8.08	4.8	9.96
0.9	3.45	1.9	4.81	2.9	6.46	3.9	8.26	4.9	10.15

Setting	Kvs m ³ /h	Setting	Kvs m ³ /h	Setting	Kvs m ³ /h	Setting	Kvs m ³ /h	Setting	Kvs m ³ /h
5.0	10.35	6.0	12.39	7.0	14.70	8.0	17.40	9.0	20.55
5.1	10.54	6.1	12.61	7.1	14.95	8.1	17.69	9.1	20.89
5.2	10.74	6.2	12.83	7.2	15.20	8.2	17.99	9.2	21.24
5.3	10.94	6.3	13.05	7.3	15.46	8.3	18.30	9.3	21.58
5.4	11.14	6.4	13.27	7.4	15.72	8.4	18.61	9.4	21.93
5.5	11.35	6.5	13.50	7.5	15.99	8.5	18.92	9.5	22.28
5.6	11.55	6.6	13.73	7.6	16.26	8.6	19.24	9.6	22.63
5.7	11.76	6.7	13.97	7.7	16.54	8.7	19.56	9.7	22.99
5.8	11.97	6.8	14.21	7.8	16.82	8.8	19.89	9.8	23.34
5.9	12.18	6.9	14.45	7.9	17.11	8.9	20.22	9.9	23.68

DN 50 - female/female

Setting	Kvs m ³ /h	Setting	Kvs m ³ /h	Setting	Kvs m ³ /h	Setting	Kvs m ³ /h	Setting	Kvs m ³ /h
0.0	5.71	1.0	7.03	2.0	9.22	3.0	11.48	4.0	13.85
0.1	5.75	1.1	7.23	2.1	9.45	3.1	11.71	4.1	14.10
0.2	5.82	1.2	7.44	2.2	9.68	3.2	11.94	4.2	14.36
0.3	5.91	1.3	7.66	2.3	9.90	3.3	12.17	4.3	14.62
0.4	6.02	1.4	7.88	2.4	10.13	3.4	12.40	4.4	14.89
0.5	6.15	1.5	8.10	2.5	10.35	3.5	12.64	4.5	15.16
0.6	6.30	1.6	8.32	2.6	10.58	3.6	12.87	4.6	15.43
0.7	6.47	1.7	8.55	2.7	10.81	3.7	13.11	4.7	15.71
0.8	6.65	1.8	8.77	2.8	11.03	3.8	13.36	4.8	16.00
0.9	6.83	1.9	9.00	2.9	11.26	3.9	13.60	4.9	16.28

Setting	Kvs m ³ /h	Setting	Kvs m ³ /h	Setting	Kvs m ³ /h	Setting	Kvs m ³ /h	Setting	Kvs m ³ /h
5.0	16.58	6.0	19.74	7.0	23.18	8.0	26.62	9.0	30.22
5.1	16.87	6.1	20.08	7.1	23.52	8.1	26.97	9.1	30.62
5.2	17.18	6.2	20.42	7.2	23.87	8.2	27.31	9.2	31.04
5.3	17.48	6.3	20.76	7.3	24.22	8.3	27.66	9.3	31.47
5.4	17.80	6.4	21.10	7.4	24.56	8.4	28.01	9.4	31.92
5.5	18.11	6.5	21.45	7.5	24.91	8.5	28.36	9.5	32.40
5.6	18.43	6.6	21.79	7.6	25.25	8.6	28.72	9.6	32.90
5.7	18.75	6.7	22.14	7.7	25.59	8.7	29.08	9.7	33.43
5.8	19.08	6.8	22.48	7.8	25.94	8.8	29.45	9.8	34.00
5.9	19.41	6.9	22.83	7.9	26.28	8.9	29.83	9.9	34.52

4. Product data sheet

4.5 Measuring signal diagrams



DN 10 - female/female

Setting	Kvm m ³ /h	Setting	Kvm m ³ /h	Setting	Kvm m ³ /h	Setting	Kvm m ³ /h	Setting	Kvm m ³ /h
0.0	0.065	1.0	0.144	2.0	0.226	3.0	0.306	4.0	0.383
0.1	0.073	1.1	0.152	2.1	0.234	3.1	0.314	4.1	0.390
0.2	0.081	1.2	0.161	2.2	0.242	3.2	0.322	4.2	0.397
0.3	0.089	1.3	0.169	2.3	0.250	3.3	0.330	4.3	0.404
0.4	0.097	1.4	0.177	2.4	0.258	3.4	0.338	4.4	0.411
0.5	0.105	1.5	0.185	2.5	0.266	3.5	0.346	4.5	0.418
0.6	0.112	1.6	0.193	2.6	0.274	3.6	0.361	4.6	0.425
0.7	0.120	1.7	0.201	2.7	0.282	3.7	0.368	4.7	0.432
0.8	0.128	1.8	0.209	2.8	0.290	3.8	0.368	4.8	0.438
0.9	0.136	1.9	0.217	2.9	0.298	3.9	0.376	4.9	0.445

Setting	Kvm m ³ /h	Setting	Kvm m ³ /h	Setting	Kvm m ³ /h	Setting	Kvm m ³ /h	Setting	Kvm m ³ /h
5.0	0.451	6.0	0.507	7.0	0.551	8.0	0.581	9.0	0.602
5.1	0.457	6.1	0.512	7.1	0.554	8.1	0.584	9.1	0.604
5.2	0.463	6.2	0.517	7.2	0.558	8.2	0.586	9.2	0.606
5.3	0.469	6.3	0.522	7.3	0.561	8.3	0.589	9.3	0.607
5.4	0.475	6.4	0.526	7.4	0.564	8.4	0.591	9.4	0.609
5.5	0.481	6.5	0.531	7.5	0.567	8.5	0.593	9.5	0.610
5.6	0.486	6.6	0.535	7.6	0.570	8.6	0.595	9.6	0.612
5.7	0.492	6.7	0.539	7.7	0.573	8.7	0.597	9.7	0.613
5.8	0.497	6.8	0.543	7.8	0.576	8.8	0.599	9.8	0.615
5.9	0.502	6.9	0.547	7.9	0.579	8.9	0.601	9.9	0.616

DN 15 - female/female

Setting	Kvm m ³ /h	Setting	Kvm m ³ /h	Setting	Kvm m ³ /h	Setting	Kvm m ³ /h	Setting	Kvm m ³ /h
0.0	0.06	1.0	0.11	2.0	0.25	3.0	0.39	4.0	0.54
0.1	0.06	1.1	0.12	2.1	0.26	3.1	0.41	4.1	0.56
0.2	0.06	1.2	0.13	2.2	0.28	3.2	0.42	4.2	0.57
0.3	0.06	1.3	0.15	2.3	0.29	3.3	0.44	4.3	0.59
0.4	0.07	1.4	0.16	2.4	0.31	3.4	0.45	4.4	0.61
0.5	0.07	1.5	0.17	2.5	0.32	3.5	0.47	4.5	0.62
0.6	0.08	1.6	0.19	2.6	0.34	3.6	0.48	4.6	0.64
0.7	0.08	1.7	0.20	2.7	0.35	3.7	0.50	4.7	0.65
0.8	0.09	1.8	0.22	2.8	0.37	3.8	0.51	4.8	0.67
0.9	0.10	1.9	0.23	2.9	0.38	3.9	0.53	4.9	0.69

Setting	Kvm m ³ /h	Setting	Kvm m ³ /h	Setting	Kvm m ³ /h	Setting	Kvm m ³ /h	Setting	Kvm m ³ /h
5.0	0.70	6.0	0.88	7.0	1.09	8.0	1.29	9.0	1.48
5.1	0.72	6.1	0.90	7.1	1.11	8.1	1.31	9.1	1.49
5.2	0.74	6.2	0.92	7.2	1.13	8.2	1.33	9.2	1.51
5.3	0.76	6.3	0.94	7.3	1.15	8.3	1.35	9.3	1.53
5.4	0.77	6.4	0.96	7.4	1.17	8.4	1.37	9.4	1.54
5.5	0.79	6.5	0.98	7.5	1.19	8.5	1.39	9.5	1.56
5.6	0.81	6.6	1.00	7.6	1.21	8.6	1.41	9.6	1.57
5.7	0.83	6.7	1.03	7.7	1.23	8.7	1.43	9.7	1.58
5.8	0.85	6.8	1.05	7.8	1.25	8.8	1.44	9.8	1.60
5.9	0.87	6.9	1.07	7.9	1.27	8.9	1.46	9.9	1.61

4. Product data sheet

DN 20 - female/female

Setting	Kvm m ³ /h	Setting	Kvm m ³ /h	Setting	Kvm m ³ /h	Setting	Kvm m ³ /h	Setting	Kvm m ³ /h
0.0	0.12	1.0	0.31	2.0	0.63	3.0	0.96	4.0	1.29
0.1	0.13	1.1	0.34	2.1	0.66	3.1	0.99	4.1	1.32
0.2	0.14	1.2	0.37	2.2	0.70	3.2	1.03	4.2	1.36
0.3	0.16	1.3	0.40	2.3	0.73	3.3	1.06	4.3	1.39
0.4	0.17	1.4	0.44	2.4	0.76	3.4	1.09	4.4	1.43
0.5	0.19	1.5	0.47	2.5	0.79	3.5	1.12	4.5	1.46
0.6	0.21	1.6	0.50	2.6	0.83	3.6	1.16	4.6	1.50
0.7	0.24	1.7	0.53	2.7	0.86	3.7	1.19	4.7	1.53
0.8	0.26	1.8	0.57	2.8	0.89	3.8	1.22	4.8	1.57
0.9	0.29	1.9	0.60	2.9	0.93	3.9	1.26	4.9	1.60

Setting	Kvm m ³ /h	Setting	Kvm m ³ /h	Setting	Kvm m ³ /h	Setting	Kvm m ³ /h	Setting	Kvm m ³ /h
5.0	1.64	6.0	2.03	7.0	2.46	8.0	2.96	9.0	3.53
5.1	1.67	6.1	2.07	7.1	2.51	8.1	3.02	9.1	3.60
5.2	1.71	6.2	2.11	7.2	2.56	8.2	3.07	9.2	3.66
5.3	1.75	6.3	2.15	7.3	2.61	8.3	3.13	9.3	3.72
5.4	1.79	6.4	2.19	7.4	2.66	8.4	3.18	9.4	3.79
5.5	1.83	6.5	2.24	7.5	2.71	8.5	3.24	9.5	3.86
5.6	1.86	6.6	2.28	7.6	2.76	8.6	3.29	9.6	3.93
5.7	1.90	6.7	2.33	7.7	2.81	8.7	3.35	9.7	4.00
5.8	1.94	6.8	2.37	7.8	2.86	8.8	3.41	9.8	4.07
5.9	1.98	6.9	2.42	7.9	2.91	8.9	3.47	9.9	4.15

DN 25 - female/female

Setting	Kvm m ³ /h	Setting	Kvm m ³ /h	Setting	Kvm m ³ /h	Setting	Kvm m ³ /h	Setting	Kvm m ³ /h
0.0	0.35	1.0	0.48	2.0	0.95	3.0	1.55	4.0	2.17
0.1	0.34	1.1	0.52	2.1	1.00	3.1	1.61	4.1	2.23
0.2	0.34	1.2	0.56	2.2	1.06	3.2	1.67	4.2	2.29
0.3	0.34	1.3	0.60	2.3	1.12	3.3	1.73	4.3	2.35
0.4	0.35	1.4	0.64	2.4	1.18	3.4	1.80	4.4	2.41
0.5	0.36	1.5	0.69	2.5	1.24	3.5	1.86	4.5	2.47
0.6	0.38	1.6	0.73	2.6	1.30	3.6	1.92	4.6	2.53
0.7	0.40	1.7	0.79	2.7	1.36	3.7	1.98	4.7	2.59
0.8	0.42	1.8	0.84	2.8	1.42	3.8	2.04	4.8	2.65
0.9	0.45	1.9	0.89	2.9	1.49	3.9	2.10	4.9	2.71

Setting	Kvm m ³ /h	Setting	Kvm m ³ /h	Setting	Kvm m ³ /h	Setting	Kvm m ³ /h	Setting	Kvm m ³ /h
5.0	2.78	6.0	3.45	7.0	4.29	8.0	5.31	9.0	6.30
5.1	2.84	6.1	3.53	7.1	4.39	8.1	5.42	9.1	6.38
5.2	2.90	6.2	3.61	7.2	4.48	8.2	5.52	9.2	6.45
5.3	2.97	6.3	3.69	7.3	4.58	8.3	5.63	9.3	6.51
5.4	3.03	6.4	3.77	7.4	4.68	8.4	5.73	9.4	6.57
5.5	3.10	6.5	3.85	7.5	4.79	8.5	5.84	9.5	6.61
5.6	3.17	6.6	3.93	7.6	4.89	8.6	5.94	9.6	6.64
5.7	3.24	6.7	4.02	7.7	4.99	8.7	6.03	9.7	6.66
5.8	3.31	6.8	4.11	7.8	5.10	8.8	6.13	9.8	6.66
5.9	3.38	6.9	4.20	7.9	5.21	8.9	6.22	9.9	6.66

4. Product data sheet

DN 32 - female/female

Setting	Kvm m ³ /h	Setting	Kvm m ³ /h	Setting	Kvm m ³ /h	Setting	Kvm m ³ /h	Setting	Kvm m ³ /h
0.0	1.81	1.0	2.42	2.0	3.21	3.0	4.06	4.0	5.00
0.1	1.85	1.1	2.49	2.1	3.29	3.1	4.15	4.1	5.10
0.2	1.90	1.2	2.57	2.2	3.37	3.2	4.24	4.2	5.20
0.3	1.96	1.3	2.64	2.3	3.46	3.3	4.33	4.3	5.30
0.4	2.02	1.4	2.72	2.4	3.54	3.4	4.42	4.4	5.40
0.5	2.08	1.5	2.80	2.5	3.63	3.5	4.51	4.5	5.50
0.6	2.14	1.6	2.88	2.6	3.71	3.6	4.61	4.6	5.60
0.7	2.21	1.7	2.96	2.7	3.80	3.7	4.70	4.7	5.70
0.8	2.28	1.8	3.04	2.8	3.89	3.8	4.79	4.8	5.80
0.9	2.35	1.9	3.12	2.9	3.97	3.9	4.89	4.9	5.90

Setting	Kvm m ³ /h	Setting	Kvm m ³ /h	Setting	Kvm m ³ /h	Setting	Kvm m ³ /h	Setting	Kvm m ³ /h
5.0	6.00	6.0	7.10	7.0	8.30	8.0	9.50	9.0	10.8
5.1	6.10	6.1	7.20	7.1	8.40	8.1	9.60	9.1	10.9
5.2	6.20	6.2	7.30	7.2	8.50	8.2	9.70	9.2	11.0
5.3	6.30	6.3	7.50	7.3	8.60	8.3	9.90	9.3	11.1
5.4	6.40	6.4	7.60	7.4	8.80	8.4	10.0	9.4	11.3
5.5	6.50	6.5	7.70	7.5	8.90	8.5	10.1	9.5	11.4
5.6	6.70	6.6	7.80	7.6	9.00	8.6	10.2	9.6	11.6
5.7	6.80	6.7	7.90	7.7	9.10	8.7	10.4	9.7	11.7
5.8	6.90	6.8	8.00	7.8	9.30	8.8	10.5	9.8	11.9
5.9	7.00	6.9	8.20	7.9	9.40	8.9	10.6	9.9	12.0

DN 40 - female/female

Setting	Kvm m ³ /h	Setting	Kvm m ³ /h	Setting	Kvm m ³ /h	Setting	Kvm m ³ /h	Setting	Kvm m ³ /h
0.0	2.61	1.0	3.50	2.0	4.90	3.0	6.40	4.0	8.00
0.1	2.68	1.1	3.60	2.1	5.00	3.1	6.60	4.1	8.20
0.2	2.75	1.2	3.80	2.2	5.20	3.2	6.70	4.2	8.30
0.3	2.83	1.3	3.90	2.3	5.30	3.3	6.90	4.3	8.50
0.4	2.92	1.4	4.00	2.4	5.50	3.4	7.00	4.4	8.70
0.5	3.01	1.5	4.20	2.5	5.60	3.5	7.20	4.5	8.80
0.6	3.10	1.6	4.30	2.6	5.80	3.6	7.40	4.6	9.00
0.7	3.20	1.7	4.40	2.7	5.90	3.7	7.50	4.7	9.20
0.8	3.31	1.8	4.60	2.8	6.10	3.8	7.70	4.8	9.30
0.9	3.42	1.9	4.70	2.9	6.20	3.9	7.80	4.9	9.50

Setting	Kvm m ³ /h	Setting	Kvm m ³ /h	Setting	Kvm m ³ /h	Setting	Kvm m ³ /h	Setting	Kvm m ³ /h
5.0	9.70	6.0	11.4	7.0	13.3	8.0	15.5	9.0	18.0
5.1	9.80	6.1	11.5	7.1	13.5	8.1	15.7	9.1	18.3
5.2	10.0	6.2	11.7	7.2	13.7	8.2	15.9	9.2	18.6
5.3	10.2	6.3	11.9	7.3	13.9	8.3	16.2	9.3	18.9
5.4	10.3	6.4	12.1	7.4	14.1	8.4	16.4	9.4	19.1
5.5	10.5	6.5	12.3	7.5	14.3	8.5	16.7	9.5	19.4
5.6	10.7	6.6	12.5	7.6	14.5	8.6	17.0	9.6	19.7
5.7	10.8	6.7	12.7	7.7	14.8	8.7	17.2	9.7	20.0
5.8	11.0	6.8	12.9	7.8	15.0	8.8	17.5	9.8	20.3
5.9	11.2	6.9	13.1	7.9	15.2	8.9	17.8	9.9	20.6

4. Product data sheet

DN 50 - female/female

Setting	Kvm m ³ /h	Setting	Kvm m ³ /h	Setting	Kvm m ³ /h	Setting	Kvm m ³ /h	Setting	Kvm m ³ /h
0.0	5.5	1.0	6.9	2.0	8.9	3.0	11.1	4.0	13.3
0.1	5.6	1.1	7.1	2.1	9.2	3.1	11.3	4.1	13.5
0.2	5.7	1.2	7.3	2.2	9.4	3.2	11.5	4.2	13.8
0.3	5.8	1.3	7.5	2.3	9.6	3.3	11.7	4.3	14.0
0.4	5.9	1.4	7.7	2.4	9.8	3.4	12.0	4.4	14.2
0.5	6.1	1.5	7.9	2.5	10.0	3.5	12.2	4.5	14.5
0.6	6.2	1.6	8.1	2.6	10.2	3.6	12.4	4.6	14.7
0.7	6.4	1.7	8.3	2.7	10.4	3.7	12.6	4.7	14.9
0.8	6.6	1.8	8.5	2.8	10.7	3.8	12.9	4.8	15.2
0.9	6.7	1.9	8.7	2.9	10.9	3.9	13.1	4.9	15.4

Setting	Kvm m ³ /h	Setting	Kvm m ³ /h	Setting	Kvm m ³ /h	Setting	Kvm m ³ /h	Setting	Kvm m ³ /h
5.0	15.7	6.0	18.2	7.0	20.9	8.0	23.6	9.0	26.4
5.1	15.9	6.1	18.5	7.1	21.2	8.1	23.9	9.1	26.8
5.2	16.2	6.2	18.7	7.2	21.4	8.2	24.2	9.2	27.1
5.3	16.4	6.3	19.0	7.3	21.7	8.3	24.4	9.3	27.4
5.4	16.7	6.4	19.3	7.4	22.0	8.4	24.7	9.4	27.7
5.5	16.9	6.5	19.5	7.5	22.2	8.5	25.0	9.5	28.1
5.6	17.2	6.6	19.8	7.6	22.5	8.6	25.3	9.6	28.4
5.7	17.4	6.7	20.1	7.7	22.8	8.7	25.6	9.7	28.8
5.8	17.7	6.8	20.3	7.8	23.1	8.8	25.8	9.8	29.2
5.9	17.9	6.9	20.6	7.9	23.3	8.9	26.1	9.9	29.6

4.6 Measuring accuracy

The measuring accuracy of NexusValve Vertex is variable and depends on the valve setting. A high valve setting position provides a more accurate measuring.

DN 10 - female/female

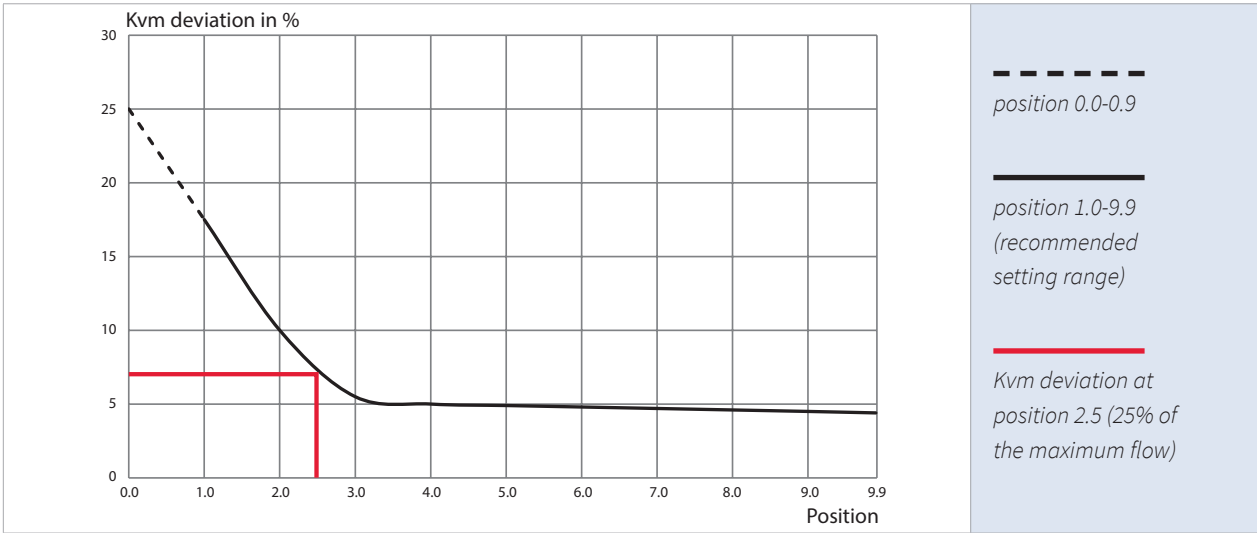

The NexusValve Vertex DN 10 conforms to the BS standard 7350:1990. At 25% of the flow range the Kvm deviation is only $\pm 7\%$.

DN 15 - female/female

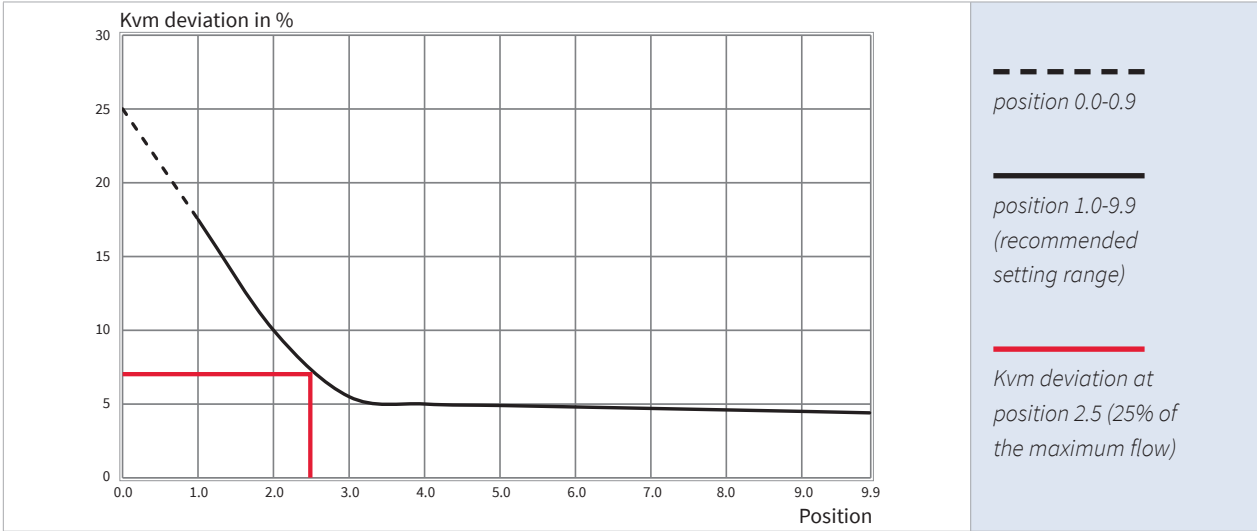

The NexusValve Vertex DN 15 conforms to the BS standard 7350:1990. At 25% of the flow range the Kvm deviation is only $\pm 7\%$.

4. Product data sheet

DN 20 - female/female

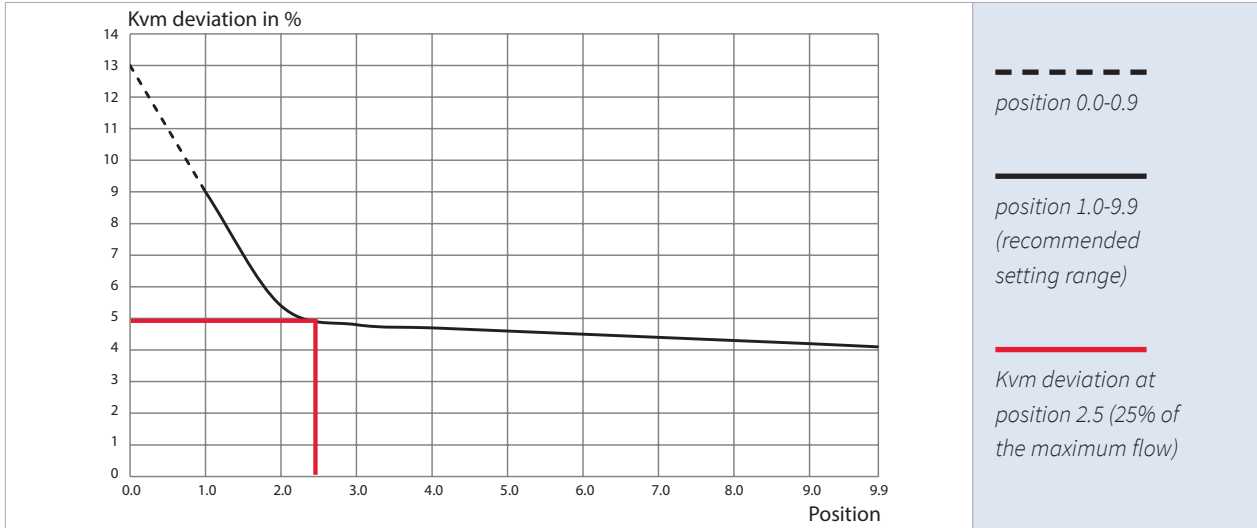

The NexusValve Vertex DN 20 conforms to the BS standard 7350:1990. At 25% of the flow range the Kvm deviation is only $\pm 5\%$.

DN 25 - female/female

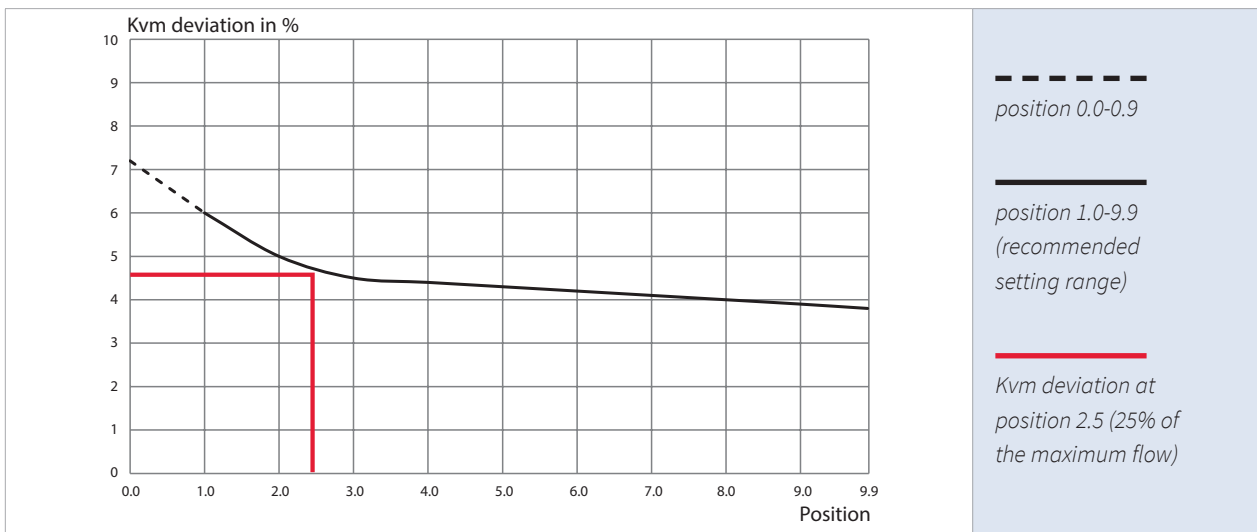

The NexusValve Vertex DN 25 conforms to the BS standard 7350:1990. At 25% of the flow range the Kvm deviation is only $\pm 4.5\%$.

DN 32 - female/female

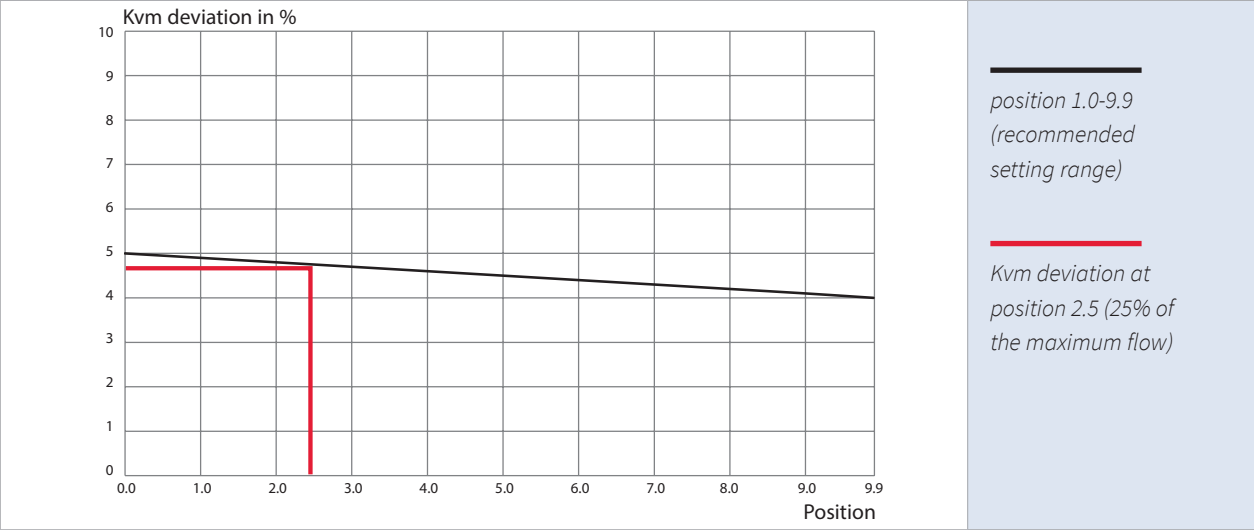

The NexusValve Vertex DN 32 conforms to the BS standard 7350:1990. At 25% of the flow range the Kvm deviation is only $\pm 4.7\%$.

DN 40 - female/female

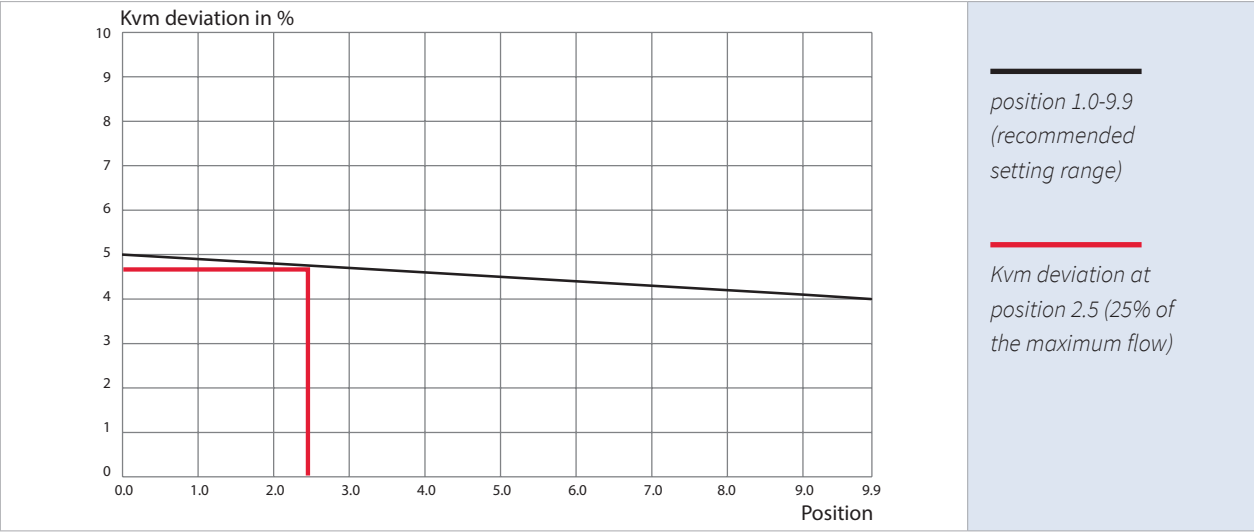

The NexusValve Vertex DN 40 conforms to the BS standard 7350:1990. At 25% of the flow range the Kvm deviation is only $\pm 4.7\%$.

4. Product data sheet

DN 50 - female/female

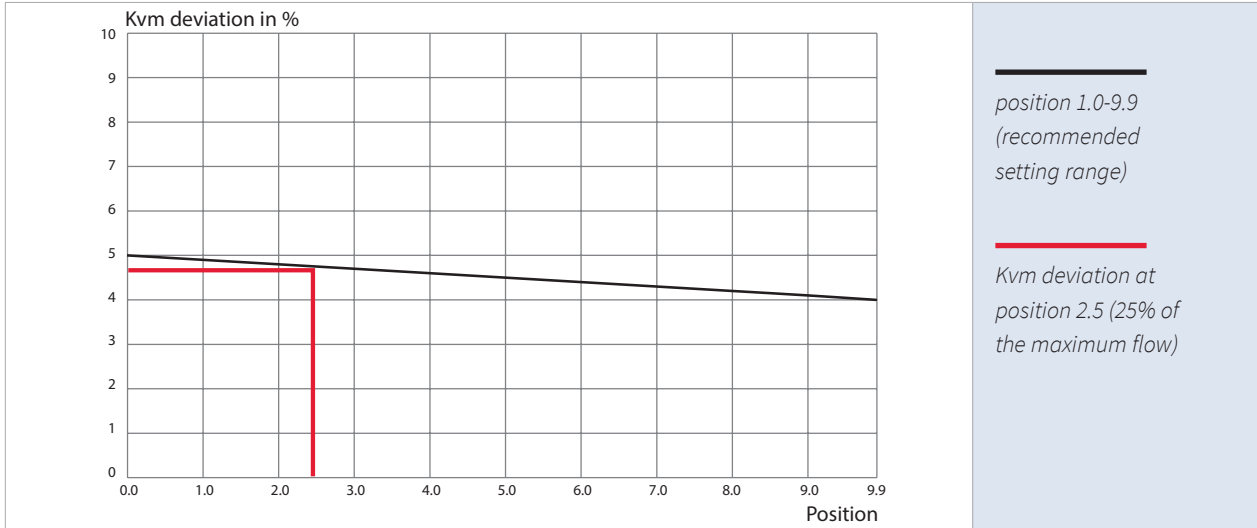

The NexusValve Vertex DN 50 conforms to the BS standard 7350:1990. At 25% of the flow range the Kvm deviation is only $\pm 4.7\%$.

Note! The measuring accuracy is not affected by the flow direction through the NexusValve Vertex valve.

5. Accessories

There is a wide range of accessories and spare parts available for NexusValve Vertex valves.
These comprise: insulation jackets, press adaptors, high capacity drain valve and other

Accessories	Article	Dimension	Description
	MN80597.7000	DN 15	Insulation jackets for NexusValve Vertex Material: expanded polypropylene Color: anthracite Thermal conductivity: 0,035 W/mK at 10°C Application: up to 110°C Fire protection class: B2, DIN 4102 and E, EN 13501-1
	MN80597.7010	DN 20	
	MN80597.7020	DN 25	
	MN80597.7030	DN 32	
	MN80597.7040	DN 40	
	MN80597.7050	DN 50	
	MN80597.0001	15 mm x 1/2"	Pre-sealed press adaptors (2 pcs) for valve DN 15 -50, max. 16 bar
	MN80597.0002	18 mm x 1/2"	
	MN80597.0003	15 mm x 3/4"	
	MN80597.0004	18 mm x 3/4"	
	MN80597.0005	22 mm x 3/4"	
	MN80597.0006	28 mm x 1"	
	MN80597.0007	35 mm x 1 1/4"	
	MN80597.0008	42 mm x 1 1/2"	
	MN80597.0009	54 mm x 2"	
	MN80597.0205	DN 15	High capacity drain valve (Kv 4,5) 1/2" female/female threaded connection
	MN80597.0206	DN 20	High capacity drain valve (Kv 4,5) 3/4" female/female threaded connection
	MN80597.0207	DN 25	High capacity drain valve (Kv 4,5) 1" female/female threaded connection

6. Sizing example

6.1 NexusValve Vertex system sizing

The following sizing example shows NexusValve Vertex installed in a system of fan coils. The NexusValve Vertex provides the required flow in the branch, and the motorized valves, connected to a BMS system or room thermostats, control the indoor air temperature.

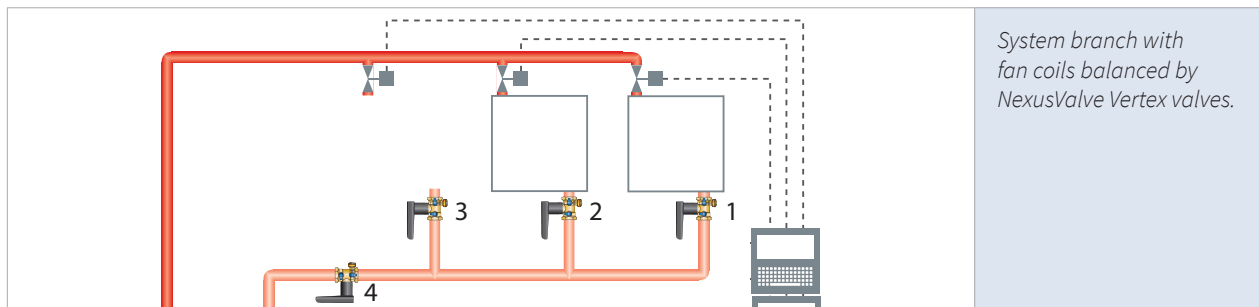

The flow to each fan coil is specified for the sizing conditions:

- NexusValve Vertex No. 1: required flow 0.07 l/s (252 l/h)
- NexusValve Vertex No. 2: required flow 0.20 l/s (720 l/h)
- NexusValve Vertex No. 3: required flow 0.25 l/s (900 l/h)
- NexusValve Vertex No. 4: required flow 0.52 l/s (1872 l/h)

The pressure losses have been calculated in the pipes, across the fully open motorized valves and fan coils. Based on the results the following pressure losses across the NexusValve Vertex valves must be provided:

- NexusValve Vertex No. 1: required pressure loss 3.0 kPa
- NexusValve Vertex No. 2: required pressure loss 7.0 kPa
- NexusValve Vertex No. 3: required pressure loss 10.0 kPa
- NexusValve Vertex No. 4: required pressure loss 20.0 kPa

The required valve authority and thus good regulation ability are achieved, when valves are sized to meet the required flow and pressure loss, at fully or nearly fully open position.

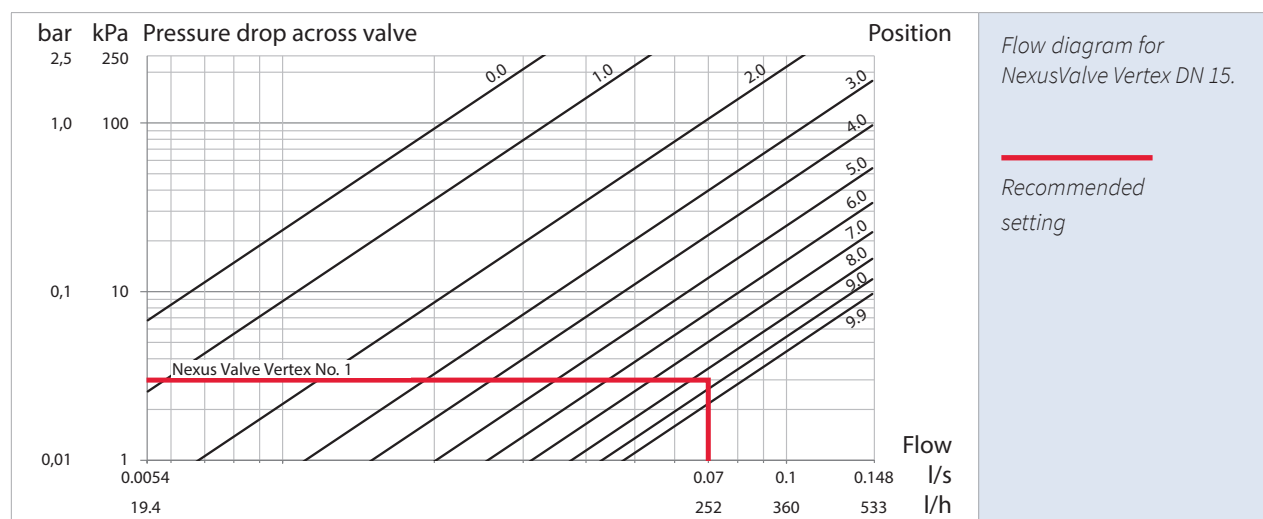

The smallest size NexusValve Vertex meeting the requirements is selected for each system circuit. In this case a DN 15 valve at setting 8.5 will reach the required flow of 0.07 l/s and the required pressure loss of 3.0 kPa. This valve size will provide good regulation as any setting change will result in a greater pressure loss than for example in the case of a DN 20 valve. It is therefore easier to adjust a DN 15 valve than a DN 20 valve to the desired flow (see the next graph at the end of this page).

The NexusValve Vertex DN 15 setting range for 0.7 l/s flow is 9.9 - 1.4 = 8.5

The NexusValve Vertex DN 20 setting range for 0.7 l/s flow is 6.8 - 1.0 = 5.8

The DN 15 valve is preferred as it is easier to set the valve to the required flow compared to the DN 20 valve due to the higher setting resolution.

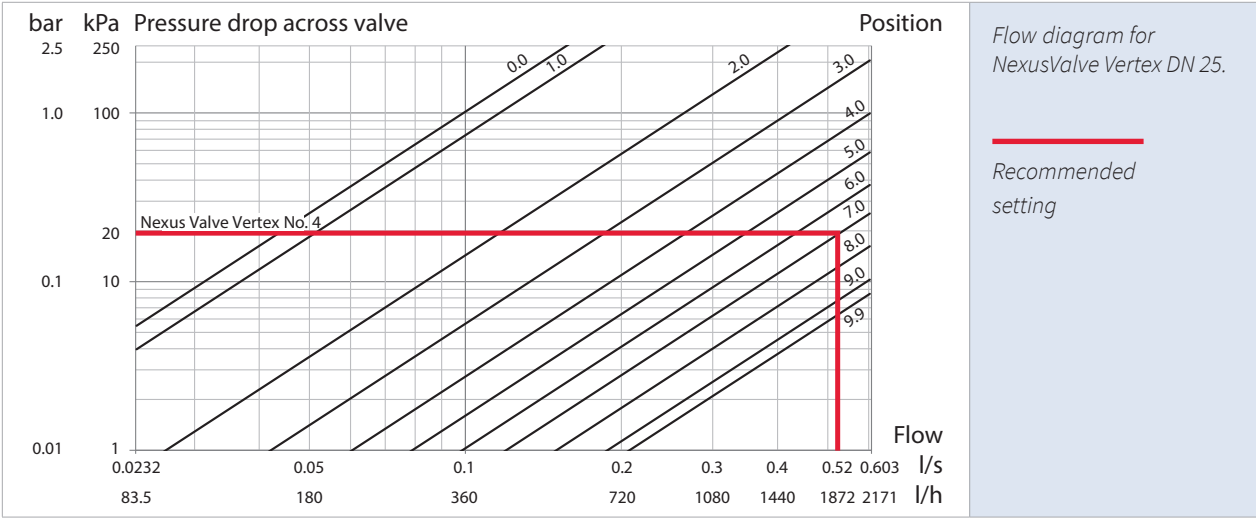
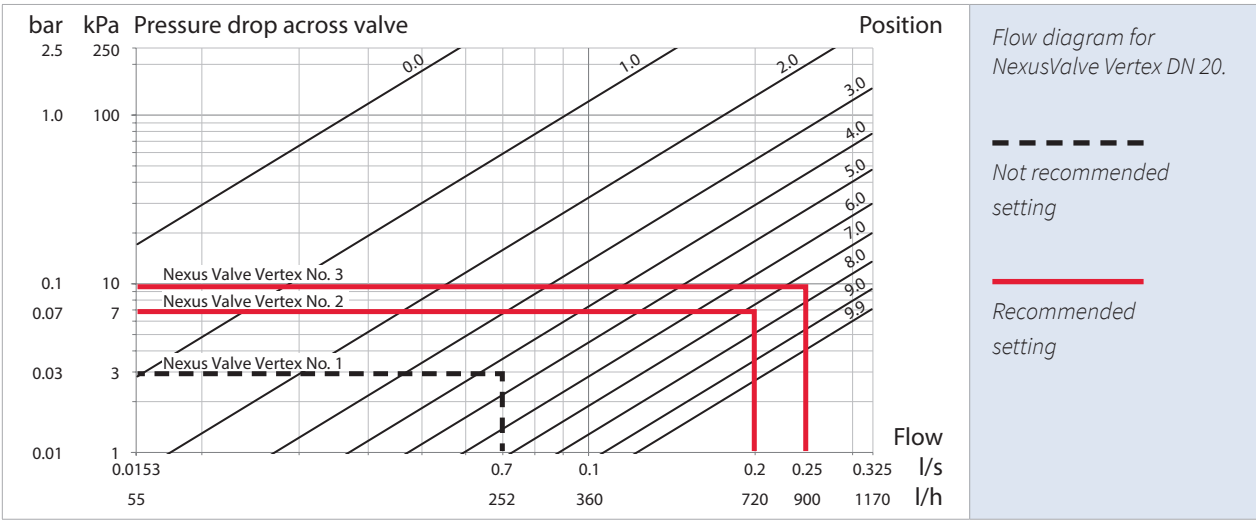

For the 0.20 l/s and 0.25 l/s flow NexusValve Vertex DN 20 is selected and for the 0.52 l/s flow NexusValve Vertex DN 25 is selected.

6. Sizing example

The valves are set at:

NexusValve Vertex No. 1: DN 15, setting 8.5

NexusValve Vertex No. 2: DN 20, setting 7.2

NexusValve Vertex No. 3: DN 20, setting 7.4

NexusValve Vertex No. 4: DN 25, setting 6.9

Ordering:

NexusValve Vertex No. 1 Article No.: MN80597.700

NexusValve Vertex No. 2, 3 Article No.: MN80597.701

NexusValve Vertex No. 4 Article No.: MN80597.702

6.2 General specifications DN 10-50

1 Balancing valve DN 10 - 50

1.1. The Contractor must install static balancing valves where indicated in drawings.

2. Valve Body

- 2.1. The valve body must be made of hot stamped DR brass CW602N CuZn36Pb2As.
- 2.2. The pressure rating must be no less than PN25 (PN16 with press adaptors).
- 2.3. The valve must be able to perform regulation, isolation and flow measurement in one single unit.
- 2.4. The valve must be bi-directional to flow, and no flow arrow must be indicated in the valve body.
- 2.5. The handle and the P/T ports must be perpendicular to each other.
- 2.6. Testing through measuring points must be possible in all valve positions.
- 2.7. One measuring point must be installed in front of the isolation ball and the other behind the isolation ball.
- 2.8. The size of the valve must be clearly marked on the handle.

3. Flow Regulation

- 3.1. The flow setting must be externally adjustable by means of an Allen key.
- 3.2. The flow setting must remain unchanged when the isolation (open/close) function is operated.
- 3.3. Flow measurement must be done across a ball with a built-in regulating needle.

4. Functions

- 4.1. The valve must have a visible quarter-turn open/close function.
- 4.2. The valve must have scale of 100 different setting positions at an 0.1 increment.
- 4.3. Flow through the valve must be possible in both directions at the same Kv-value.

Contact

Contact data

www.flamcogroup.com

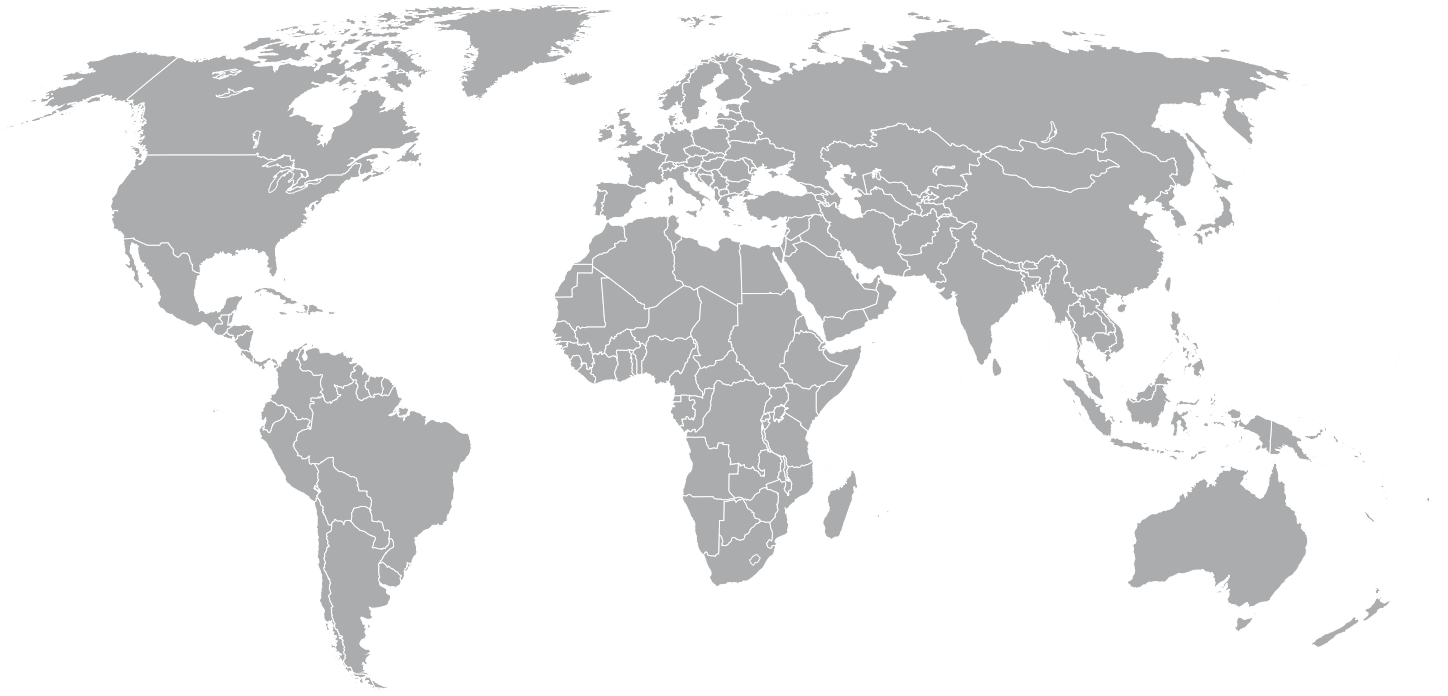

www.flamcogroup.com

the Netherlands

Flamco B.V.
PO Box 502
3750 GM Bunschoten
Amersfoortseweg 9
3751 LJ Bunschoten

T +31 (0)33 299 75 00
E info@flamco.nl
I www.flamcogroup.com

United Kingdom

Flamco UK Ltd
Washway Lane
St Helens, Merseyside
WA10 6PB

T +44 1744 744 744
F +44 1744 744 700
E info@flamco.co.uk
I www.flamcogroup.com

United Arab Emirates

Flamco Middle East
PO Box 262636
Jebel Ali
Dubai

T +971 4 881 95 40
F +971 4 881 95 60
E info@flamco-gulf.com
I www.flamcogroup.com

Subject to modifications

24002.017 Valid since 28-02-2019