

Static Balancing Valves

Nexus Valve
Fluctus

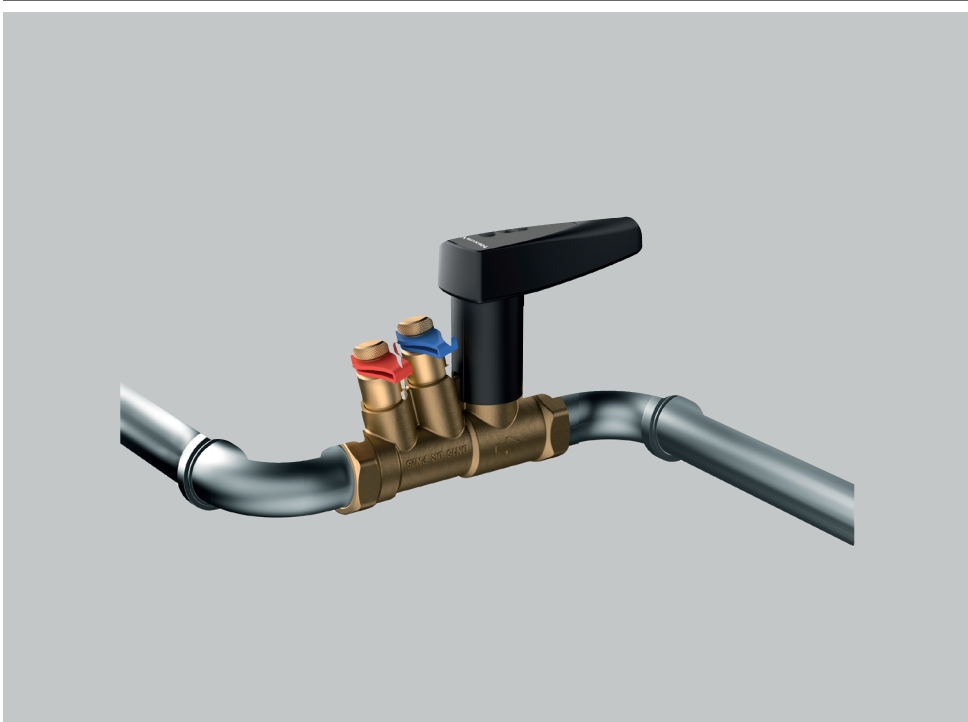

Table of contents

Chapter NexusValve Fluctus DN 15-50 / DN 65-600

1.	Safety instructions	4
1.1	Rules/regulations	4
1.2	Intended use	5
1.3	Initial operation	5
1.4	Working on the system	5
1.5	Liability	5
2.	Introduction	6
2.1	Description	6
2.2	Benefits	6
2.3	Design	7
2.4	Venturi nozzle principle	9
2.5	Measuring accuracy	10
2.6	Mounting	10
2.7	Flow balancing	11
2.8	Operation	11
3.	Applications	13
4.	Product data sheet	17
4.1	Product finder	17
4.2	NexusValve Fluctus DN 15-50	19
4.2.1	DN 15-50 female/female	19
4.2.2	With drain – DN 15-50 female/female	21
4.2.3	DN 15 compression/compression	23
4.2.4	DN 15-50 flange/flange	25
4.3	NexusValve Fluctus DN 65-600 flange/flange	27
4.4	Flow diagrams	30
4.5	Measuring signal diagrams	40
5.	Accessories	49
6.	Sizing examples	50
6.1	NexusValve Fluctus system sizing	50
6.2	Calculation of flow rates higher than specified in the diagrams	52
6.3	General specifications DN 15 - 50	53
6.4	General specifications DN 65 - 600	53

1. Safety instructions

Please read the instructions carefully before installation

The installation and initial operation of the assembly may be carried out only by an authorised specialist company. Prior to starting work, familiarise yourself with all parts and how they are handled. The application examples in these operating instructions are ideas sketched out. Local laws and regulations have to be observed.

Target group:

These instructions are intended for authorised specialists exclusively. Work on the heating system, the potable water as well as gas and power network may be carried out by specialists only.



Please follow these safety instructions carefully in order to avoid hazards and damage to people and property.

1.1 Rules/regulations

Please observe the applicable accident prevention regulations, the environmental legislation and the legal rules for mounting, installation and operation. Moreover, please observe the appropriate guidelines of German standard DIN, EN, DVGW, VDI and VDE (including lightning protection) as well as all current relevant country-specific standards, laws and regulations. Old and newly enforced regulations and standards shall apply, if they are relevant for the individual case. Moreover, the regulations of your local energy supply company have to be observed.

Electrical connection:

Electrical wiring work may be carried out by qualified electricians only. The VDE regulations and the specifications of the relevant energy supply company have to be met.

Excerpt:

Installation and construction of heat generators as well as the drinking water heaters:

DIN EN 4753, Part 1: Water heater and water heating plants for potable and process water.
DIN EN 12828 Heating systems in buildings.
DIN 18 421: Insulation work on technical plants
AV B Wa s V Regulations concerning the general conditions for the supply with water
DIN EN 806 ff.: Technical rules for potable water installation
DIN 1988 ff.: Technical rules for potable water installation (national addition)
DIN EN 1717: Protection of potable water against contaminations
DIN 4751: Safety equipment

Electrical connection:

VDE 0100: Erection of electrical equipment, grounding, protective conductor, potential equalisation conductor.
VDE 0701: Repair, modification and testing of electrical devices.
VDE 0185: General aspects on the erection of lightning protection systems.
VDE 0190: Main potential equalisation of electrical plants.
VDE 0855: Installation of antenna plants (shall apply mutatis mutandis).

Additional remarks:

VDI 6002 Sheet 1: General principles, system technology and use in house building

VDI 6002, Sheet 2: Use in students' hostels, retirement homes, hospitals, indoor swimming pools and on camping facilities

Caution:

Prior to any electrical wiring work on pumps and controls, these modules have to be disconnected from voltage correctly.

1.2 Intended use

Inexpert installation as well as use for a purpose not intended of the assembly shall rule out all warranty claims.

All shut-off valves may be closed by an approved specialist only in case of servicing as otherwise the safety valves are not effective.



Do not modify the electrical components, the construction or the hydraulic components! You will impair the safe function of the plant otherwise.

1.3 Initial operation

Prior to the initial operation, the plant has to be tested for tightness, correct hydraulic connection as well as accurate and correct electrical connection. In addition, the plant has to be flushed correctly and/as required in keeping with German standard DIN 4753. The initial operation has to be carried out by a trained specialist, which has to be recorded in writing. In addition, the settings have to be put down in writing.

The technical documentation has to be available at the device.

1.4 Working on the system

The plant has to be de-energised and to be checked for the absence of voltage (such as on the separate fuse or a master switch). Secure the plant against unintentional restart.

(If gas is used as fuel, close the gas shut-off valve and secure against unintentional opening.) Repair work on component parts with a safety-relevant function is impermissible.

1.5 Liability

We reserve all copyrights for this document. Wrongful use, in particular reproduction and forwarding to third parties shall not be permitted.

These installation and operating instructions shall have to be handed to the customer. The executing and/or authorised tradesperson (such as fitter) shall have to explain the function and operation of the plant to the customer in an intelligible manner.

2. Introduction

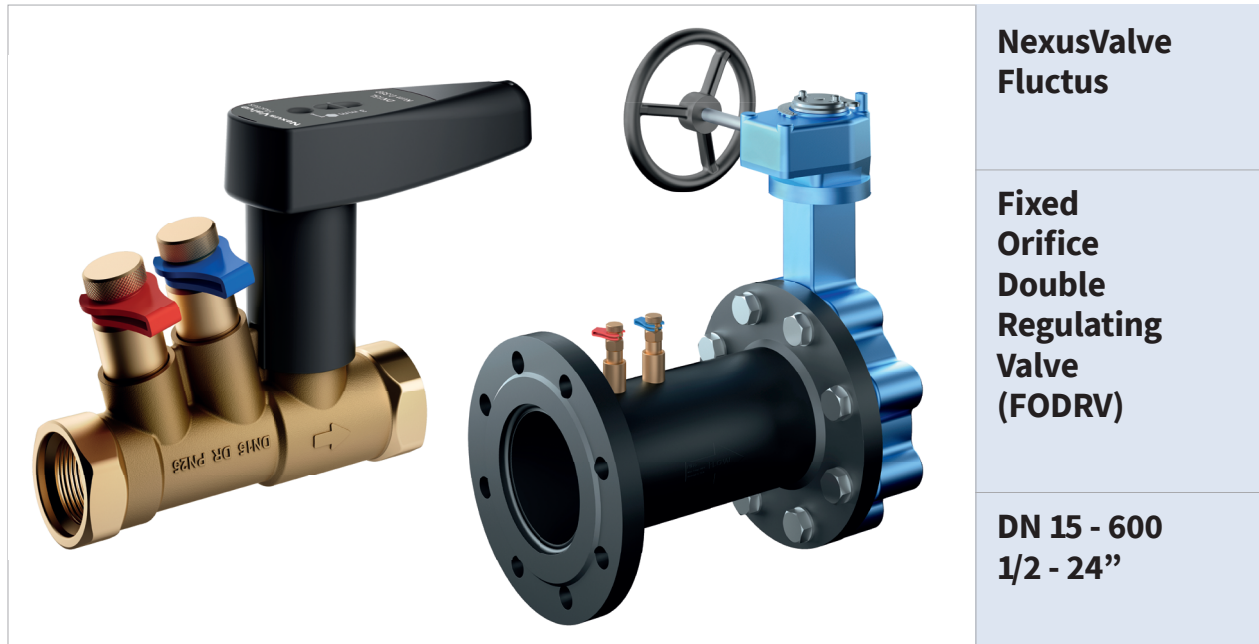

2.1 Description

The NexusValve Fluctus is a range of manual balancing valves used in water-based heating and cooling systems to ensure an evenly distributed flow in zones, branches, risers and terminal units. Applications are typically central, district heating or cooling systems as well as fan coil units in multi-storey and high-rise buildings.

The NexusValve Fluctus valve is compact having flow measuring, regulation and isolation functions all in one unit. The range consists of valves in sizes DN 15 - 50, manufactured in dezincification resistant brass (DR), to valves in sizes DN 65 - 600, manufactured in steel and cast iron.

The NexusValve Fluctus has a built-in Venturi nozzle for accurate measuring. This design provides the NexusValve Fluctus with consistent measuring accuracy tolerances within $\pm 3\%$, and the NexusValve Fluctus is more accurate than variable orifice double regulating valves.

Because of the higher accuracy and low pressure loss, the NexusValve Fluctus is more efficient for reduced energy consumption when heating and cooling systems are balanced.

2.2 Benefits

Valves DN 15 - 600:

- Extensive product range from DN 15 - 600
- Constant measuring accuracy tolerances within $\pm 3\%$
- Flow verification insensitive to system debris
- One constant Kvm value indicated on valve
- Simultaneous measuring and regulation

Valves DN 15 - 50:

- » Fast and easy setting using an Allen key
- » Setting scale precise and easy to read
- » No change in setting when isolated and reopened
- » Isolation simply done by a quarter turn of the valve handle
- » Easy identification of open or isolated position
- » No need for straight piping when installed
- » Installation directly onto bends, reducers and flexible hoses
- » Installation possible in all positions
- » Prefabricated insulation fast and easy to apply
- » Insulation possible before commissioning

2.3 Design

The pre-setting of NexusValve Fluctus DN 15 - 50 is done by setting the regulating needle which operates independently of the shut-off function. In that way the valve setting is kept intact when the valve is isolated and re-opened.

The differential pressure is measured for flow verification across the built-in Venturi nozzle having a constant Kvm value. The Kvm value of NexusValve Fluctus only has to be entered once in the flowmeter during system commissioning.

In comparison the Kv value of variable orifice double regulating valves is changed every time the setting is altered.

The new setting is in this case read from the handle scale and entered in the flowmeter every time a new flow has to be measured.

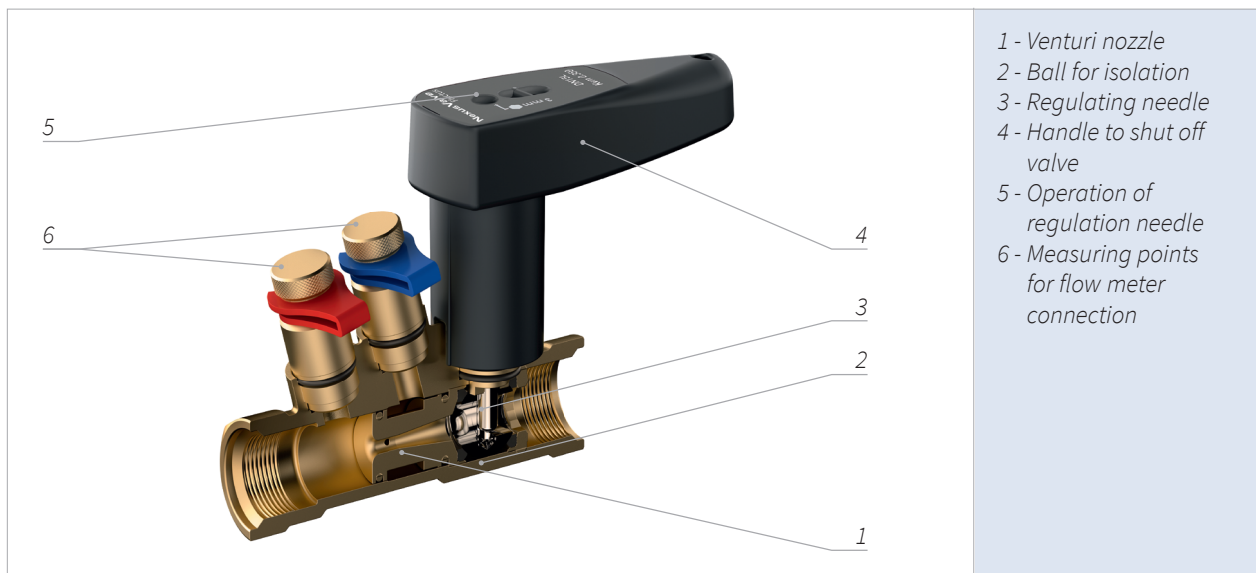

2. Introduction

The pre-setting of the NexusValve Fluctus DN 65 - 600 is done by setting the butterfly valve to the required position. The butterfly valve is fitted with a Venturi nozzle. Similarly to the NexusValve Fluctus DN 15 - 50 the differential pressure is measured across the Venturi nozzle where the Kvm value is constant and not affected when the setting is changed.

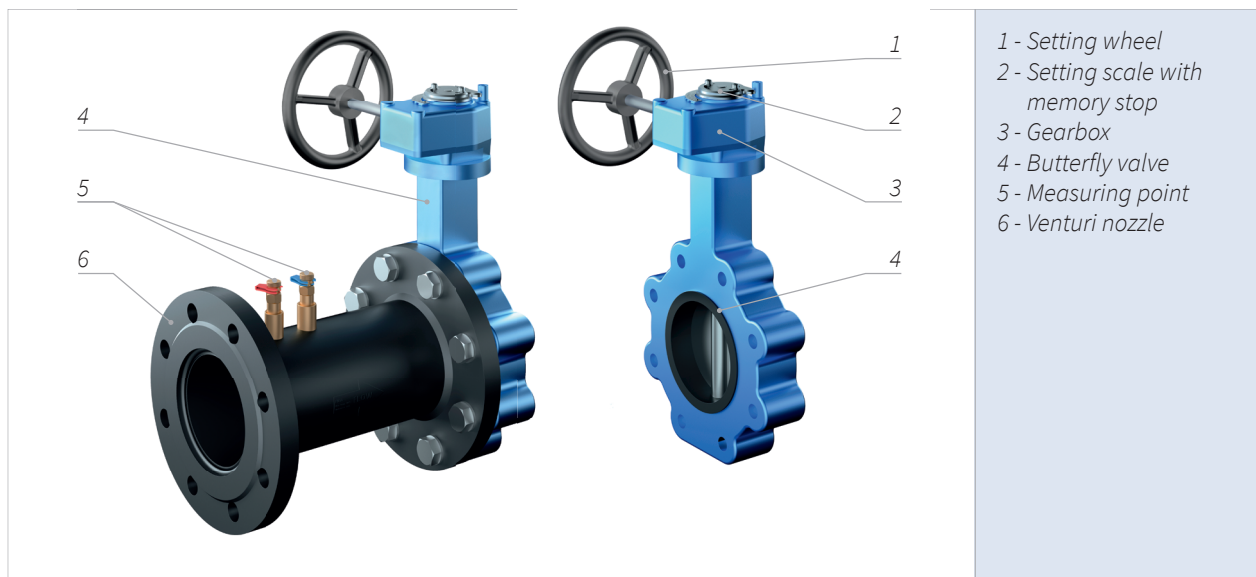

The butterfly valve is provided with a gearbox with memory stop. When the required setting of the valve is achieved, the memory stop is locked and the setting is fixed. The NexusValve Fluctus valves are optionally provided with a drain valve. The drain can be rotated 360° at any time, which proves to be particularly useful during the servicing of the system. The drain can also be used to connect a capillary tube from the NexusValve Passim differential pressure control valve. Such a valve combination ensures constant differential pressure and maximum flow limitation in the controlled part of the system.

There are two different drain types for the NexusValve Fluctus range. The valves DN 15 - 50 use Combi Drain Midi and the NexusValve Fluctus DN 65 - 600 use Combi Drain Maxi.



2.4 Venturi nozzle principle

The integrated Venturi nozzle enables direct flow measuring across the NexusValve Fluctus valve. The direct flow measurement allows a precise valve setting and easy trouble shooting. The Venturi nozzle exploits Bernoulli's principle stating that fluid speeds up as it moves through a constricted space; as the speed of the fluid increases, its pressure drops.

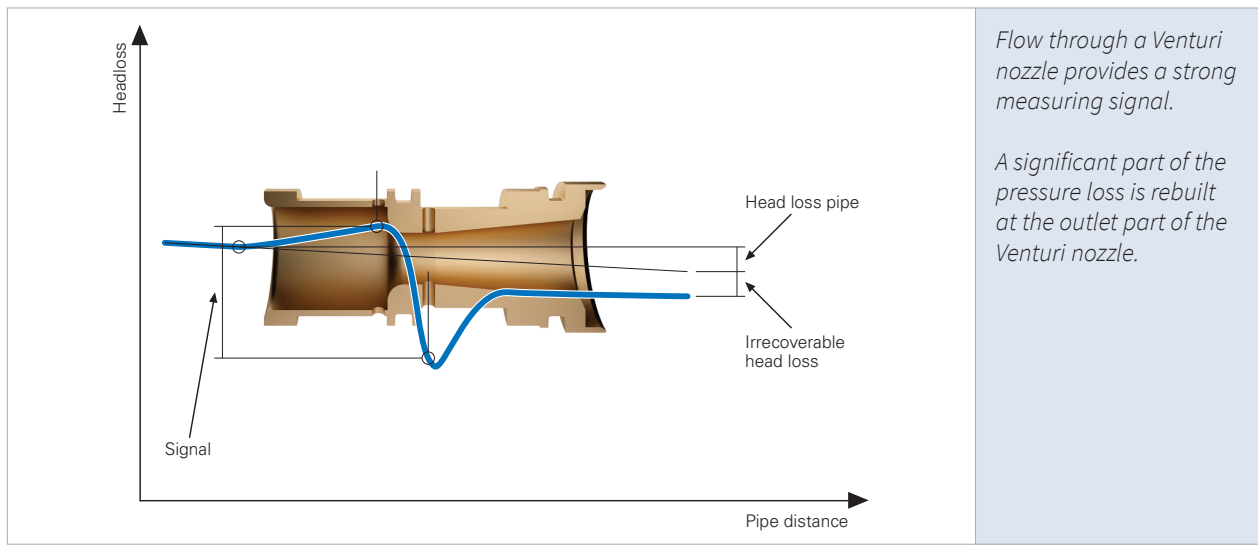

The differential pressure across the Venturi nozzle is measured where the pressure is at its highest and lowest. The trumpet shape of the NexusValve Venturi nozzle recovers a substantial part of the pressure, providing a strong measuring signal at a low total pressure drop.

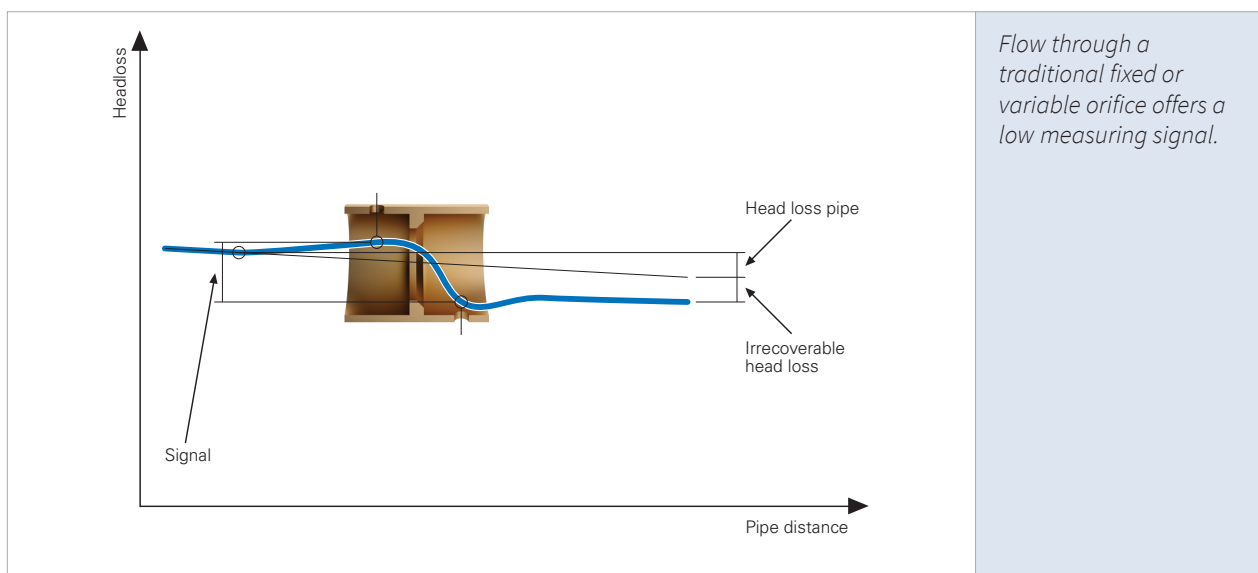

Compared to a standard variable orifice double regulating valve the Venturi nozzle provides a 10 times stronger signal at the same pressure drop. The measuring accuracy thereby becomes significantly greater.

2. Introduction

2.5 Measuring accuracy

Changing the valve setting does not affect the direct flow measurement as the Kvm value of the Venturi nozzle, between the measuring points, remains constant.

Using a flowmeter the NexusValve Fluctus Kvm value is entered only once to achieve the flow reading. If the valve setting is changed, the new flow will be displayed directly since the Kvm value remains constant and only the differential pressure changes.

The NexusValve Fluctus as a fixed orifice double regulating valve has consistent measuring accuracy within $\pm 3\%$ in the whole setting range of the valve. This feature is an important asset of the NexusValve Fluctus compared to variable orifice double regulating valves where accuracy is reduced as the valve closes.

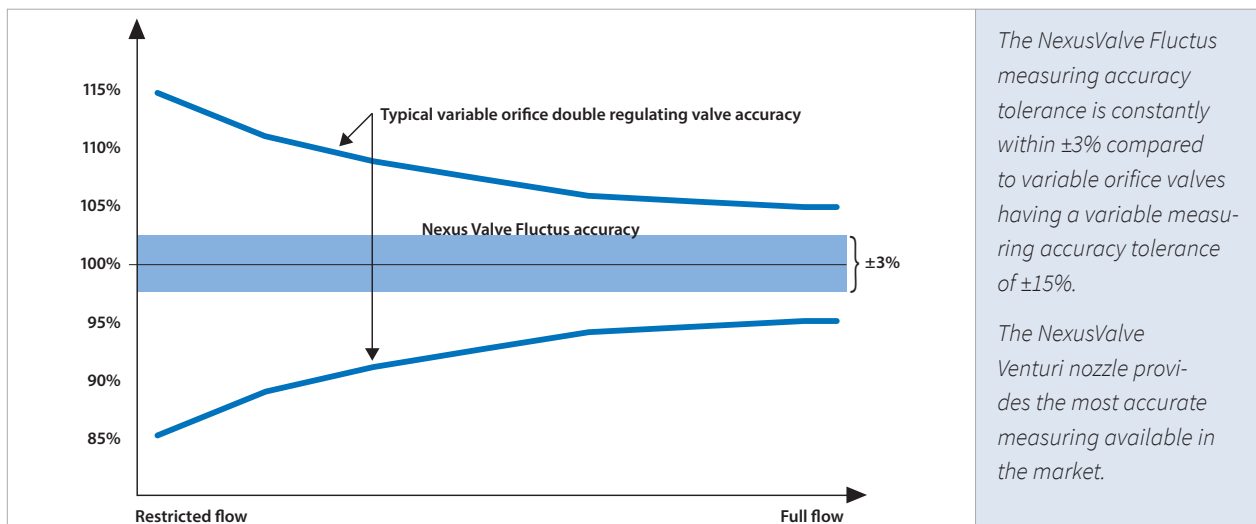

2.6 Mounting

Valves DN 15 - 50

An arrow on the NexusValve Fluctus housing indicates the flow direction to be respected. NexusValve Fluctus can be orientated 360° around the pipe axis and can be mounted directly onto bends, reducers, flexible pipes etc. A straight pipe of $5 \times$ pipe diameter before the valve is required only when the valve is mounted directly after the pump.

Valves DN 65 - 600

An arrow on the NexusValve Fluctus tube indicates the flow direction to be respected. NexusValve Fluctus can be installed with the gearbox pointing in any direction. However, if the gearbox is mounted pointing downwards, it is assumed that there are no impurities in the system. If there is a risk of impurities, it is recommended to install the gearbox in an angle from 60° to 300° around the pipe axis with reference to 0° at the bottom of the pipe. It is recommended to provide a straight pipe length of minimum $5 \times$ pipe diameter before the valve. If a pump is installed immediately in front of the valve, a straight pipe of $10 \times$ pipe diameter is required. There are no requirements for straight pipe lengths after the valve. The flow rate is adjusted by rotating the handle on the gearbox. The flow rate increases by rotating the handle to the left (counter-clockwise) and is reduced by rotating it to the right (clockwise).

2.7 Flow balancing

The NexusValve Fluctus valve is provided with measuring points for differential pressure measurement using any flowmeter. The setting of the NexusValve Fluctus is easily done using an Allen key. By rotating the Allen key in the valve handle the regulating needle inside the valve moves and changes the setting accordingly. The precise digital setting scale on top of the handle displays the setting which is easy to read even from a distance.

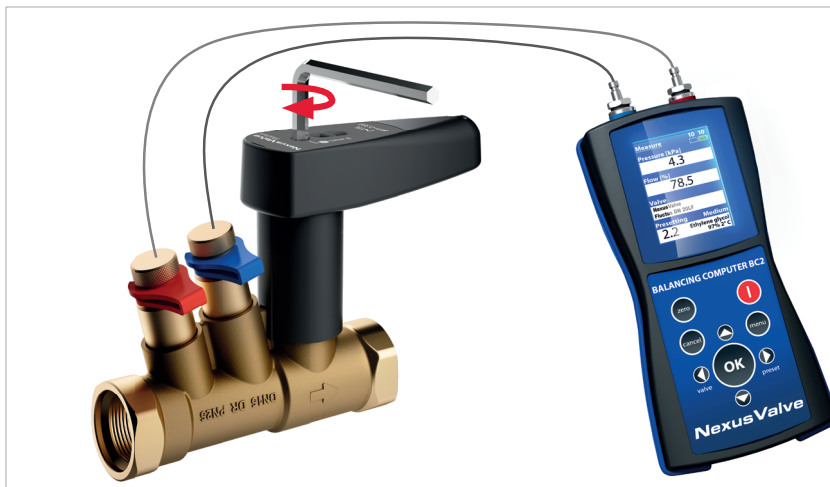

NexusValve provides a dedicated balancing computer, having all NexusValve valves data pre-stored. Hoses with needles are connected to the measuring points of the NexusValve Fluctus for differential pressure measurement. This can be converted into flow reading in the balancing computer.

For flow measurement the flowmeter is connected to the measuring points of the valve and the NexusValve Fluctus in question is chosen from the displayed list. The flow is thereafter displayed directly.

2.8 Operation

The NexusValve Fluctus can be used as a stand alone valve to provide the desired flow distribution within the controlled system. The valve is typically installed at terminal units, on branches, zones and main distribution pipes.

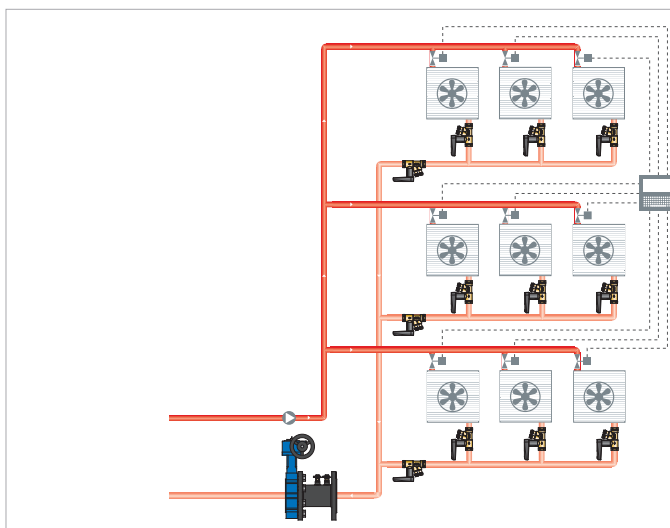

The NexusValve Fluctus valve can be used as a stand alone valve for flow balancing.

2. Introduction

The optional drain valve of the NexusValve Fluctus ensures at the same time the possibility of system draining or of connecting a capillary tube from a NexusValve Passim differential pressure control valve.

By combining NexusValve Fluctus and a NexusValve Passim in a system branch with terminal units, pressure fluctuations from the remaining part of the system will be eliminated within the controlled part of the branch. The designed flow set on the NexusValve Fluctus will at the same time never be exceeded due to the constant differential pressure regulation performed. System commissioning comprising NexusValve Fluctus in combination with a NexusValve Passim is quick and cost efficient.



The capillary tube is connected to the drain valve mounted before the regulating needle of the NexusValve Fluctus, and thus the valve is inside the circuit controlled by the NexusValve Passim. The pressure loss across the NexusValve Fluctus then needs to be taken into account when setting the NexusValve Passim differential pressure control valve.

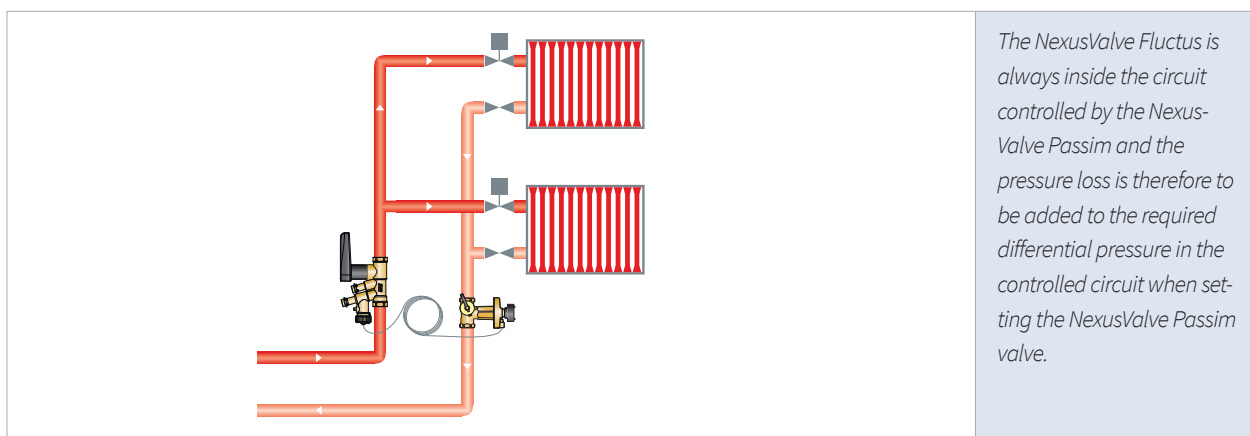

3. Applications

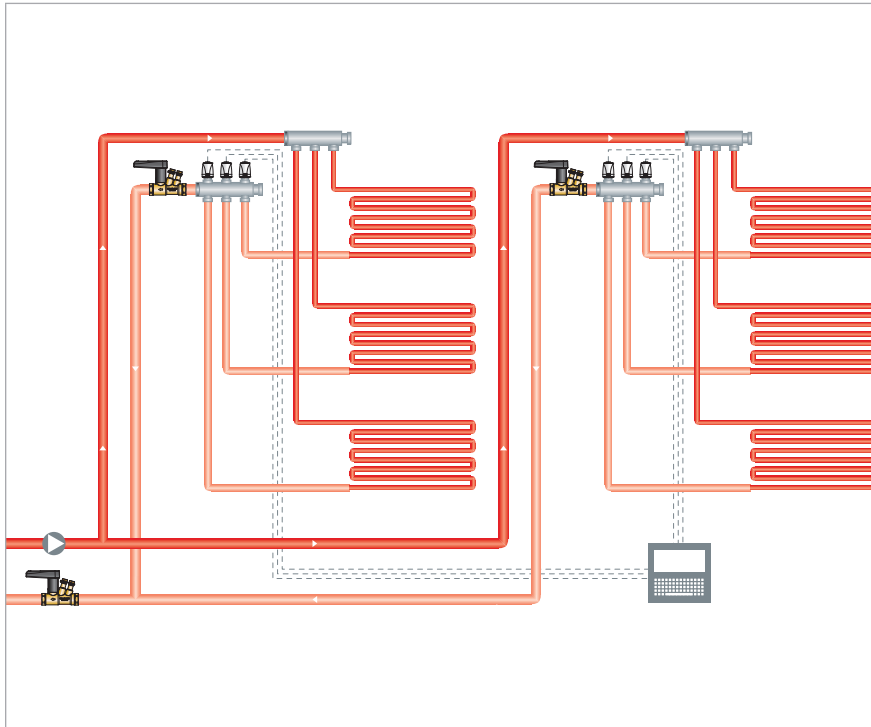

Application 1 - Underfloor heating

In an underfloor heating system the NexusValve Fluctus valves ensure the required flow distribution to all manifolds. Actuators connected to the BMS system or a room thermostat control the flow in each loop by opening or closing two-way valves in reference to the room air temperature. The flow and temperature is controlled to ensure the required indoor thermal comfort.

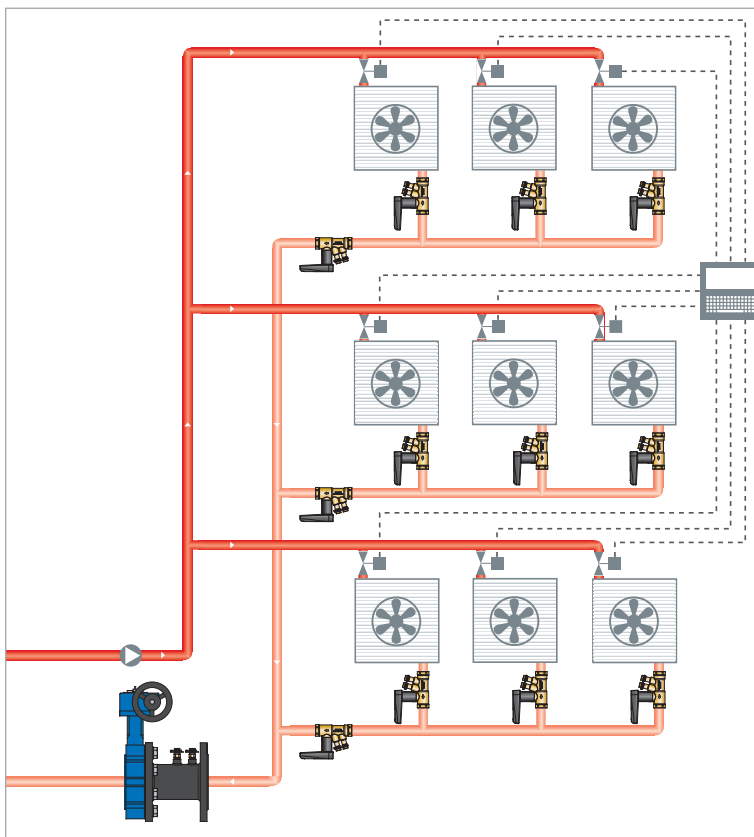

Application 2 - Variable flow system

In variable flow systems, with two-way motorized valves, the NexusValve Fluctus provides hydraulic balance and ensures that all units receive sufficient flow at maximum load (sizing) conditions. Actuators installed on two-way motorized valves are connected to a room thermostat or the BMS system to control the flow in each unit (such as a fan coil, air heater, radiant panel, and other). By opening or closing the two-way valves in reference to the air temperature, the required indoor thermal comfort is achieved.

3.Applications

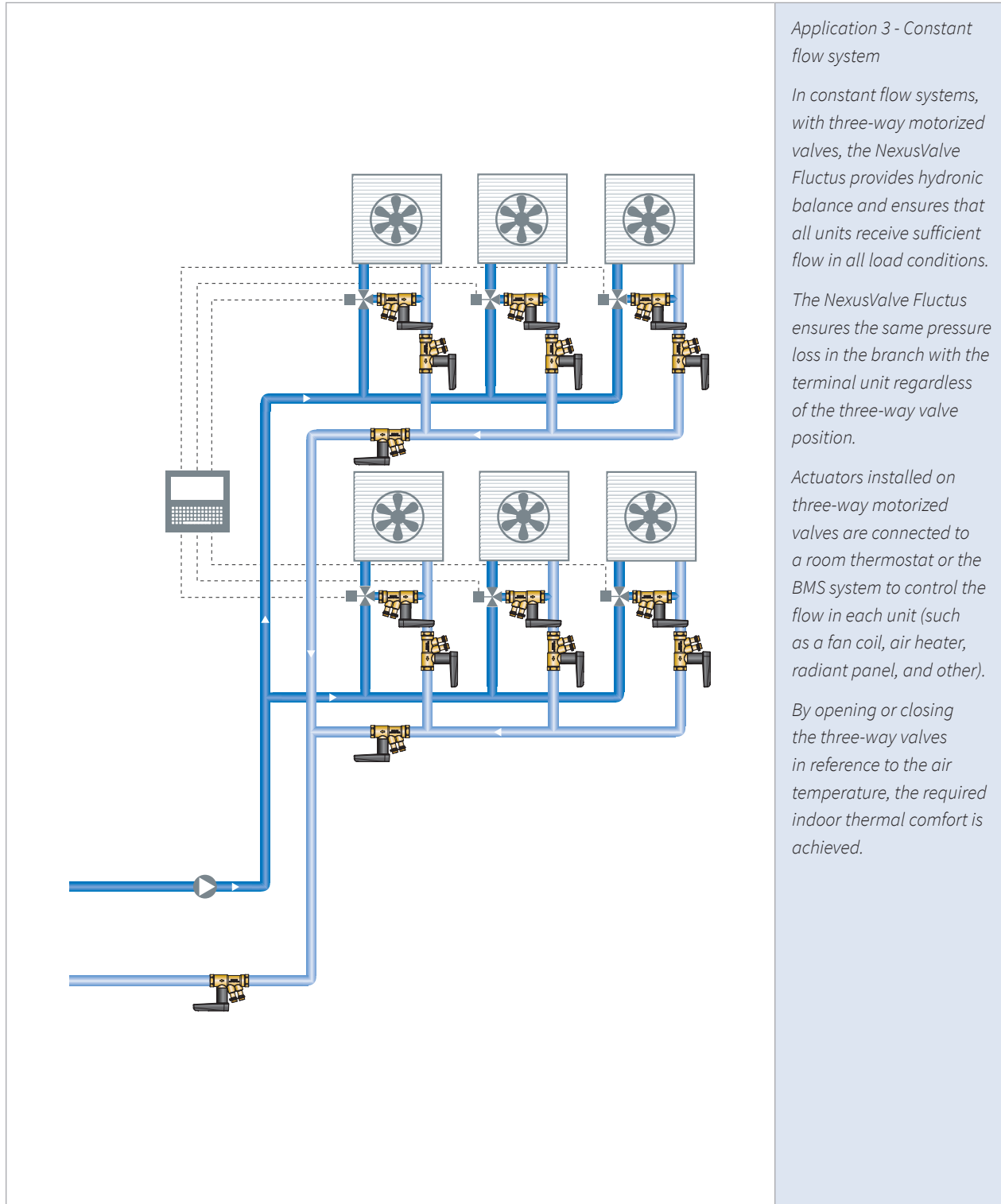

Application 3 - Constant flow system

In constant flow systems, with three-way motorized valves, the NexusValve Fluctus provides hydronic balance and ensures that all units receive sufficient flow in all load conditions.

The NexusValve Fluctus ensures the same pressure loss in the branch with the terminal unit regardless of the three-way valve position.

Actuators installed on three-way motorized valves are connected to a room thermostat or the BMS system to control the flow in each unit (such as a fan coil, air heater, radiant panel, and other).

By opening or closing the three-way valves in reference to the air temperature, the required indoor thermal comfort is achieved.

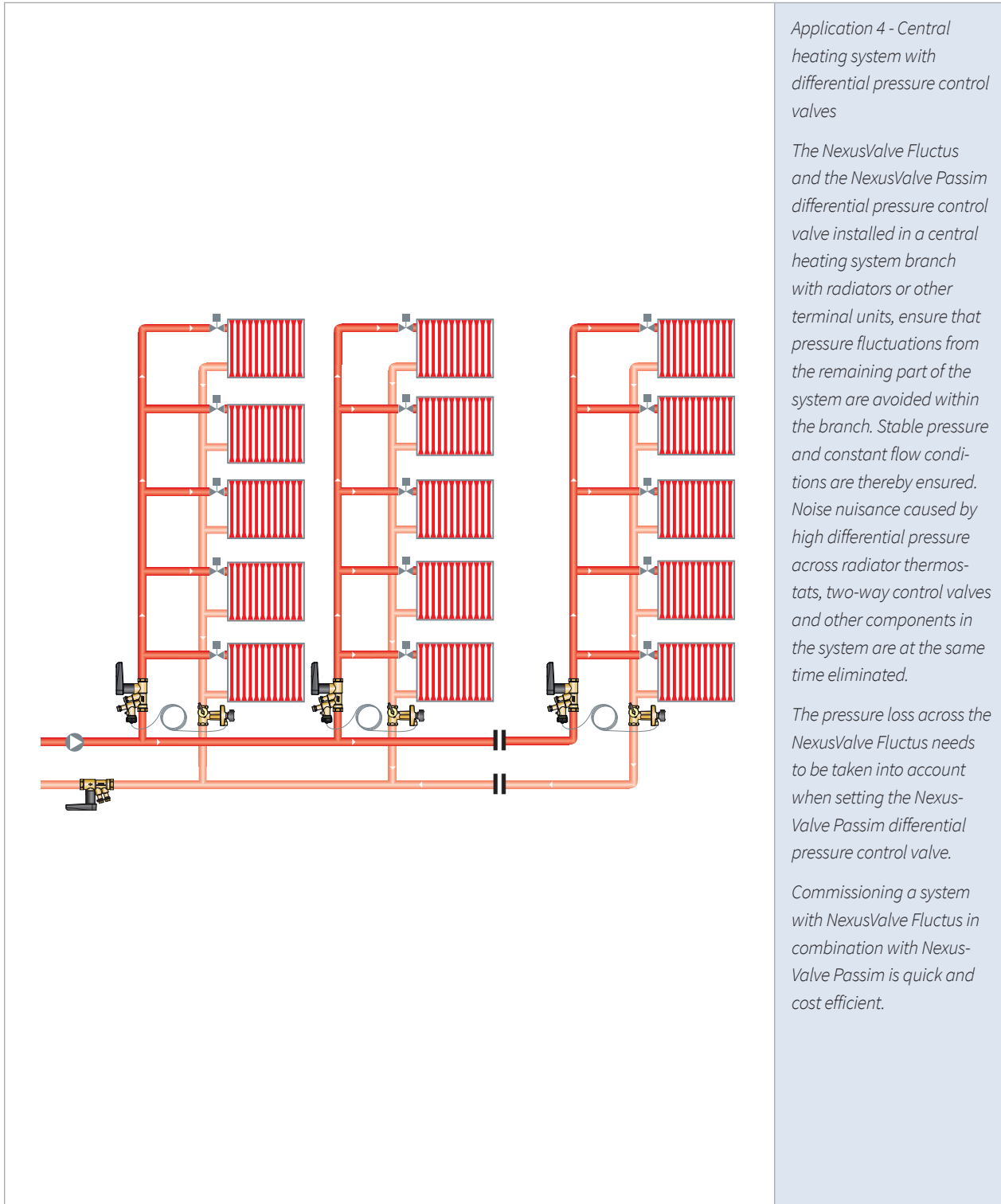

Application 4 - Central heating system with differential pressure control valves

The NexusValve Fluctus and the NexusValve Passim differential pressure control valve installed in a central heating system branch with radiators or other terminal units, ensure that pressure fluctuations from the remaining part of the system are avoided within the branch. Stable pressure and constant flow conditions are thereby ensured. Noise nuisance caused by high differential pressure across radiator thermostats, two-way control valves and other components in the system are at the same time eliminated.

The pressure loss across the NexusValve Fluctus needs to be taken into account when setting the NexusValve Passim differential pressure control valve.

Commissioning a system with NexusValve Fluctus in combination with NexusValve Passim is quick and cost efficient.

3.Applications

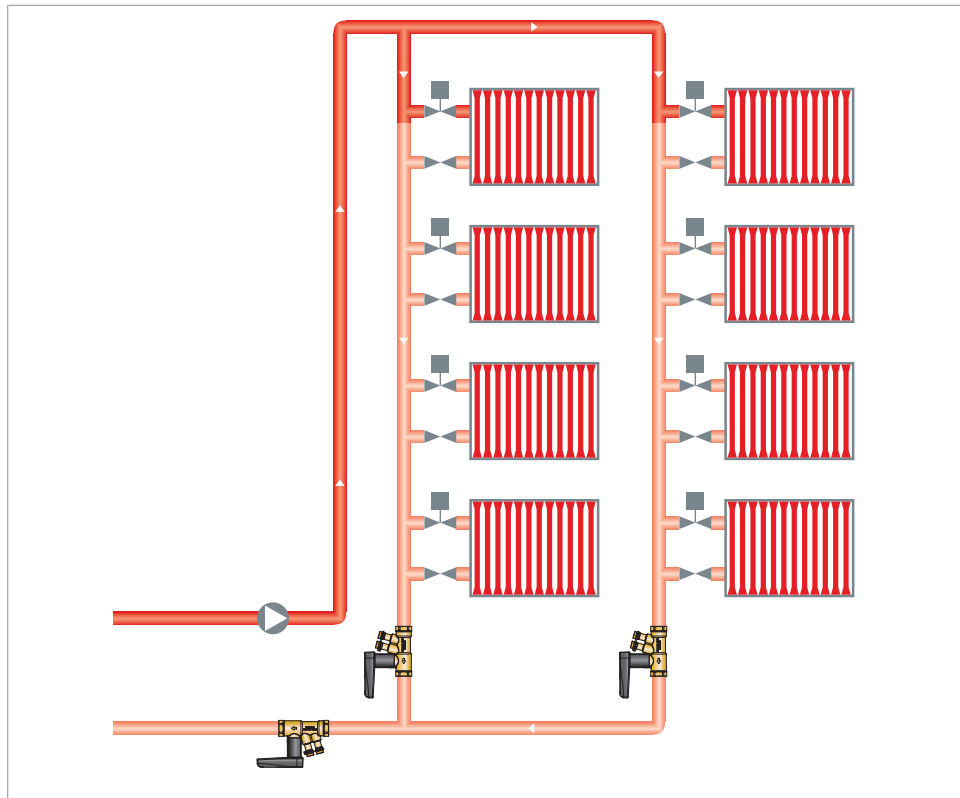

Application 5 -
One-pipe heating
system

NexusValve Fluctus valves installed in a one-pipe heating system ensure desired flow distribution through all branches and sections.

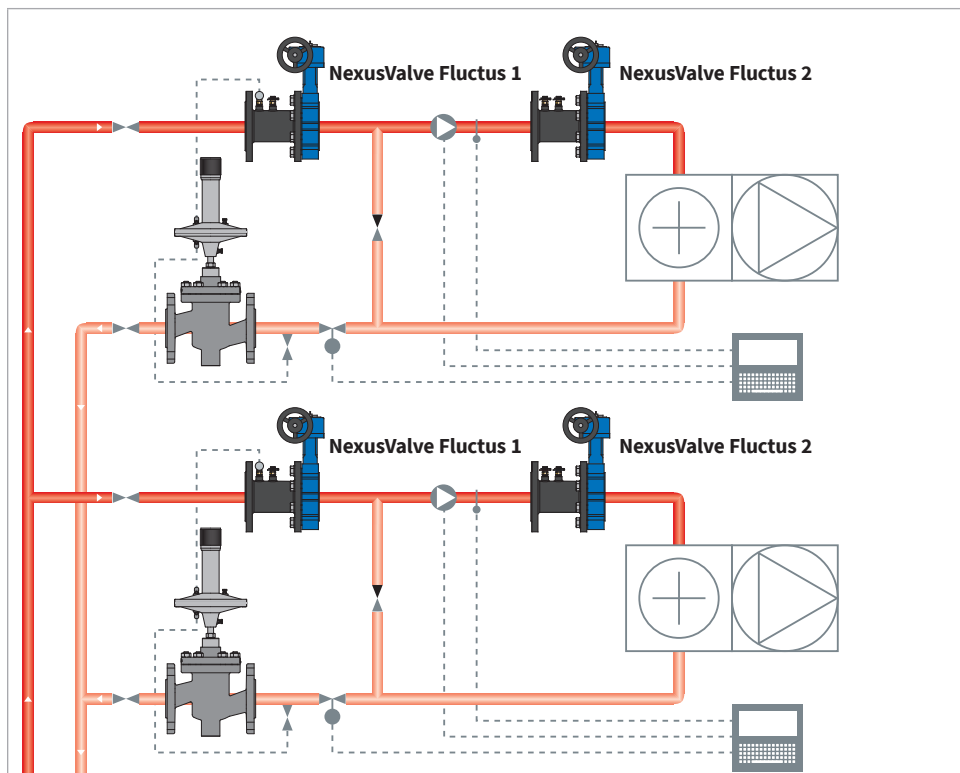

Application 6 - System
with air handling units

The combination of NexusValve Fluctus valves installed in a system with air handling units is used for precise flow control.

NexusValve Fluctus 1 with Combi Drain Maxi in combination with NexusValve Passim limits maximum (sizing) flow.

NexusValve Fluctus 2 helps to tune required temperature difference between the supply and the return lines of the air handling unit.

4. Product data sheet

4.1 Product finder

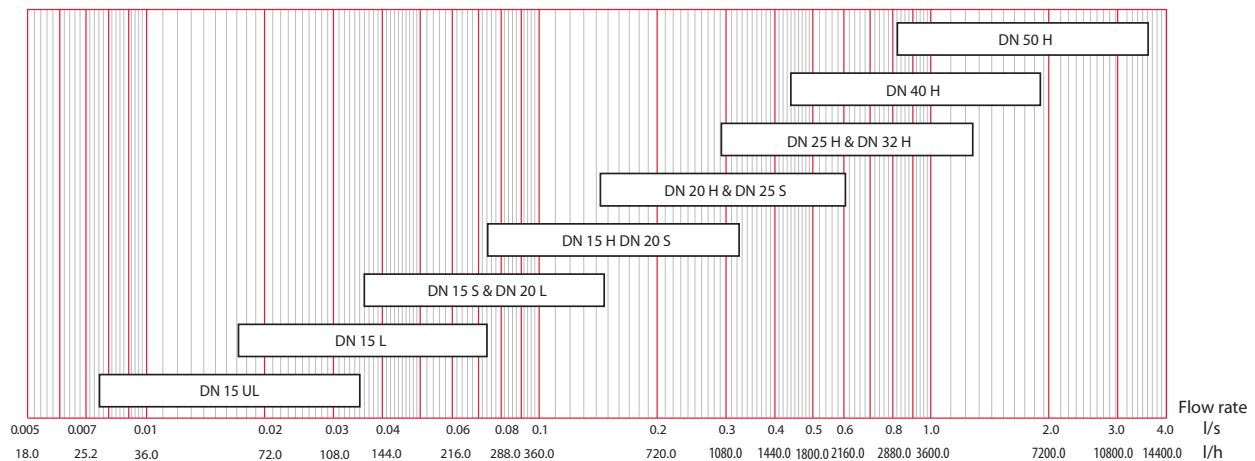

Flow range		Kvs m ³ /h	Dimension	Section
l/s	l/h			
0.0076-0.035	27-126	0.23	DN 15UL	4.4 - 30
0.0172-0.074	62-266	0.63	DN 15L	4.4 - 30
0.036-0.148	130-530	1.62	DN 15S	4.4 - 31
0.074-0.325	267-1170	2.49	DN 15H	4.4 - 31
0.036-0.148	130-530	1.43	DN 20L	4.4 - 32
0.074-0.325	267-1170	2.82	DN 20S	4.4 - 32
0.142-0.603	511-2170	5.72	DN 20H	4.4 - 33
0.142-0.603	511-2170	7.54	DN 25S	4.4 - 33
0.29-1.25	1040-4500	12.1	DN 25H	4.4 - 34
0.29-1.25	1040-4500	13.2	DN 32H	4.4 - 34
0.44-1.88	1580-6760	22.0	DN 40H	4.4 - 35
0.82-3.51	2950-12630	36.0	DN 50H	4.4 - 35

Note! The maximum flow range is based on normatives. Flow rates can be higher provided that cavitation does not occur. Sizing example should be consulted for higher flow rates.

4. Product data sheet

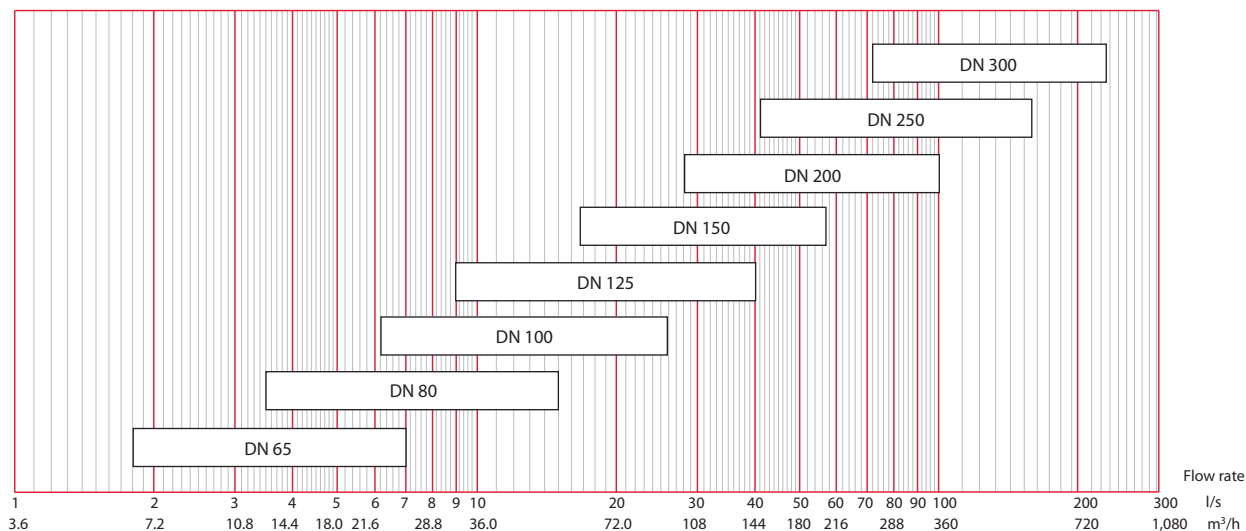

Flow range		Kvs m³/h	Dimension	Section
l/s	m³/h			
1.80-7.00	6.48-25.2	92.1	DN 65	4.4- 36
3.50-15.0	12.6-54.0	198	DN 80	4.4- 36
6.20-26.0	22.3-93.6	353	DN 100	4.4- 37
9.00-40.0	32.4-144	445	DN 125	4.4- 37
16.8-57.0	60.5-205	1200	DN 150	4.4- 38
28.0-100	101-360	2070	DN 200	4.4- 38
41.0-157	148-565	2990	DN 250	4.4- 39
72.0-226	259-814	4570	DN 300	4.4- 39
126-304	454-1093	approx. 6130*	DN 350	-
162-394	583-1420	approx. 7980*	DN 400	-
201-493	723-1780	approx. 10100*	DN 450	-
242-602	873-2170	approx. 12400*	DN 500	-
333-846	1200-3040	approx. 15600*	DN 600	-

*Product available upon request.

Note! The maximum flow range is based on normatives. Flow rates can be higher provided that cavitation does not occur. Sizing example should be consulted for higher flow rates.

4.2 NexusValve Fluctus DN 15-50







4.2.1 DN 15-50 female/female

Dimensions	Specifications
	<p>Max. temperature 120°C (135°C with high temperature measuring points)</p> <p>Min. temperature -20°C</p> <p>Max. pressure 25 bar</p> <p>Press ends 16 bar</p> <p>Marking on valve (Handle) DN, flow version, Kvm (Kv-measuring) (Valve body) DN, PN, flow direction</p> <p>Connection Female thread ISO 7/1 parallel</p> <p>Valve housing DR Brass CW602N</p> <p>Ball and needle DR Brass CW602N (chrome plated)</p> <p>Valve handle Polyamide (PA6.6 30%GF)</p> <p>Sealings O-rings EPDM Gaskets PTFE Test point sealing EPDM</p>

DN	A (mm)	B (mm)	C (mm)	D (mm)
15U	94	75	140	76
15L	94	75	140	76
15S	94	75	140	76
15H	94	75	140	76
20L	100	75	144	79
20S	100	75	144	79
20H	100	75	144	79
25S	112	75	150	83
25H	112	75	150	83
32H	130	122	208	109
40H	140	122	213	113
50H	156	122	221	120

Note! Information on insulation jockets, measuring points, press adaptors and other is provided in the chapter Accessories.

4. Product data sheet

Valve	Article	Dimension	Nom. Inch	Kvs m ³ /h	Kvm m ³ /h	Flow range l/h
DN 15						
	MN80597.400	DN 15U	½"	0.23	0.163	27-126
	MN80597.401	DN 15L	½"	0.63	0.359	62-226
	MN80597.402	DN 15S	½"	1.62	0.746	130-530
	MN80597.403	DN 15H	½"	2.49	1.56	267-1170
DN 20						
	MN80597.404	DN 20L	¾"	1.43	0.746	130-530
	MN80597.405	DN 20S	¾"	2.82	1.56	267-1170
	MN80597.406	DN 20H	¾"	5.72	2.95	511-2170
DN 25						
	MN80597.407	DN 25S	1"	7.54	2.95	511-2170
	MN80597.408	DN 25H	1"	12.1	6.01	1044-4500
DN 32						
	MN80597.409	DN 32H	1¼"	13.2	6.01	1044-4500
DN 40						
	MN80597.410	DN 40H	1½"	22.0	9.20	1580-6760
DN 40						
	MN80597.411	DN 50H	2"	36.0	17.1	2950-12630

Note! The Kvs value refers to the pressure loss across the entire valve. The Kvm value refers to the pressure loss across the measuring points and must be used only for flow verification during system commissioning.

4.2.2 With drain - DN 15-50 female/female

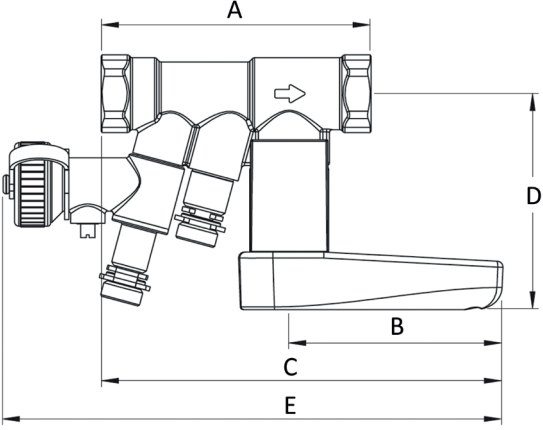





Dimensions	Specifications
	<p>Max. temperature 120°C Min. temperature -20°C Max. pressure 25 bar Press ends 16 bar Marking on valve (Handle) DN, flow version, Kvm (Kv-measuring) (Valve body) DN, PN, flow direction Connection Female thread ISO 7/1 parallel Valve housing DR Brass CW602N Ball and needle DR Brass CW602N (chrome plated) Valve handle Polyamide (PA6.6 30%GF) Sealings O-rings EPDM Gaskets PTFE Test point sealing EPDM</p>

DN	A (mm)	B (mm)	C (mm)	D (mm)	E (mm)
15U	94	75	140	76	174
15L	94	75	140	76	174
15S	94	75	140	76	174
15H	94	75	140	76	174
20L	100	75	144	79	174
20S	100	75	144	79	174
20H	100	75	144	79	174
25S	112	75	150	83	175
25H	112	75	150	83	175
32H	130	122	208	109	228
40H	140	122	213	113	234
50H	156	122	221	120	238

Note! Information on insulation jockets, measuring points, press adaptors and other is provided in the chapter Accessories.

Installation must be in the return, if integrated KFE-tap to be used for continuous draining!

4. Product data sheet

Valve	Article	Dimension	Nom. Inch	Kvs m ³ /h	Kvm m ² /h	Flow range l/h
DN 15						
	MN80597.530	DN 15U	½"	0.23	0.163	27-126
	MN80597.531	DN 15L	½"	0.63	0.359	62-226
	MN80597.532	DN 15S	½"	1.62	0.746	130-530
	MN80597.533	DN 15H	½"	2.49	1.56	267-1170
DN 20						
	MN80597.534	DN 20L	¾"	1.43	0.746	130-530
	MN80597.535	DN 20S	¾"	2.82	1.56	267-1170
	MN80597.536	DN 20H	¾"	5.72	2.95	511-2170
DN 25						
	MN80597.537	DN 25S	1"	7.54	2.95	511-2170
	MN80597.538	DN 25H	1"	12.1	6.01	1044-4500
DN 32						
	MN80597.539	DN 32H	1¼"	13.2	6.01	1044-4500
DN 40						
	MN80597.540	DN 40H	1½"	22.0	9.20	1580-6760
DN 50						
	MN80597.541	DN 50H	2"	36.0	17.1	2950-12630

Note! The Kvs value refers to the pressure loss across the entire valve. The Kvm value refers to the pressure loss across the measuring points and must be used only for flow verification during system commissioning.



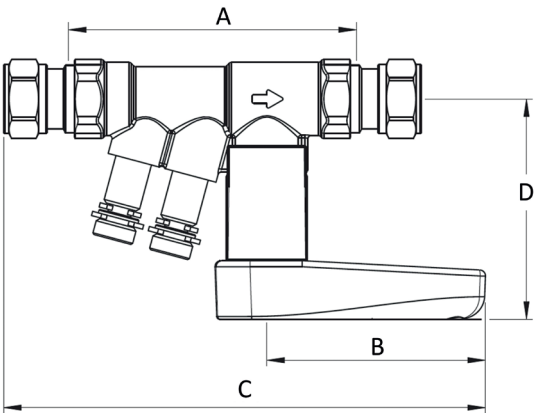



4.2.3 DN 15 compression/compression

Dimensions	Specifications
	<p>Max. temperature 120°C</p> <p>Max. pressure</p> <p>DN 15 - 25 20 bar at 30°C, 16 bar at 95°C, 10 bar at 120°C</p> <p>DN 32 - 50 16 bar at 30°C, 13 bar at 95°C, 5 bar at 120°C</p> <p>Marking on valve (Handle) DN, flow version, Kvm (Kv-measuring) (Valve body) DN, PN, flow direction</p> <p>Connection Compression EN 1254-2</p> <p>Valve housing DR Brass CW602N</p> <p>Ball and needle DR Brass CW602N (chrome plated)</p> <p>Valve handle Polyamide (PA6.6 30%GF)</p> <p>Sealings O-rings EPDM Gaskets PTFE Test point sealing EPDM</p> <p>Compression connections are not recommended for cooling applications. Instead press or threaded connections are recommended.</p>

DN	A (mm)	B (mm)	C (mm)	D (mm)
15U	99	75	164	76
15L	99	75	164	76
15S	99	75	164	76
15H	99	75	164	76
20L	105	75	170	79
20S	105	75	170	79
20H	105	75	170	79
25S	118	75	177	83
25H	118	75	177	83
32H	135	122	241	109
40H	149	122	253	113
50H	167	122	265	120

Note! Information on insulation jockets, measuring points, press adaptors and other is provided in the chapter Accessories.

4. Product data sheet

Valve	Article	Dimension	Nom. Inch	Kvs m ³ /h	Kvm m ³ /h	Flow range l/h
DN 15						
	MN80597.420	DN 15U	½"	0.23	0.163	27-126
	MN80597.421	DN 15L	½"	0.63	0.359	62-226
	MN80597.422	DN 15S	½"	1.62	0.746	130-530
	MN80597.423	DN 15H	½"	2.49	1.56	267-1170
DN 20						
	MN80597.424	DN 20L	¾"	1.43	0.746	130-530
	MN80597.425	DN 20S	¾"	2.82	1.56	267-1170
	MN80597.426	DN 20H	¾"	5.72	2.95	511-2170
DN 25						
	MN80597.427	DN 25S	1"	7.54	2.95	511-2170
	MN80597.428	DN 25H	1"	12.1	6.01	1044-4500
DN 32						
	MN80597.429	DN 32H	1¼"	13.2	6.01	1044-4500
DN 40						
	MN80597.430	DN 40H	1½"	22.0	9.20	1580-6760
DN 50						
	MN80597.431	DN 50H	2"	36.0	17.1	2950-12630

Note! The Kvs value refers to the pressure loss across the entire valve. The Kvm value refers to the pressure loss across the measuring points and must be used only for flow verification during system commissioning.

4.2.4 DN 15-50 flange/flange

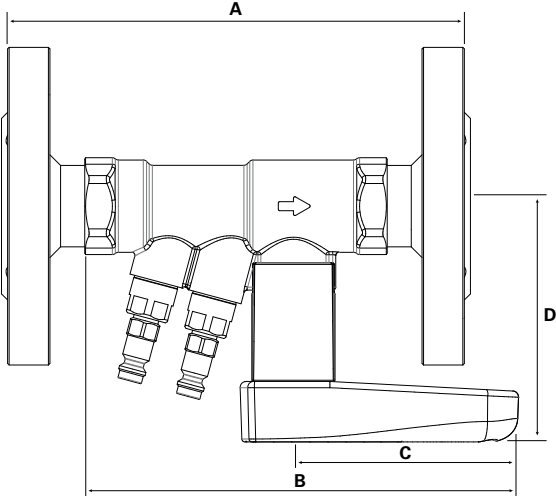
Dimensions	Specifications
	<p>Max. temperature 135°C Min. temperature -20°C Max. pressure 16 bar/25 bar Marking on valve (Handle) DN, flow version, Kvm (Kv-measuring) (Valve body) DN, PN, flow direction</p> <p>Flange EN 1092-1 PN16 Valve housing DR Brass CW602N Ball and needle DR Brass CW602N (chrome plated) Valve handle Polyamide (PA6.6 30%GF) Sealings O-rings EPDM Gaskets PTFE Test point sealing EPDM</p> <p>Flanges Carbon steel EN 1092-1 PN16</p>

DN	A (mm)	B (mm)	C (mm)	D (mm)
15U	134	140	75	76
15L	134	140	75	76
15S	134	140	75	76
15H	134	140	75	76
20L	155	144	75	79
20S	155	144	75	79
20H	155	144	75	79
25S	167	150	75	83
25H	167	150	75	83
32H	195	208	122	109
40H	215	213	122	113
50H	231	221	122	120

Note! Information on insulation jockets, measuring points, press adaptors and other is provided in the chapter Accessories.

4. Product data sheet

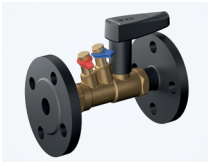
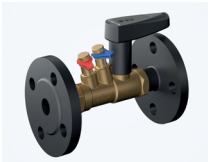
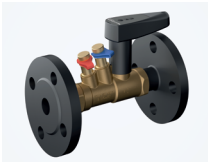
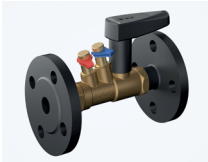
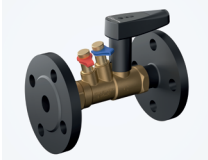
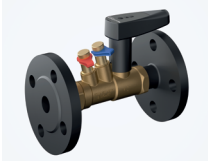
Valve	Article	Dimension	Nom. Inch	Kvs m ³ /h	Kvm m ³ /h	Flow range l/h
DN 15						
	MN80597.450	DN 15U	½"	0.23	0.163	27-126
	MN80597.451	DN 15L	½"	0.63	0.359	62-226
	MN80597.452	DN 15S	½"	1.62	0.746	130-530
	MN80597.453	DN 15H	½"	2.49	1.56	267-1170
DN 20						
	MN80597.454	DN 20L	¾"	1.43	0.746	130-530
	MN80597.455	DN 20S	¾"	2.82	1.56	267-1170
	MN80597.456	DN 20H	¾"	5.72	2.95	511-2170
DN 25						
	MN80597.457	DN 25S	1"	7.54	2.95	511-2170
	MN80597.458	DN 25H	1"	12.1	6.01	1044-4500
DN 32						
	MN80597.459	DN 32H	1¼"	13.2	6.01	1044-4500
DN 40						
	MN80597.460	DN 40H	1½"	22.0	9.20	1580-6760
DN 50						
	MN80597.461	DN 50H	2"	36.0	17.1	2950-12630

Note! The Kvs value refers to the pressure loss across the entire valve. The Kvm value refers to the pressure loss across the measuring points and must be used only for flow verification during system commissioning.

NexusValve Fluctus with flanges is provided with high temperature measuring points. Any flowmeter with quick coup-lings can be connected to the measuring points. The NexusValve Balancing computer can be connected to the high temperature measuring points after removing the needles from the hoses.

4.3 NexusValve Fluctus DN 65-600 flange/flange

Dimensions	Specifications
	<p>Max. temperature 120°C Min. temperature -20°C Max. pressure 16 bar Marking on valve (Fluctus pipe) DN, max. temperature, flow direction (Butterfly gearbox) Valve type, DN, Kvm</p> <p>Connection Flange: EN 1092-1 PN16 Valve pipe Carbon steel Butterfly valve body Cast iron, fully lugged (ASTM A126 KL.B)</p> <p>Disc Stainless steel (ASTM A351) Shaft Stainless steel (ASTM A276) Test points DR Brass CW602N Sealings EPDM and NBR</p>

DN	A (mm)	B (mm)	C (mm)	D (mm)	∅ (mm)
65	185	185	270	165	140
80	250	200	275	165	140
100	325	220	310	165	140
125	340	250	320	165	140
150	355	285	320	165	140
200	380	340	390	165	200
250	410	405	485	230	300
300	465	460	530	230	300
350	550	520	555	240	300
400	570	580	665	340	415
450	680	640	690	340	415
500	750	715	750	340	420
600	880	840	935	475	585

Note! Information on insulation jockets, measuring points, press adaptors and other is provided in the chapter Accessories.

4. Product data sheet

Valve	Article	Dimension	Nom. Inch	Kvs m ³ /h	Kvm m ³ /h	Flow range m ³ /h
DN 65 	MN80597.471	DN 65	2½"	92.1	37.4	6.48-25.2
DN 80 	MN80597.472	DN 80	3"	198	72.9	12.6-54.0
DN 100 	MN80597.473	DN 100	4"	353	129	22.3-93.6
DN 125 	MN80597.474	DN 125	5"	445	190	32.4-144
DN 150 	MN80597.475	DN 150	6"	1200	348	60.5-205
DN 200 	MN80597.476	DN 200	8"	2070	586	101-360
DN 250 	MN80597.477	DN 250	10"	2990	861	148-565

Valve	Article	Dimension	Nom. Inch	Kvs m ³ /h	Kvm m ³ /h	Flow range m ³ /h
DN 300 	MN80597.478	DN 300	12"	4570	1513	259-814
DN 350 	MN80597.479	DN 350	14"	approx. 6130*	2620	454-1093
DN 400 	MN80597.480	DN 400	16"	approx. 7980*	3370	583-1420
DN 450 	MN80597.481	DN 450	18"	approx. 10100*	4170	723-1780
DN 500 	MN80597.482	DN 500	20"	approx. 12400*	5040	873-2170
DN 600 	MN80597.483	DN 600	24"	approx. 15600*	6920	1200-3040

*Product available upon request.

Note! The Kvs value refers to the pressure loss across the entire valve. The Kvm value refers to the pressure loss across the measuring points and must be used only for flow verification during system commissioning.

4. Product data sheet

4.4 Flow diagrams

The black continuous graph lines determine the total pressure drop across the valve at a specific handle scale setting and flow rate. The graph is used during a hydronic system design to specify the setting of the valve.

DN 15UL - Ultra low flow

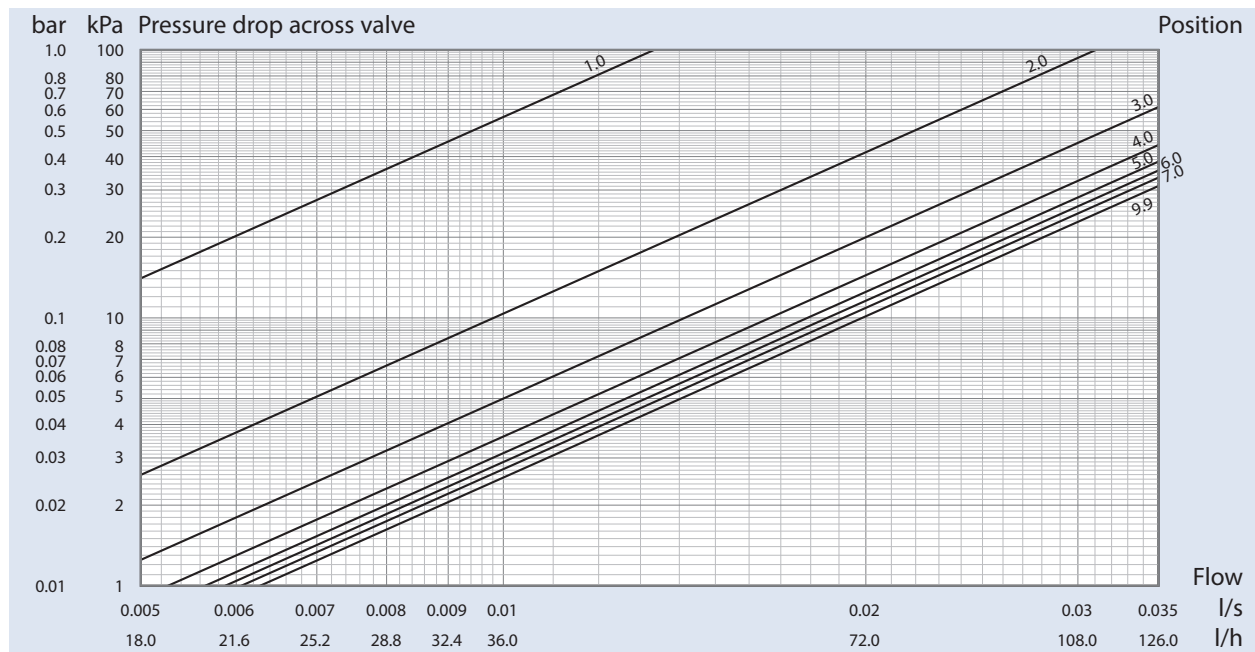

DN 15L - Low flow

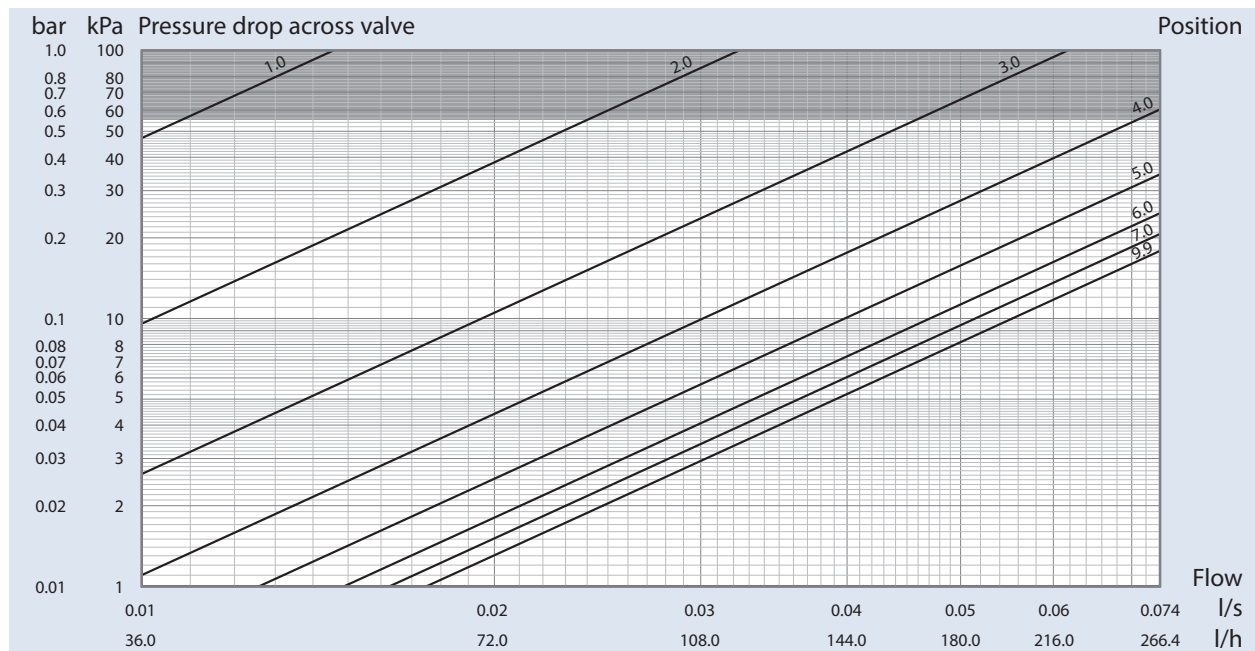

DN 15S - Standard flow

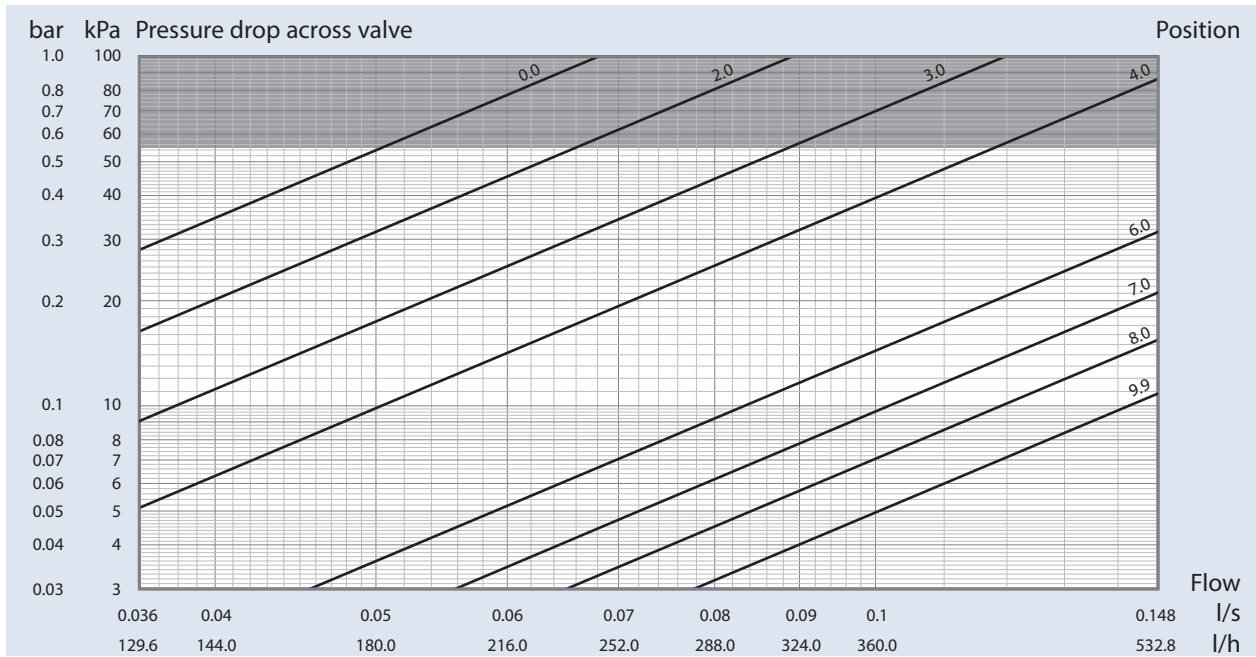

DN 15H - High flow

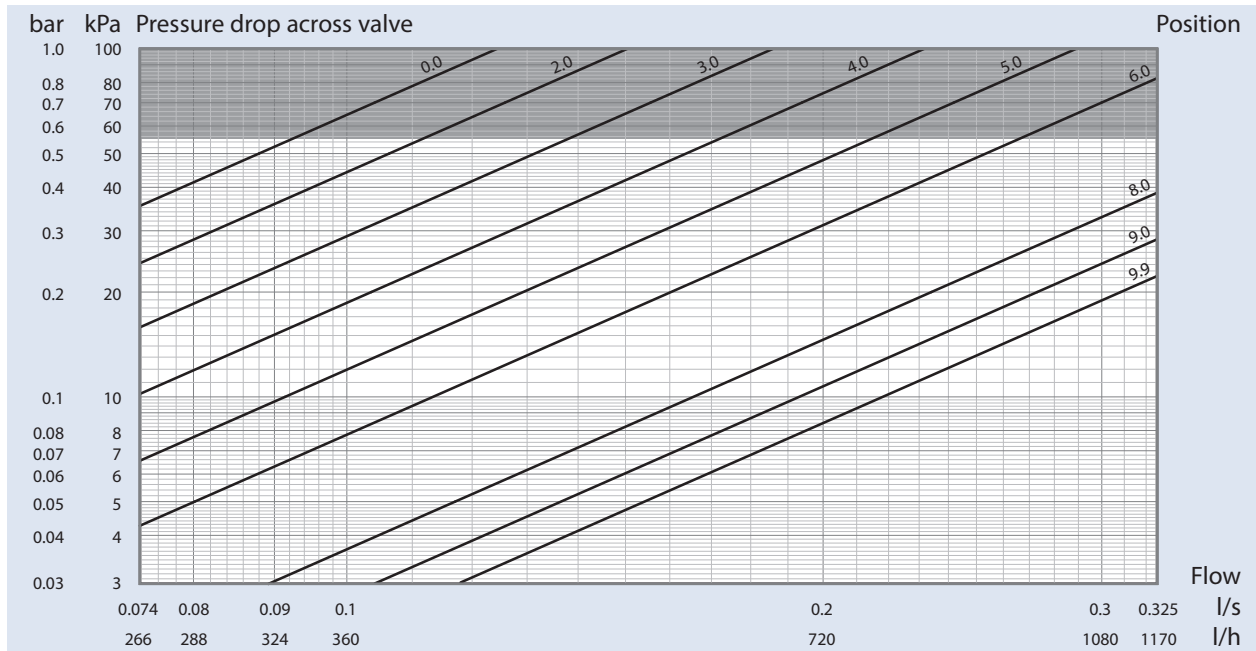

4. Product data sheet

DN 20L - Low flow

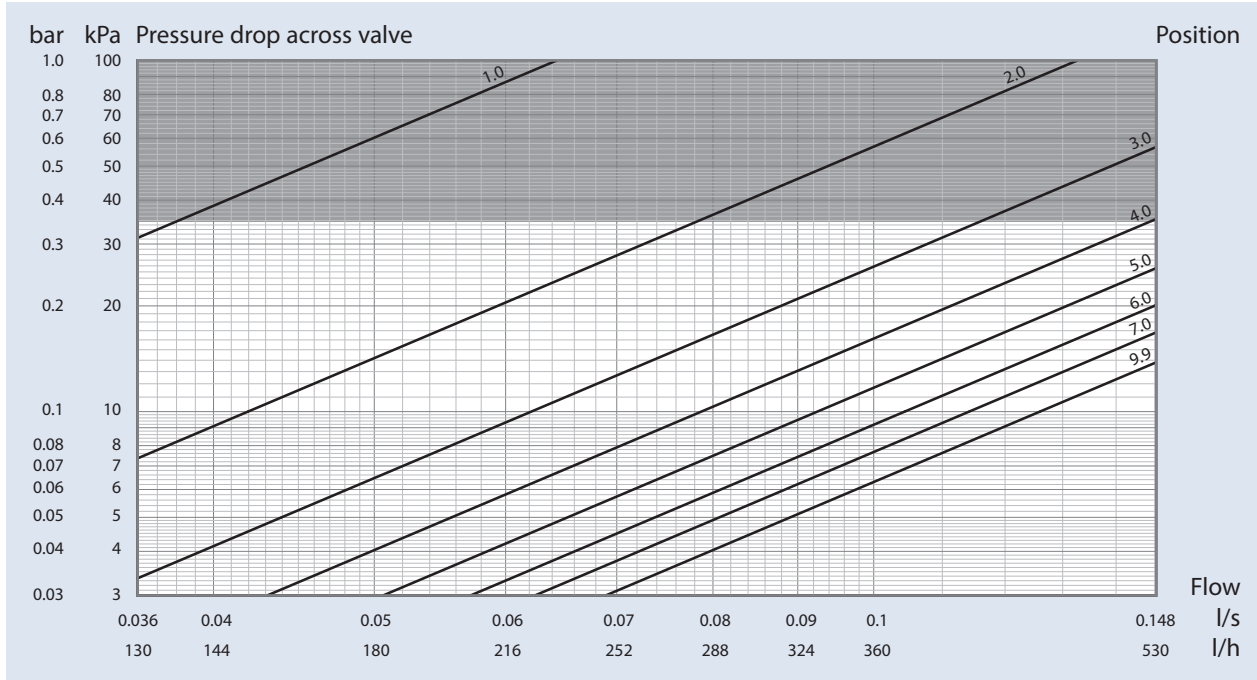

DN 20S - Standard flow

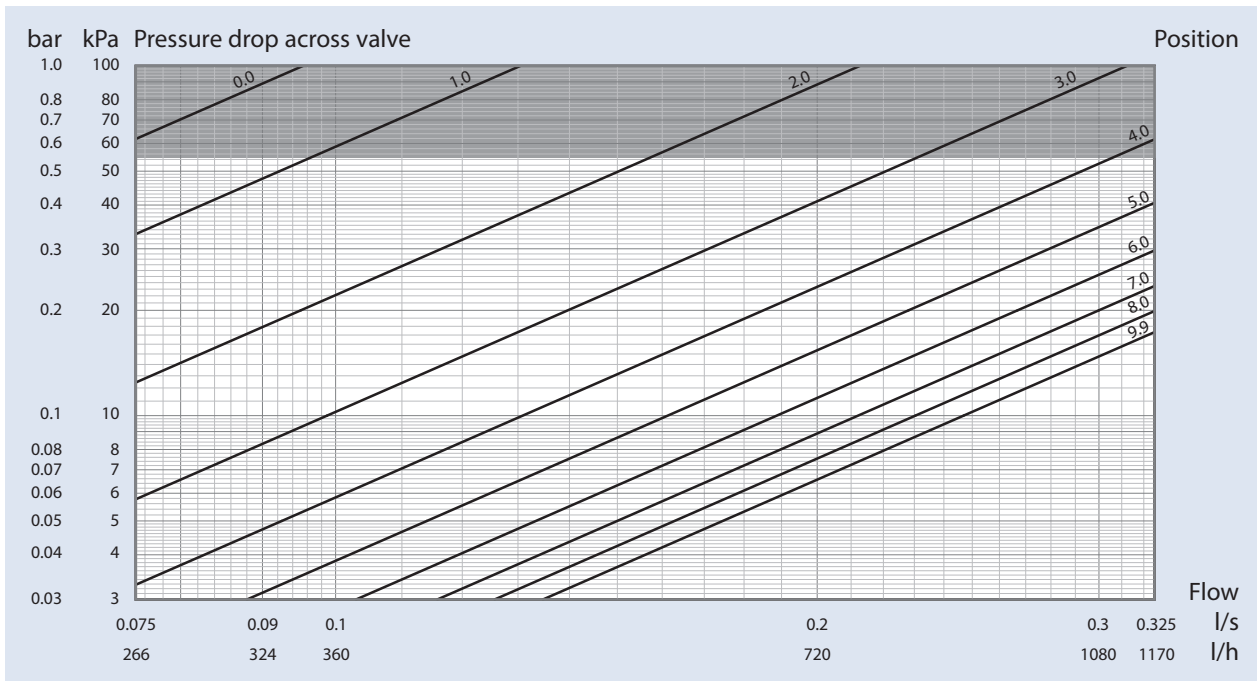

DN 20H - High flow

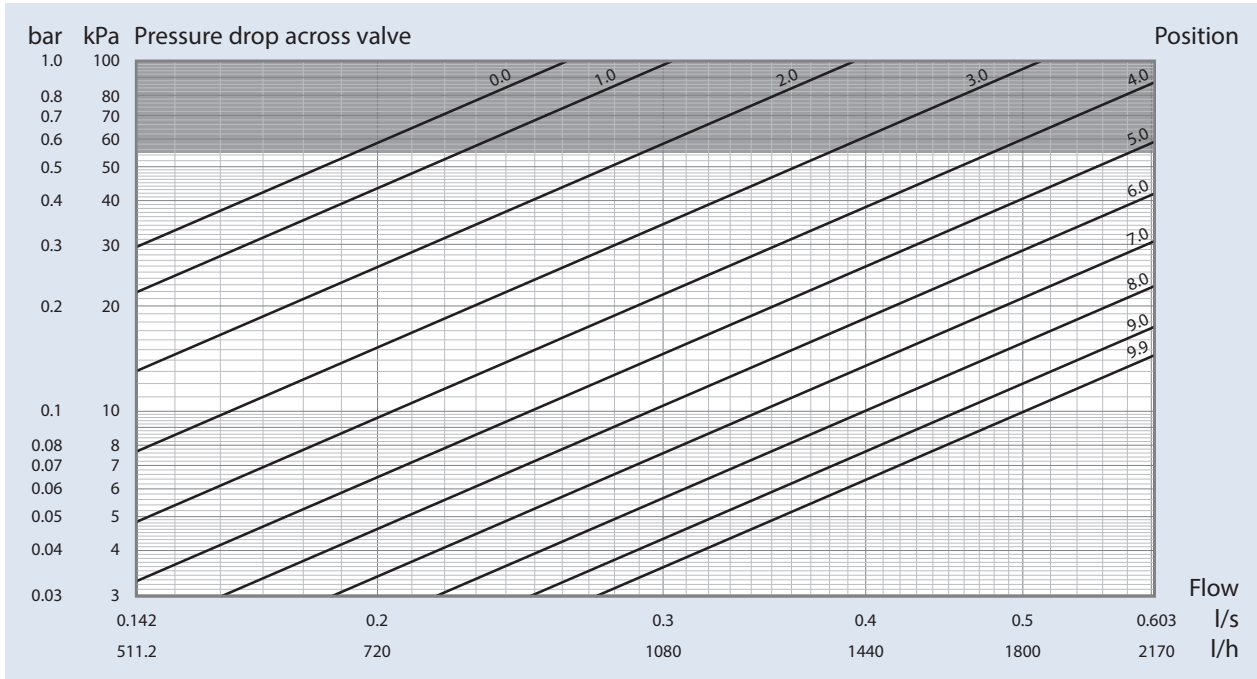

DN 25S - Standard flow

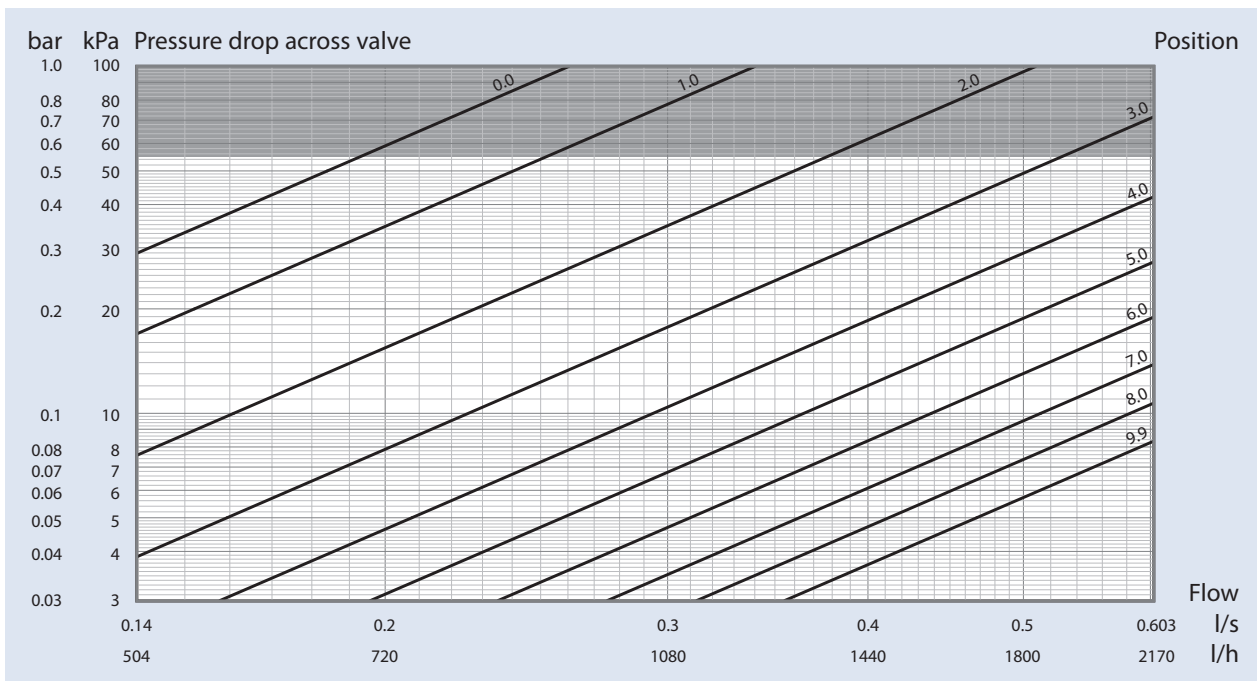

4. Product data sheet

DN 25H - High flow

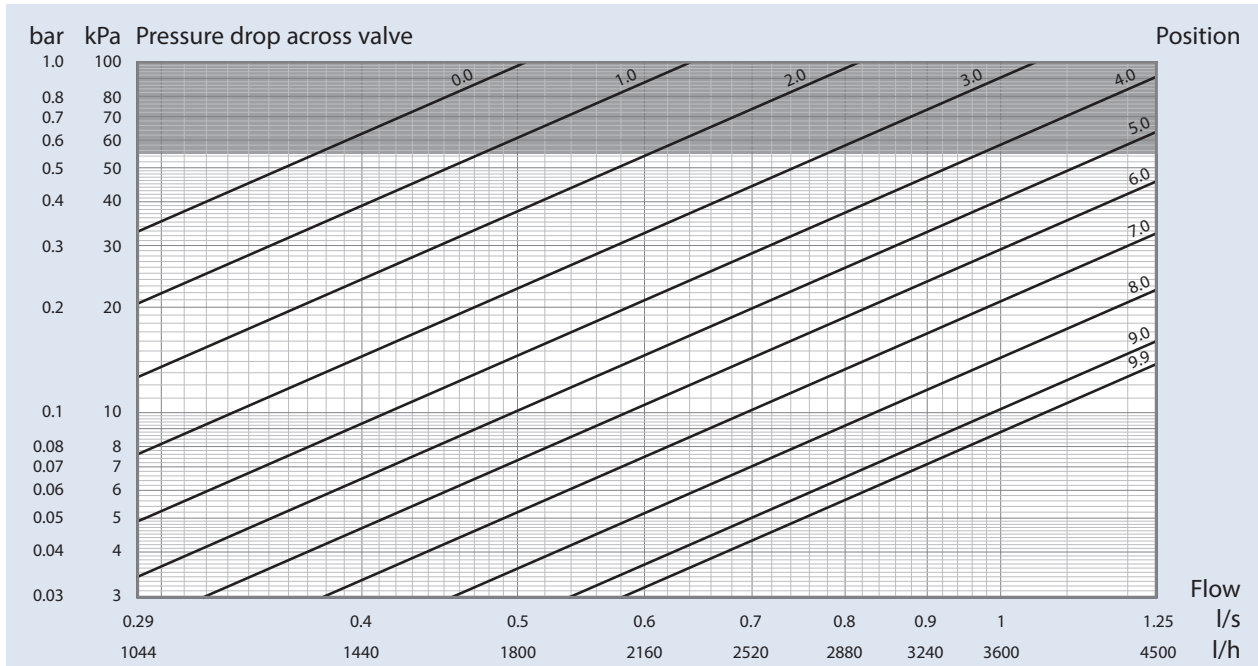

DN 32H - High flow

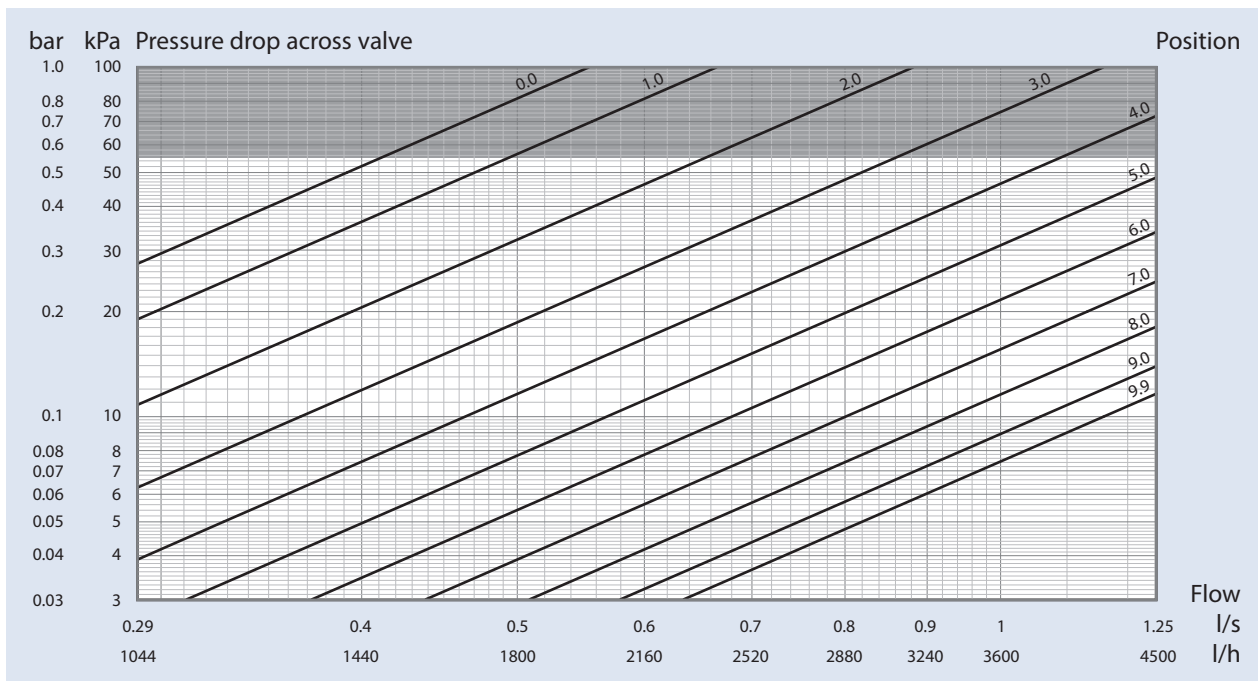

DN 40H - High flow

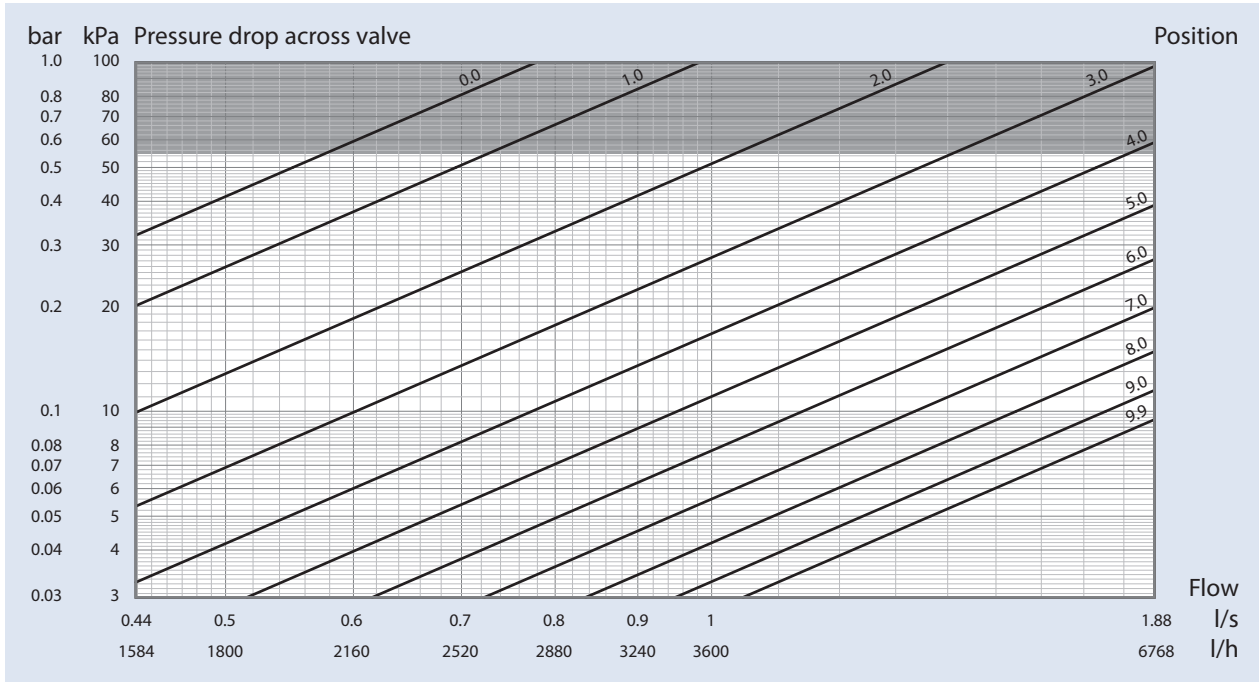

DN 50H - High flow

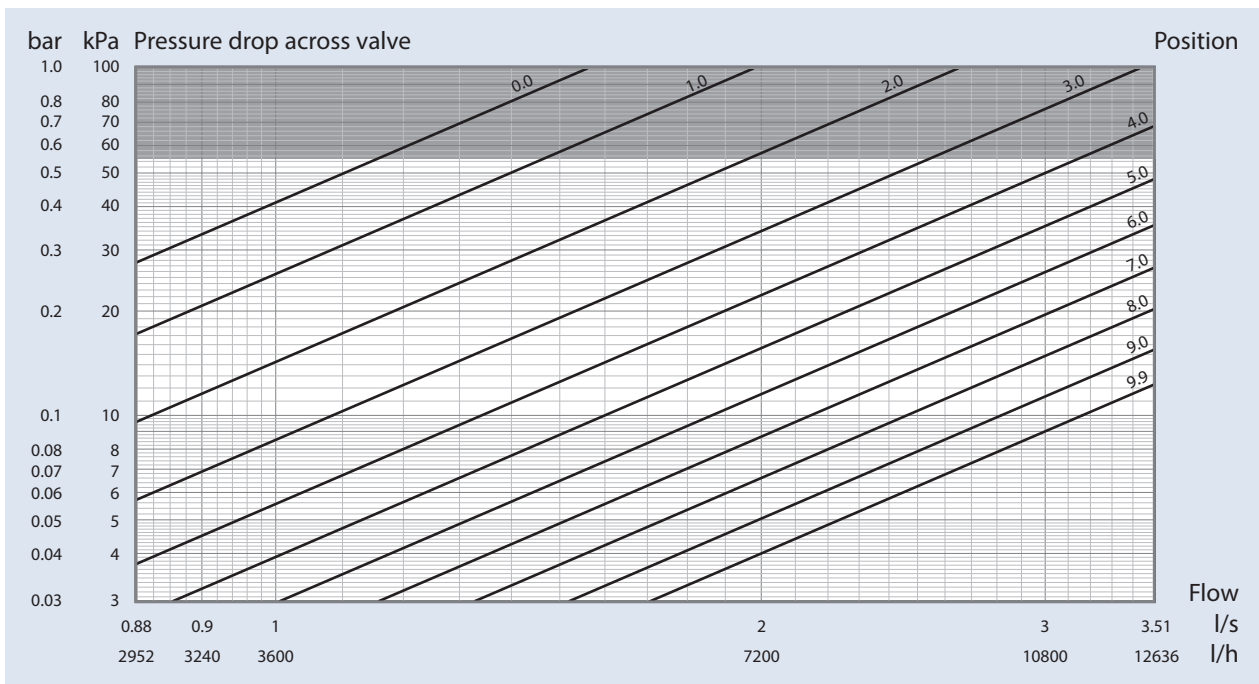

4. Product data sheet

DN 65

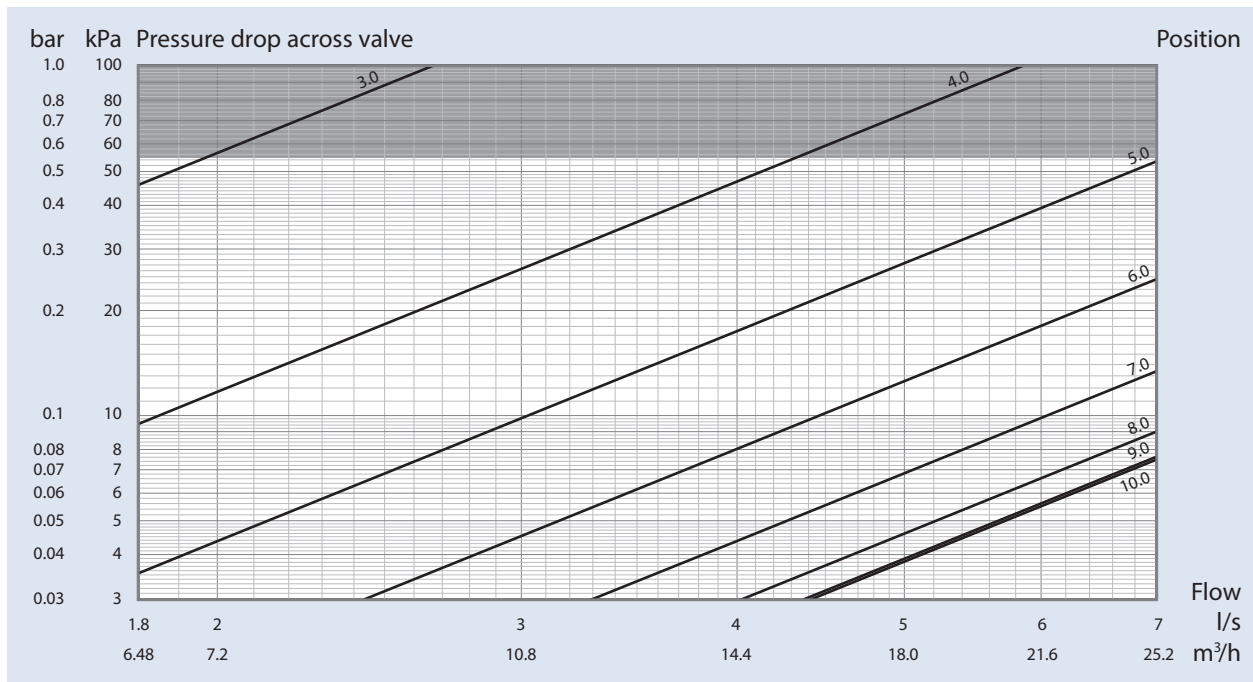

DN 80

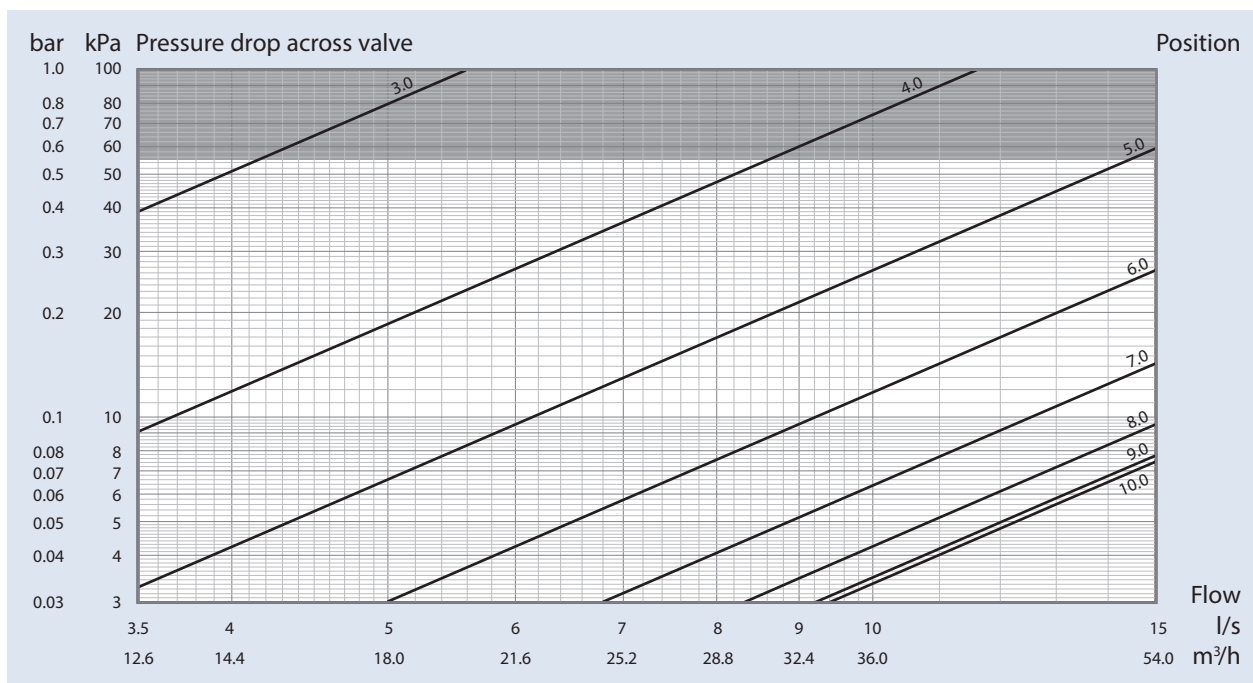

DN 100

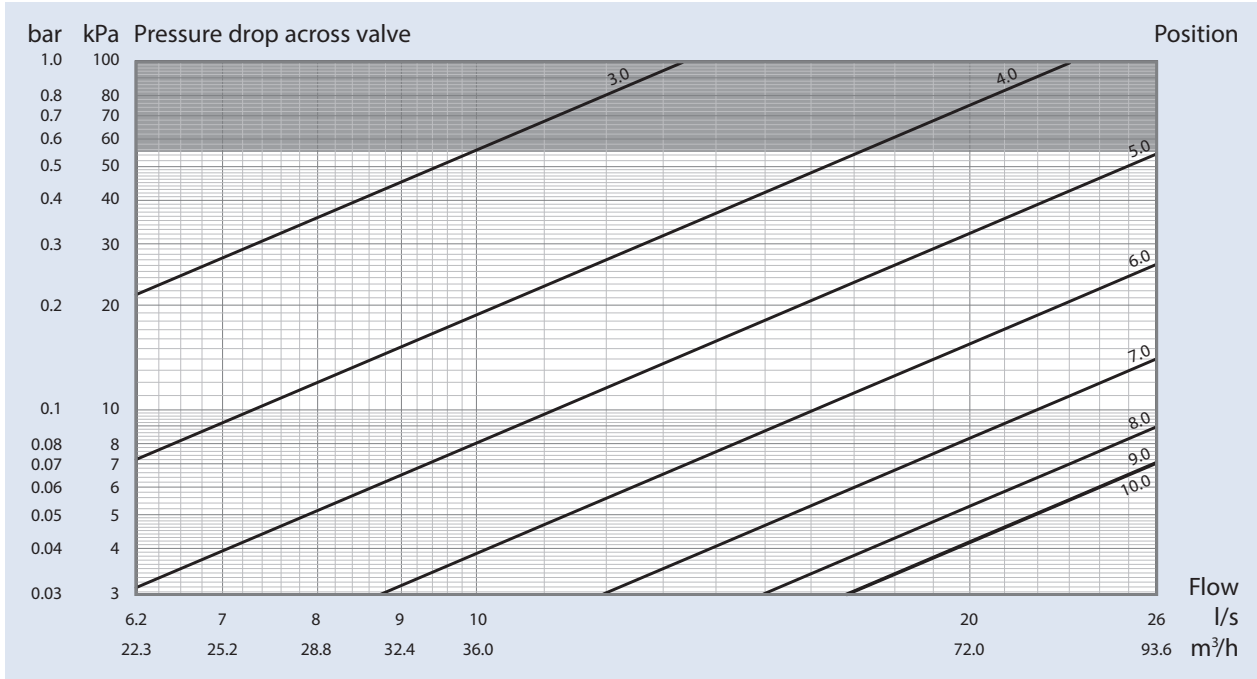

DN 125

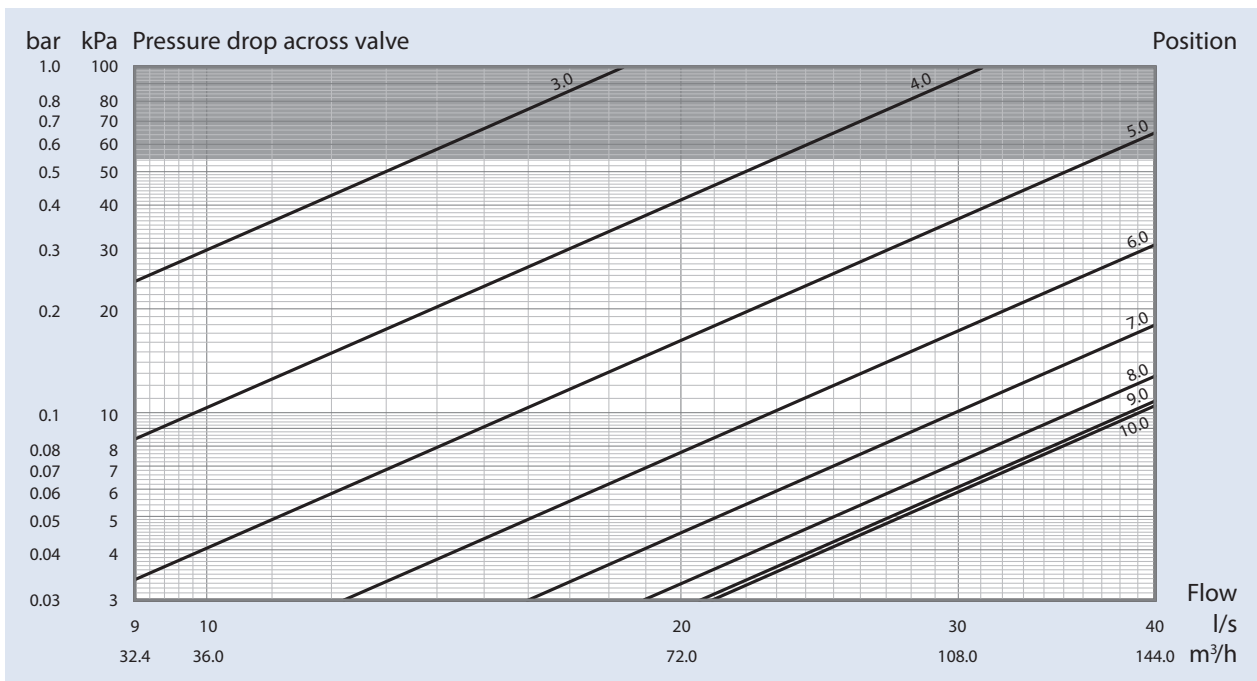

4. Product data sheet

DN 150

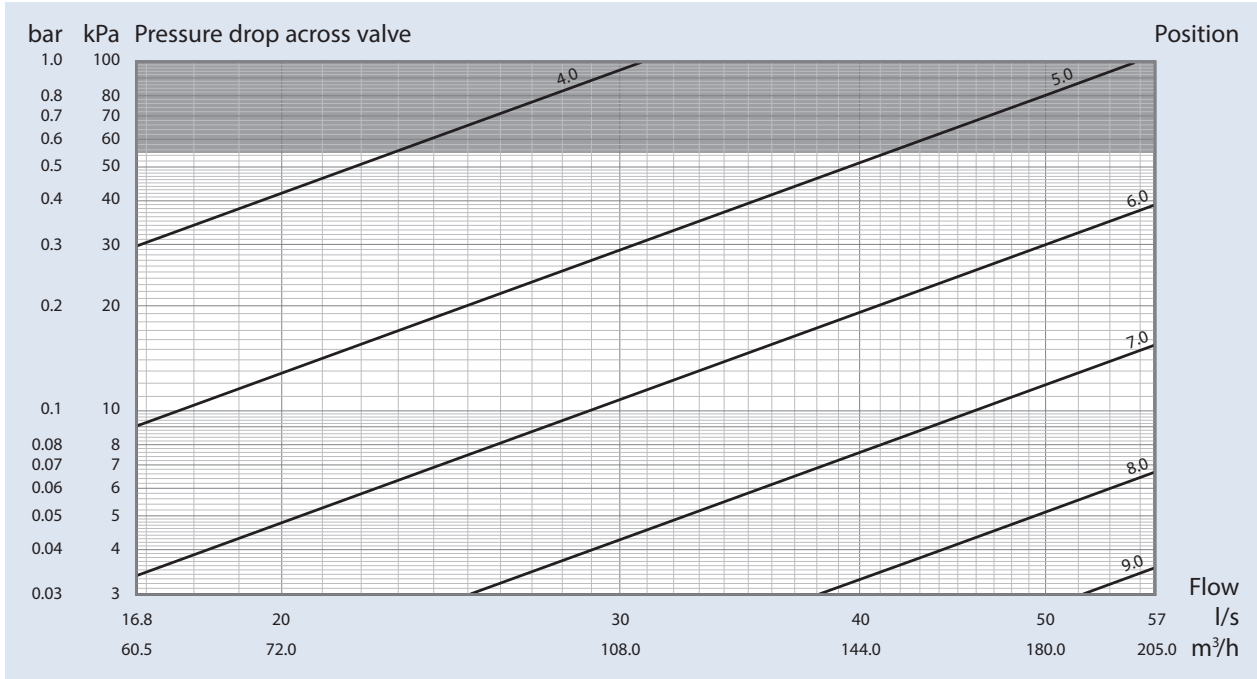

DN 200

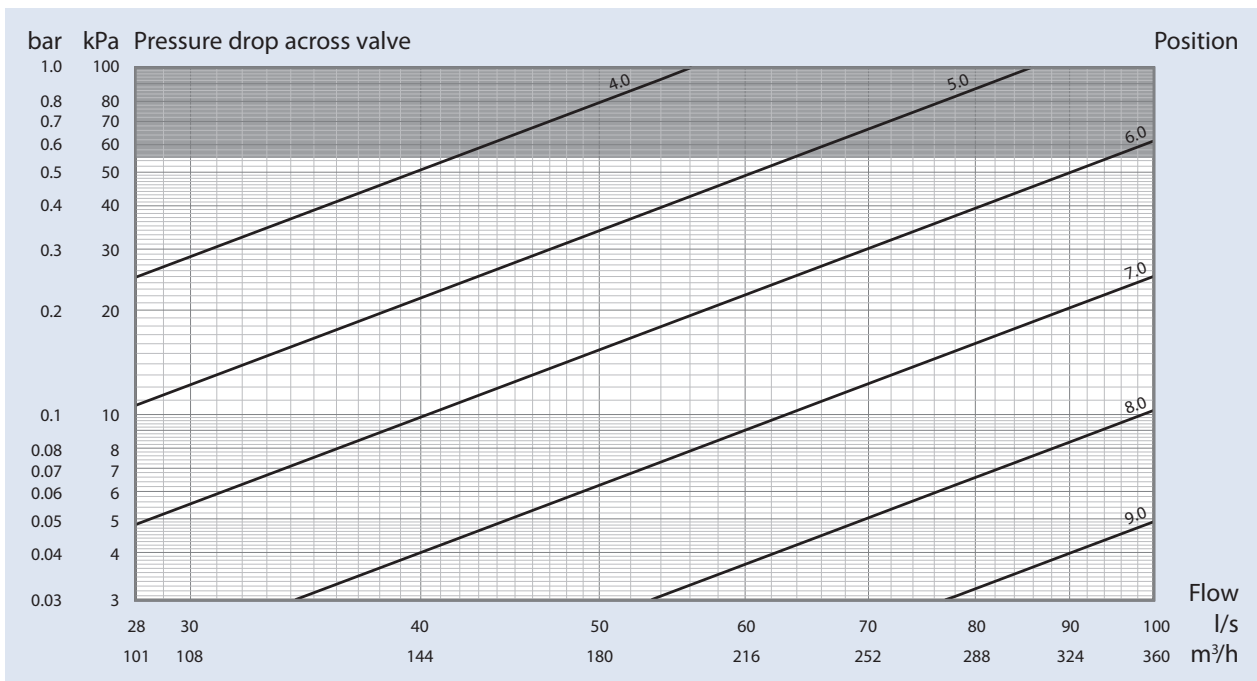

DN 250

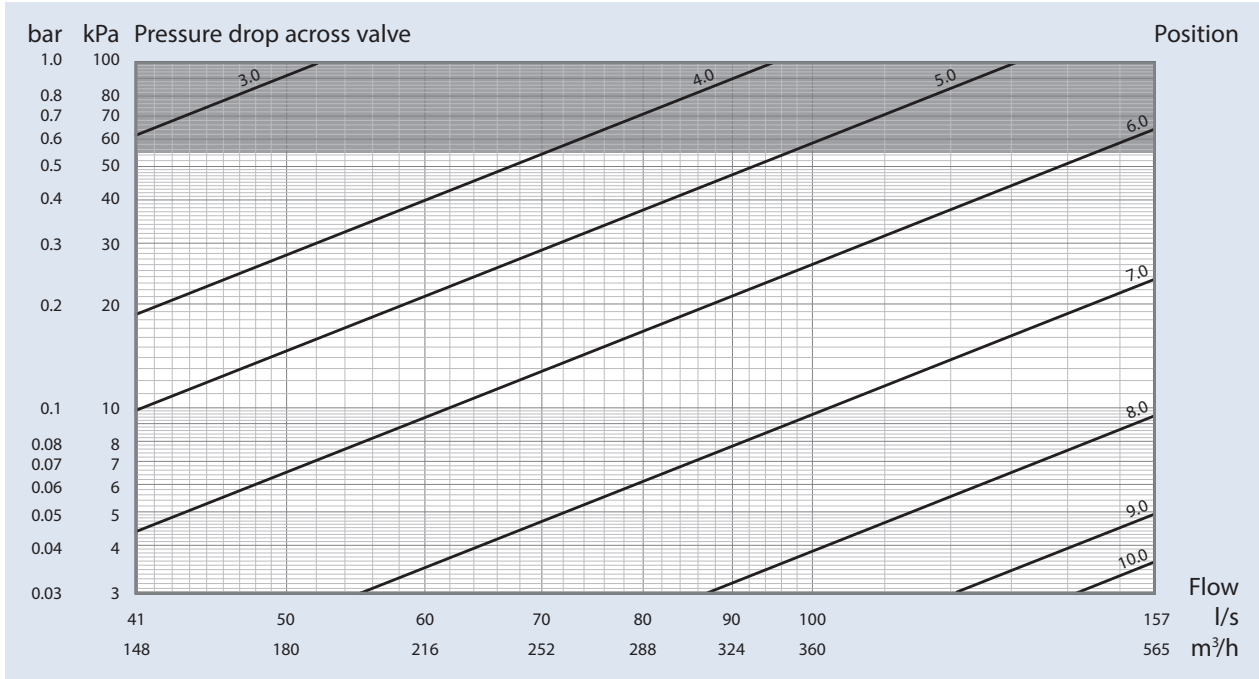

DN 300

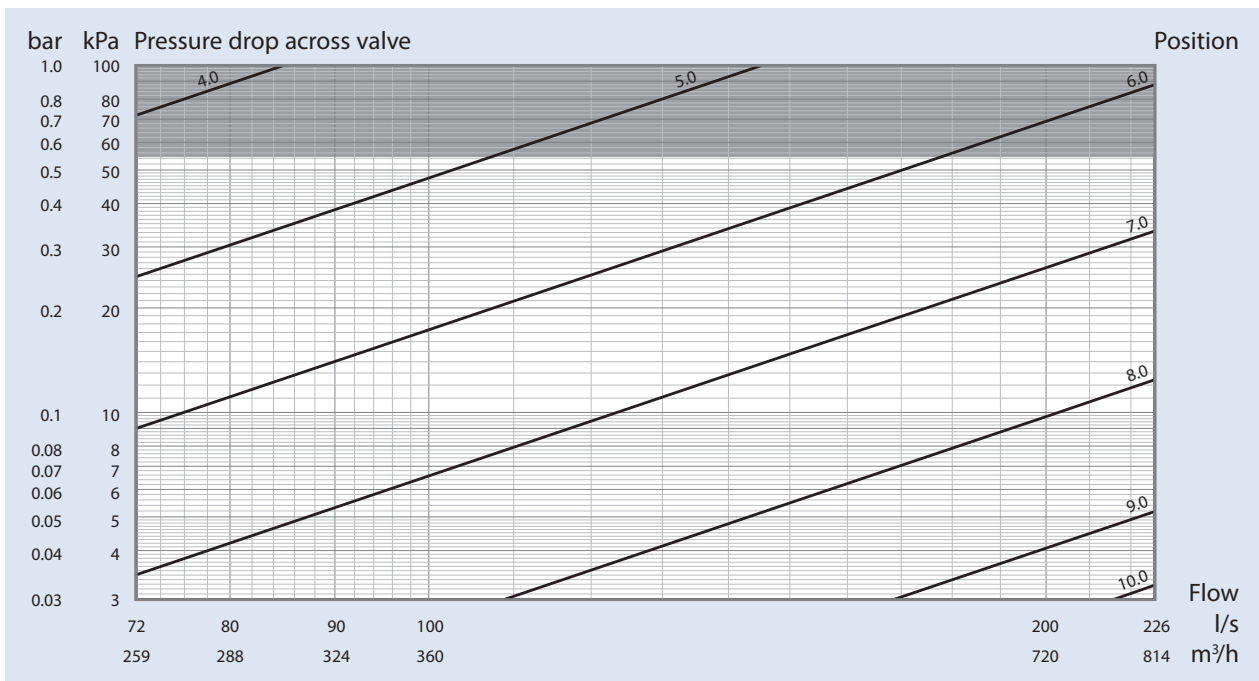

4. Product data sheet

4.5 Measuring signal diagrams

The red dash-dot line shows the Fluctus measuring signal – the differential pressure across the Venturi nozzle at a given flow. The pressure loss across the Venturi nozzle is in combination with the Kvm value of the valve used to provide the direct flow reading using a flowmeter during system commissioning.

DN 15UL - Ultra low flow

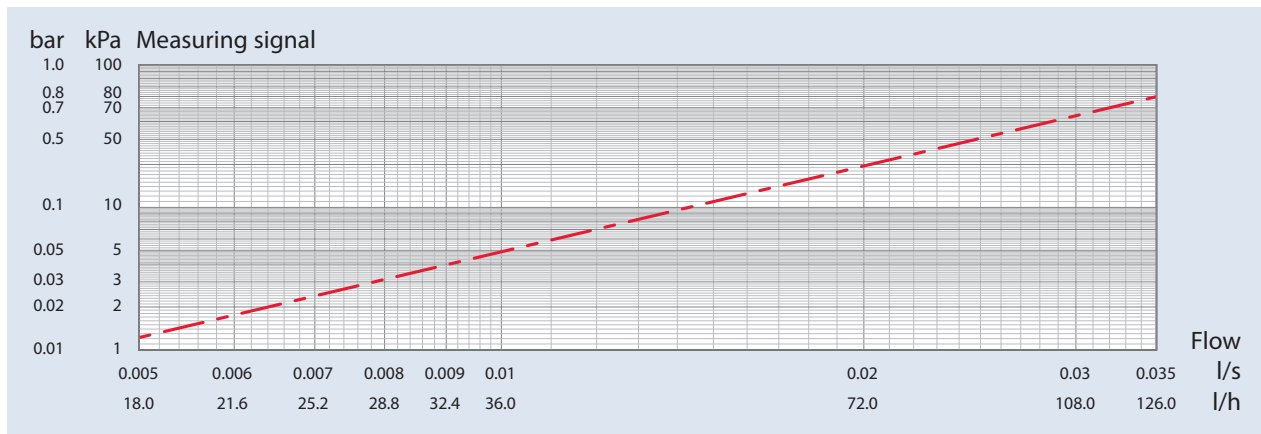

DN 15L - Low flow / DN 15S - Standard flow

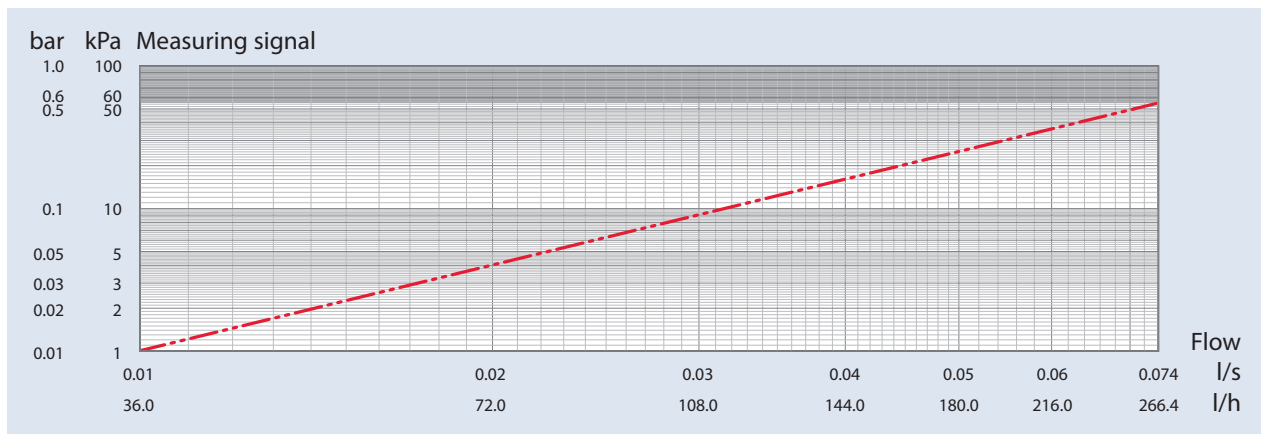

DN 15S - Standard flow

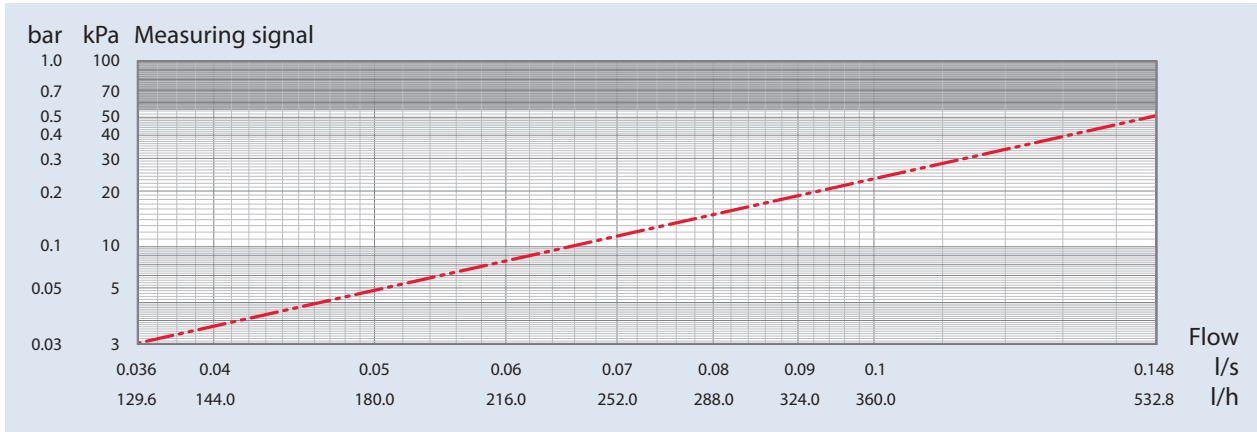

DN 15H - High flow

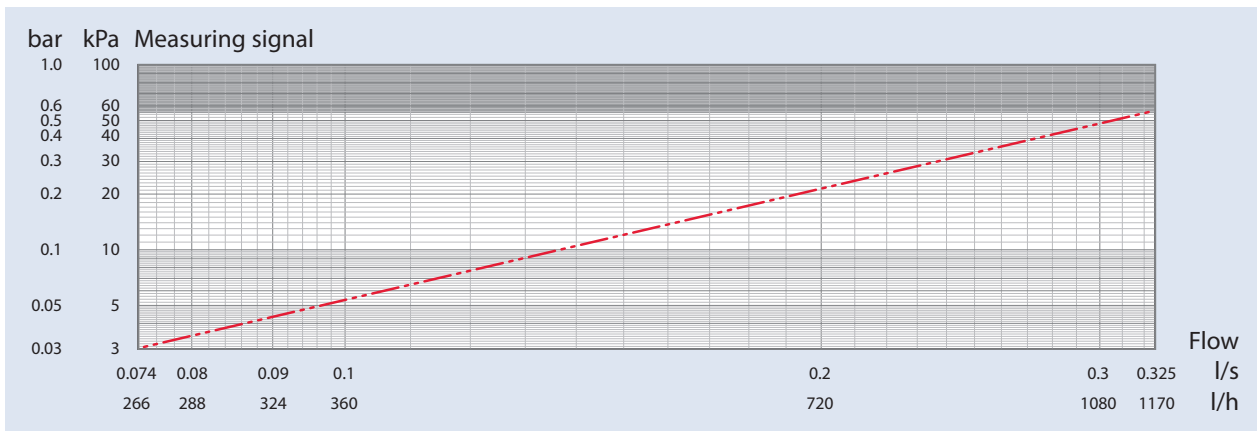

DN 20L - Low flow

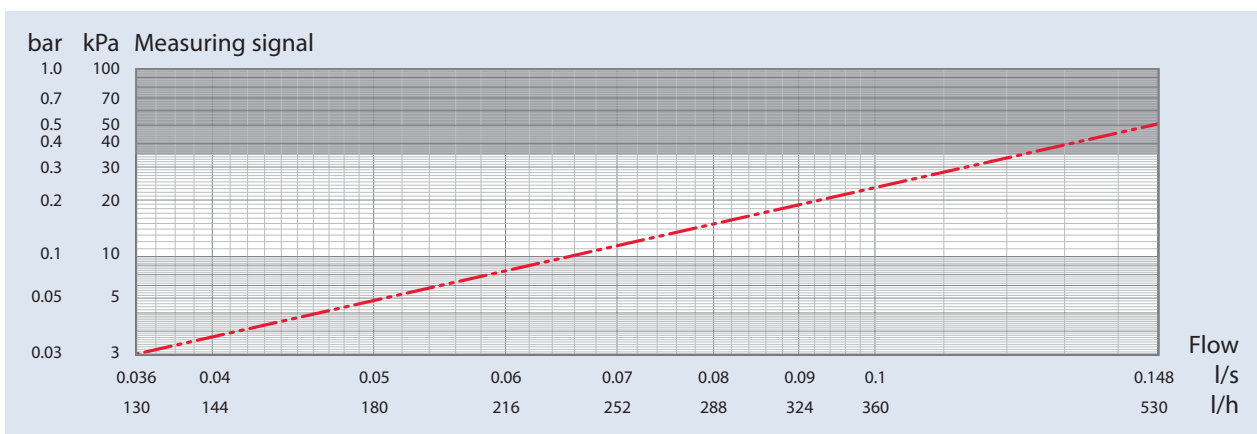

4. Product data sheet

DN 20S - Standard flow

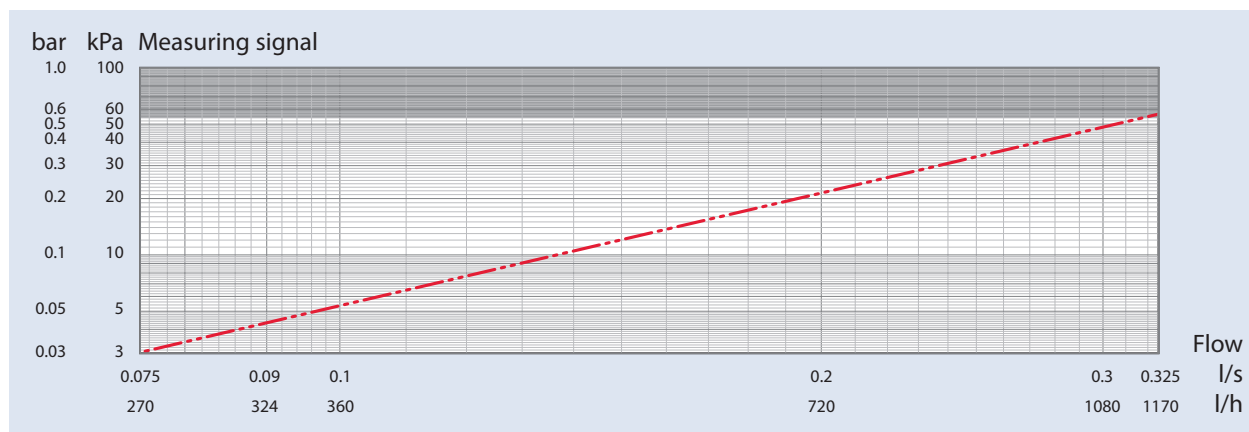

DN 20H - High flow

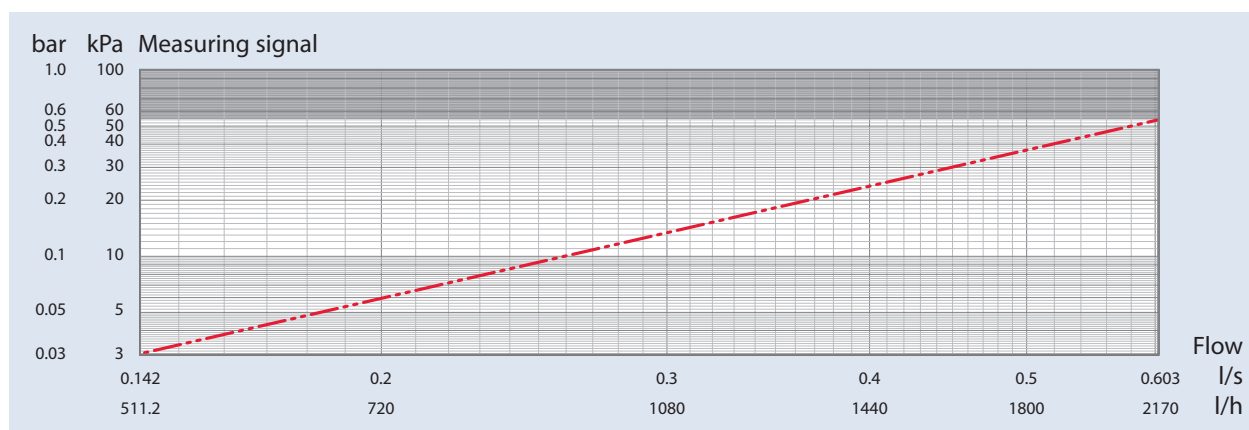

DN 25S - Standard flow

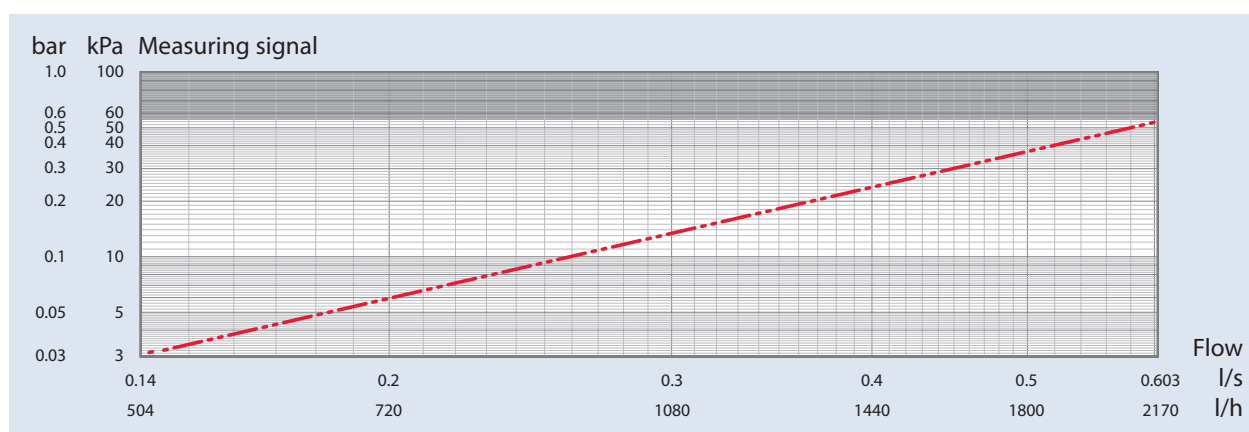

DN 25H - High flow

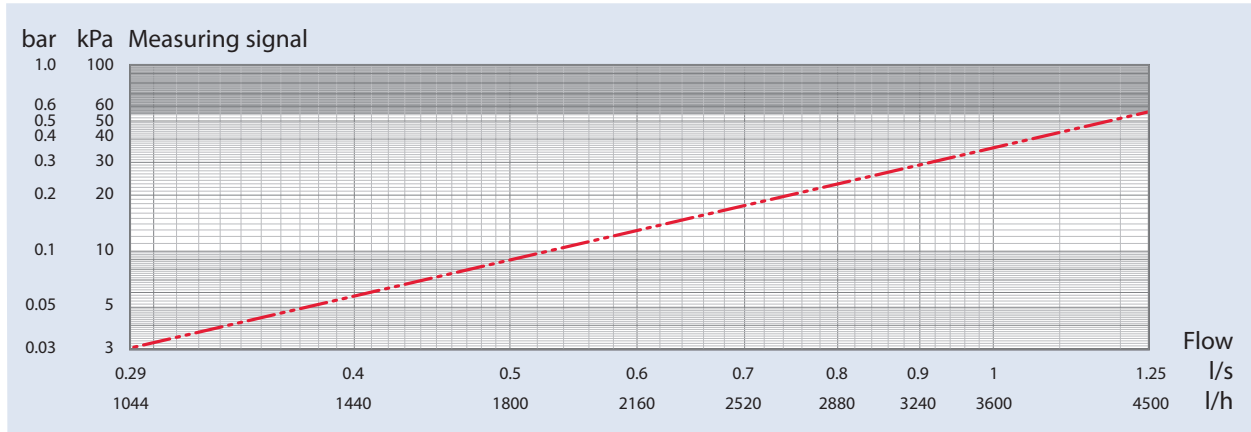

DN 32H - High flow

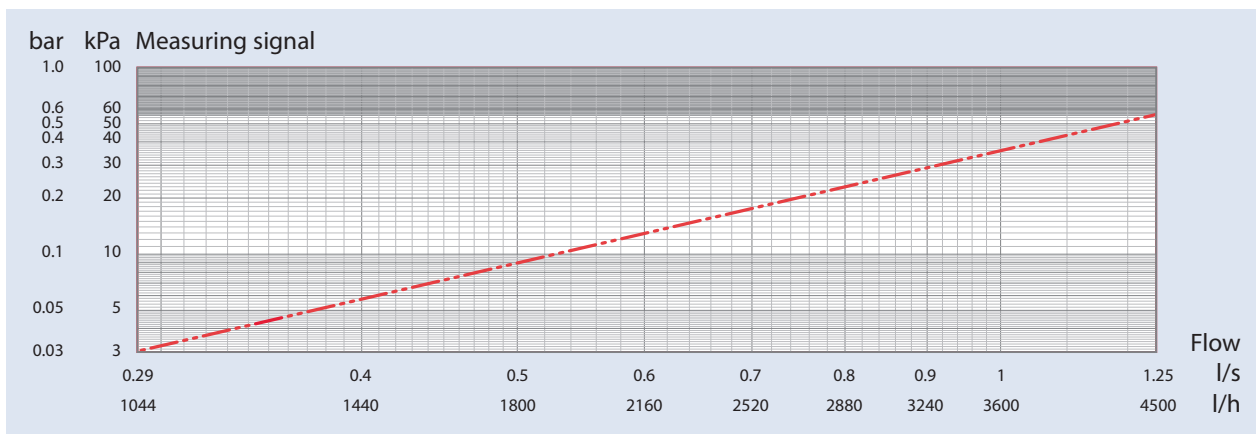

DN 40H - High flow

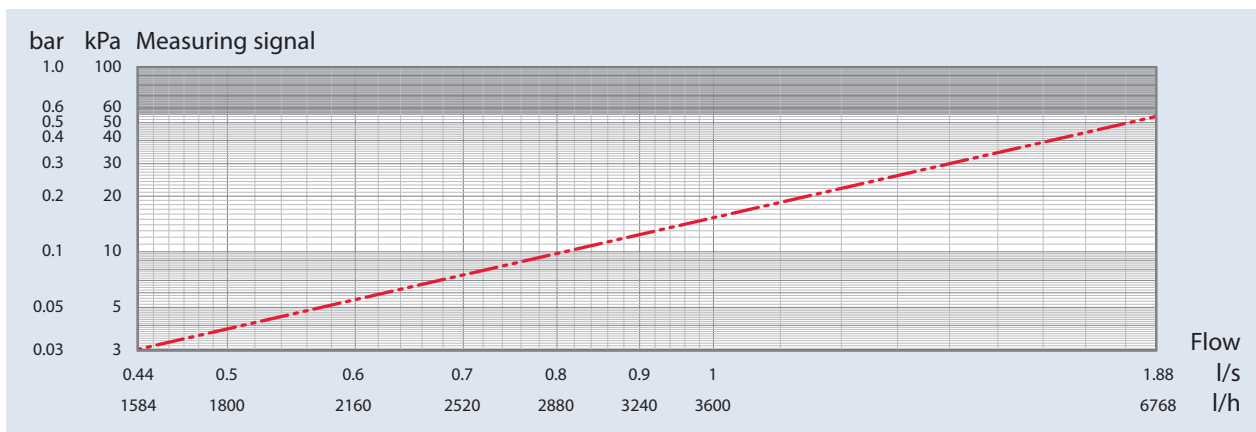

4. Product data sheet

DN 50H - High flow

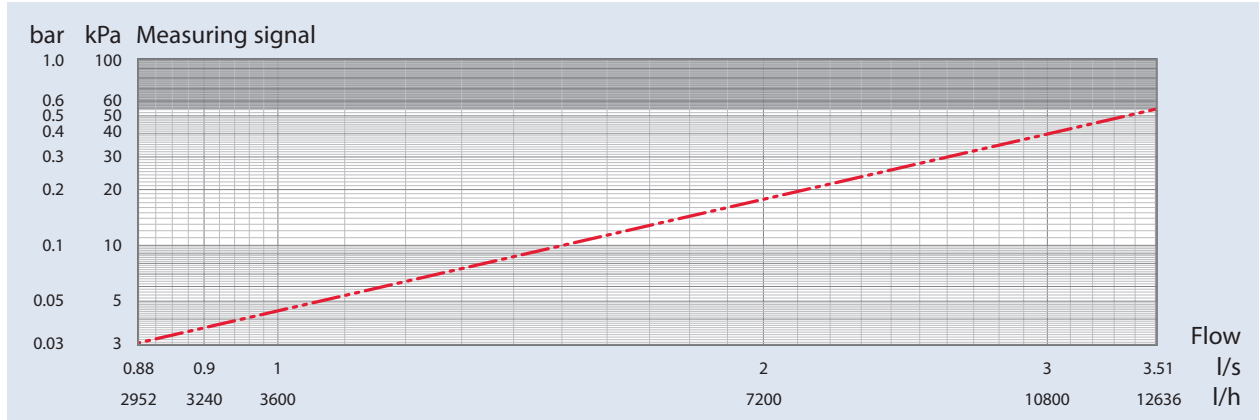

DN 65

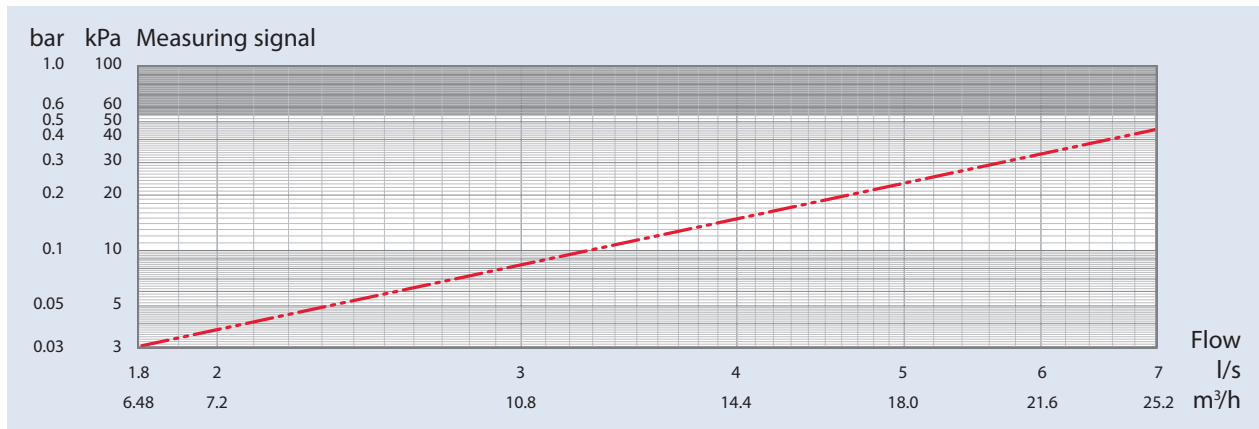

DN 80

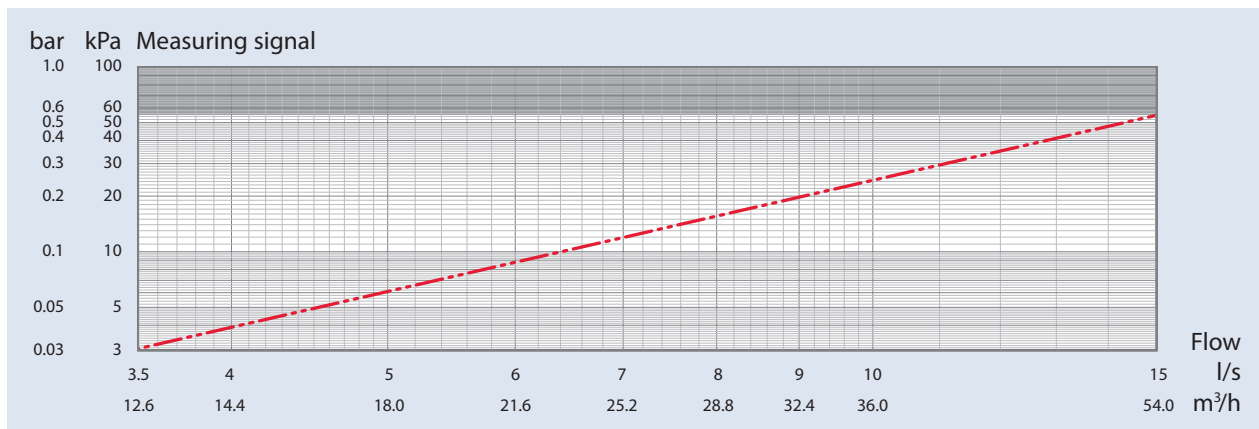

DN 100

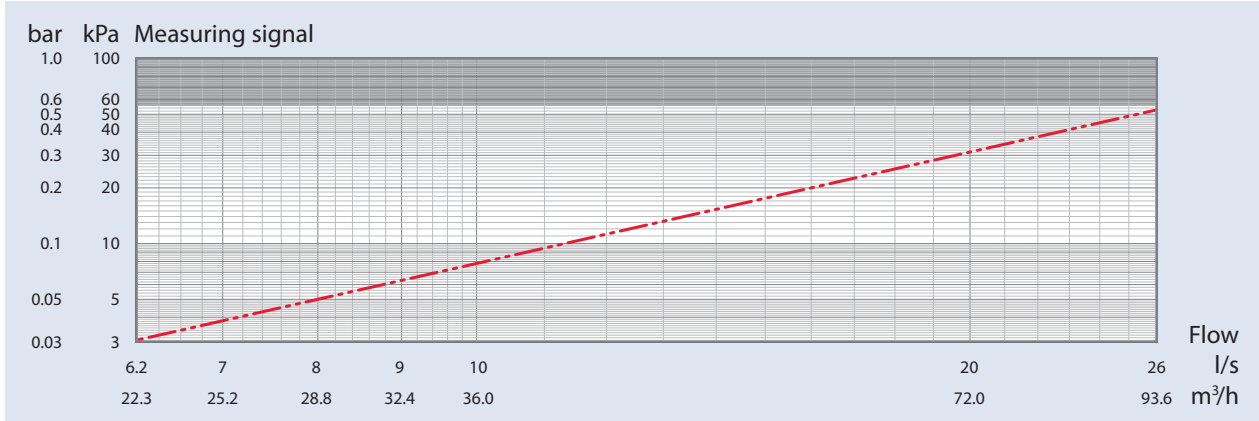

DN 125

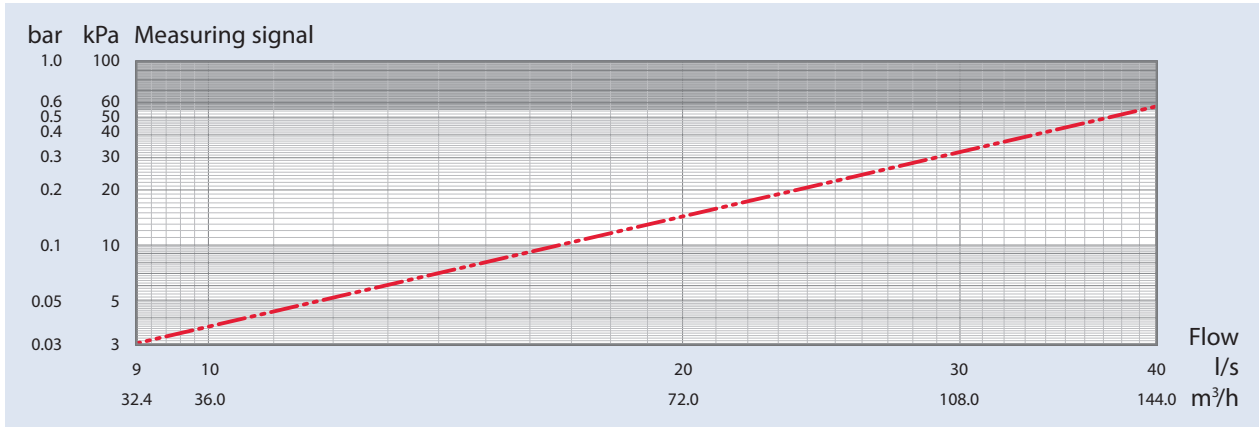

DN 150

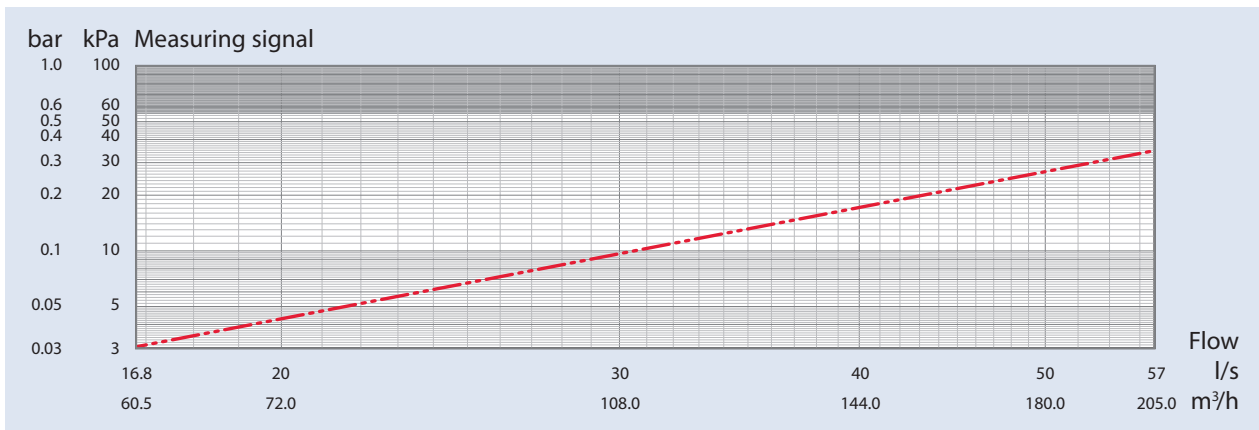

4. Product data sheet

DN 200

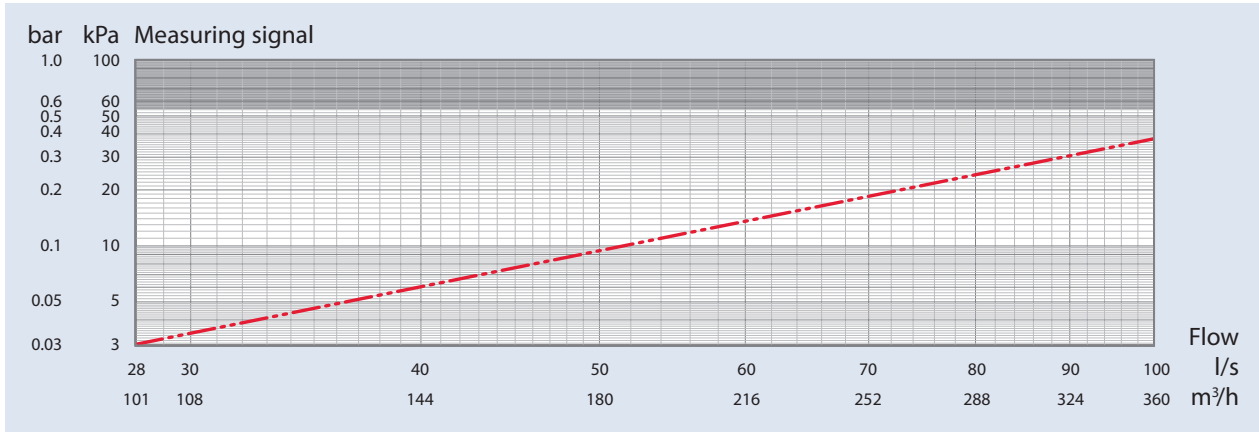

DN 250

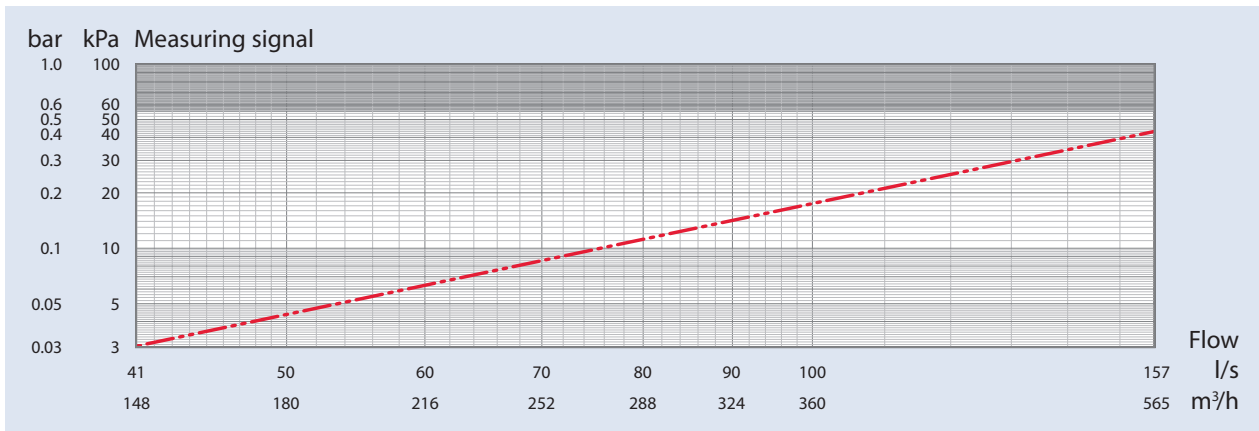

DN 300

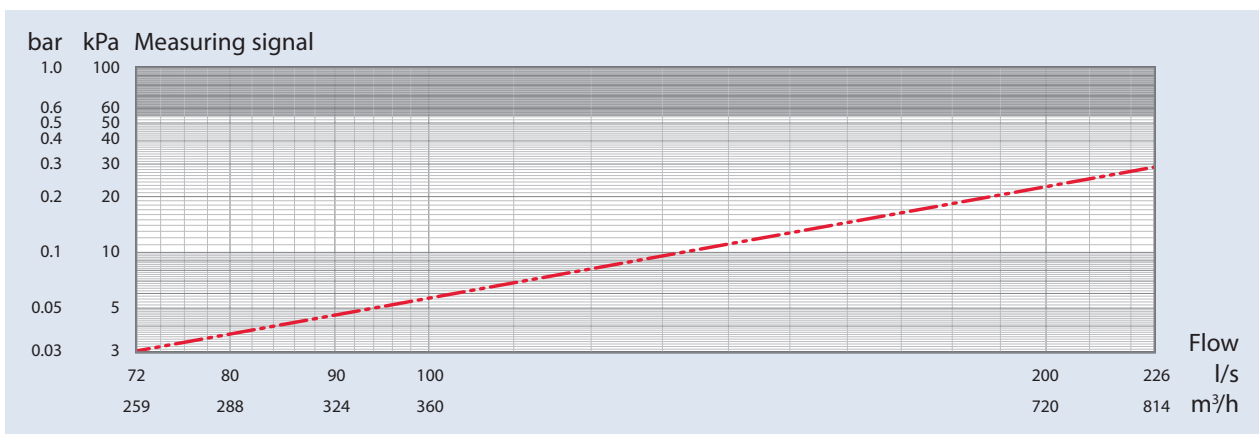

DN 350

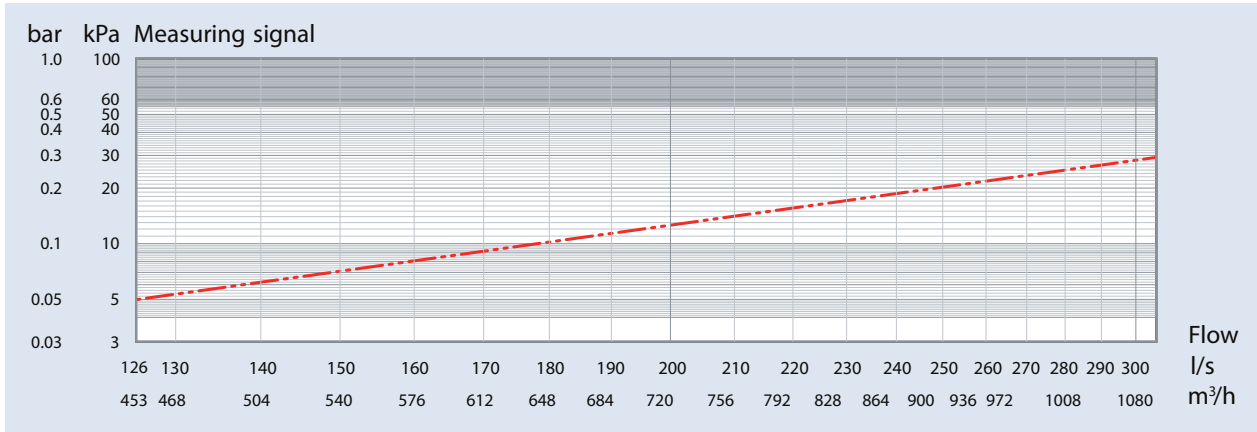

DN 400

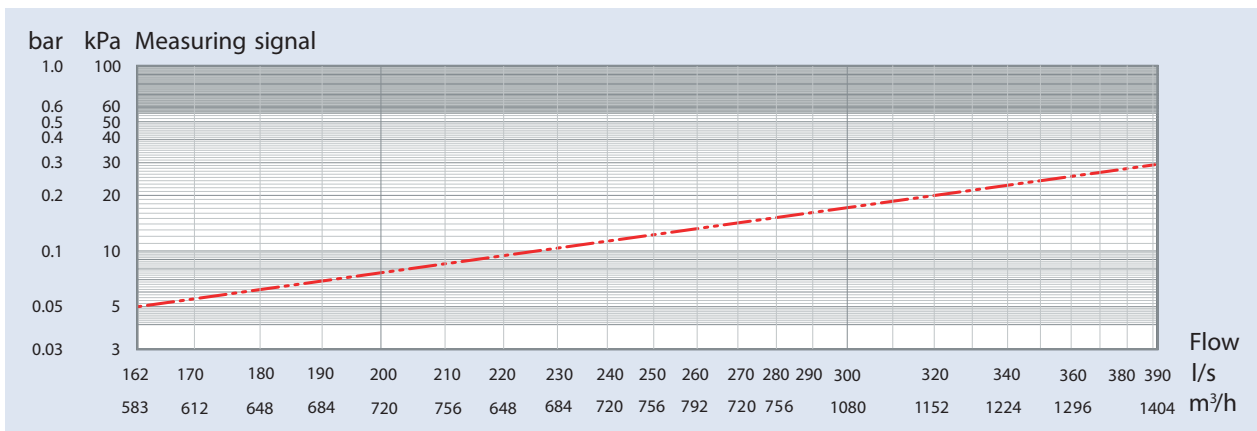

DN 450

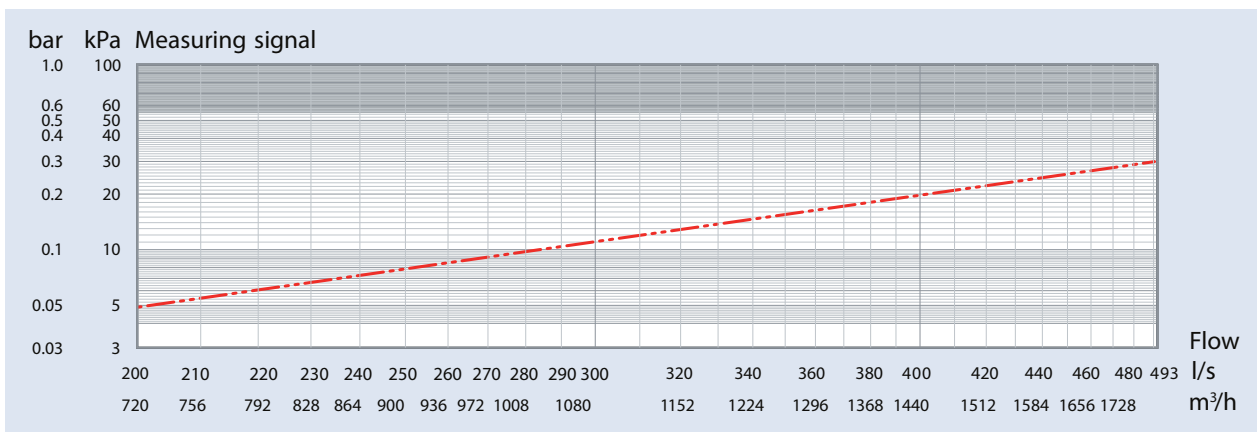

4. Product data sheet

DN 500

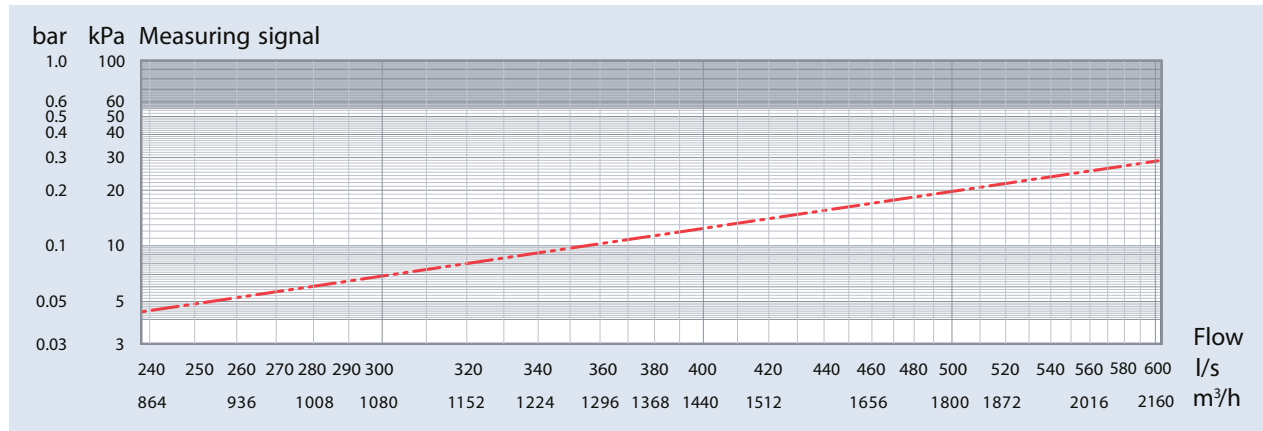

DN 600

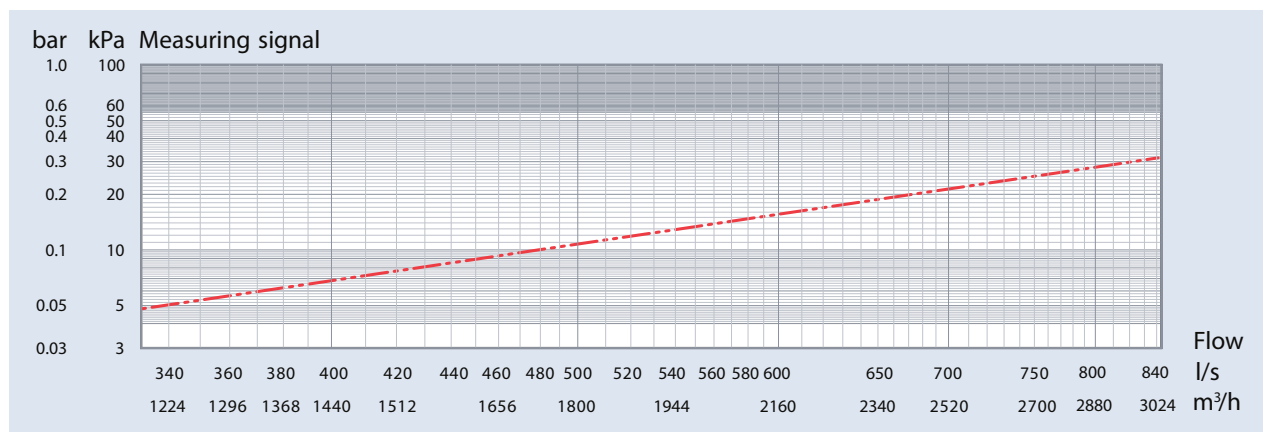

5. Accessories

NexusValve Fluctus accessories

Accessories	Article	Dimension	Description
	MN80597.4007	DN15	Insulation jackets for NexusValve Fluctus Material: expanded polypropylene Color: anthracite Thermal conductivity: 0,035 W/mK at 10°C Application: up to 110°C Fire protection class: B2, DIN 4102 and E, EN 13501-1
	MN80597.4008	DN20	
	MN80597.4009	DN25	
	MN80597.4010	DN32	
	MN80597.4017	DN40	
	MN80597.4018	DN50	
	MN80597.0001	15 mm × 1/2"	Pre-sealed press adaptors (2 pcs) for valve DN 15-50, max. 16 bar
	MN80597.0002	18 mm × 1/2"	
	MN80597.0003	15 mm × 3/4"	
	MN80597.0004	18 mm × 3/4"	
	MN80597.0005	22 mm × 3/4"	
	MN80597.0006	28 mm × 1"	
	MN80597.0007	35 mm × 1 1/4"	
	MN80597.0008	42 mm × 1 1/2"	
	MN80597.0009	54 mm × 2"	
	MN80597.0205	DN15	High capacity drain valve (Kvs = 4.5 m ³ /h), female/female threaded connection (installed in a pipe of the system)
	MN80597.0206	DN20	
	MN80597.0207	DN25	
	MN80597.4033	M14 x 1 / quick coupling	Measuring point for medium temperature up to 150°C. Can be mounted in the P/T port of the NexusValve valves DN 15–50 (when mounted in the valves the maximum operating temperature is 135°C).
	MN80597.0204	R 1/4" 3/8" UNF measuring point G 3/4" drain	Combi Drain Maxi – drain with measuring point for NexusValve Fluctus DN 65 - 600. The capillary tube from the NexusValve Passim can be connected to the 1/4" coupling delivered along with the Combi Drain Maxi and installed on the drain. The maximum operating temperature is 120°C. Can be mounted directly in the pipe of the system.

6. Sizing examples

6.1 NexusValve Fluctus system sizing

Four NexusValve Fluctus valves are installed in a system branch with fan coils. The NexusValve Fluctus valves provide the required flow distribution in the branch, whereas the motorized valves connected to a BMS system or room thermostats control the indoor air temperature.

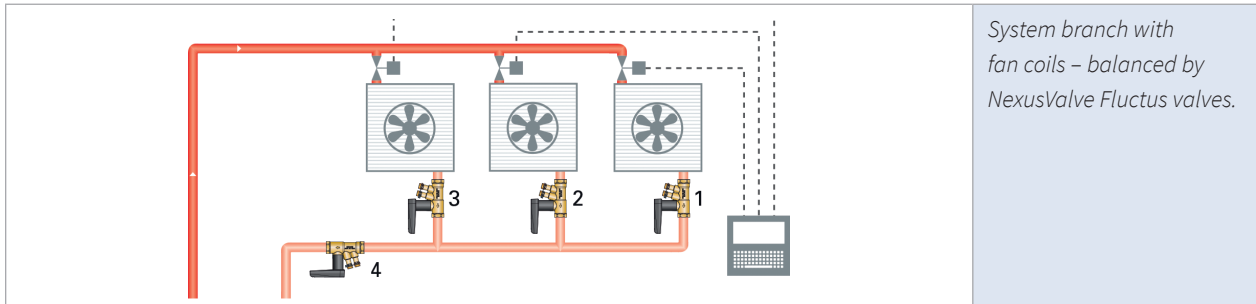

The fan coil flows are specified according to the sizing conditions:

- NexusValve Fluctus No. 1: required flow 0.10 l/s (360 l/h)
- NexusValve Fluctus No. 2: required flow 0.20 l/s (720 l/h)
- NexusValve Fluctus No. 3: required flow 0.25 l/s (900 l/h)
- NexusValve Fluctus No. 4: required flow 0.55 l/s (1980 l/h)

The pressure losses have been calculated in the pipes across the fully open motorized valves and the fan coils. Based on these calculations the following pressure losses across the NexusValve Fluctus valves are required:

- NexusValve Fluctus No. 1: required pressure loss 5.0 kPa
- NexusValve Fluctus No. 2: required pressure loss 7.0 kPa
- NexusValve Fluctus No. 3: required pressure loss 10.0 kPa
- NexusValve Fluctus No. 4: required pressure loss 20.0 kPa

The required valve authority is achieved when valves are sized to the required flow and pressure loss at valves fully open or nearly fully open.

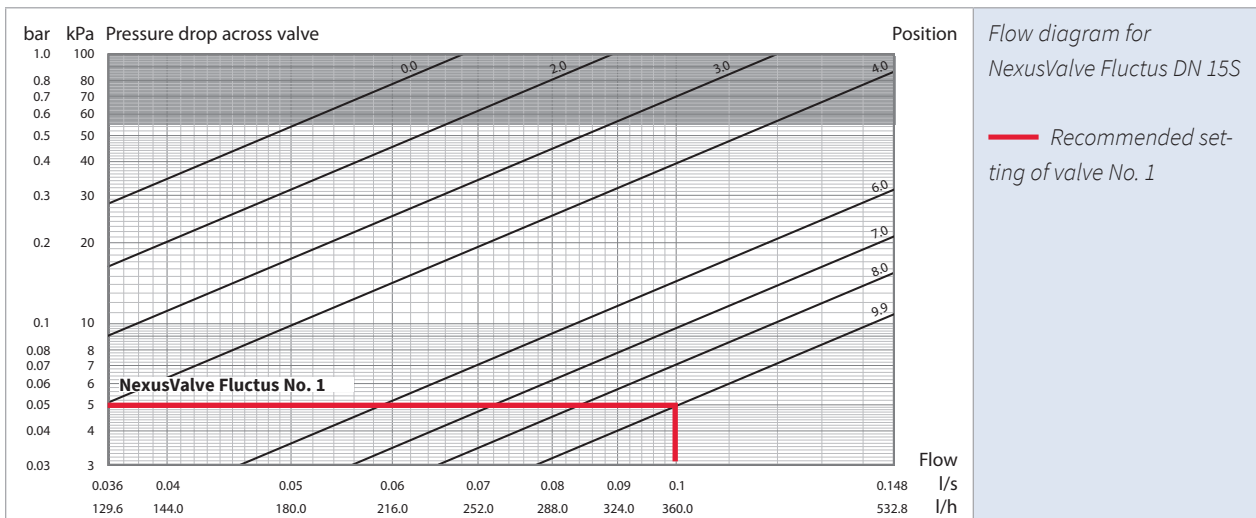

The smallest available NexusValve Fluctus valve fulfilling the requirement is selected for each circuit. In case of DN 15S the pressure loss at the flow of 0.10 l/s and setting 9.9 is 5.0 kPa. This valve will provide good regulation.

A flow of 0.10 l/s is achieved at a setting around 3.6 (55 kPa pressure loss) to 9.9 (5 kPa pressure loss) on a NexusValve Fluctus DN 15S valve. Compared to a DN 20S valve a flow of 0.1 l/s is achieved at a setting around 1.2 (55 kPa pressure loss) to 5.6 (5 kPa pressure loss).

The NexusValve Fluctus DN 15S setting range for 0.1 l/s flow is $9.9 - 3.6 = 6.3$

The NexusValve Fluctus DN 20S setting range for 0.1 l/s flow is $5.6 - 1.2 = 4.4$

The DN 15S valve is preferred as it is easier to set this valve to the required flow – compared to the DN 20S valve.

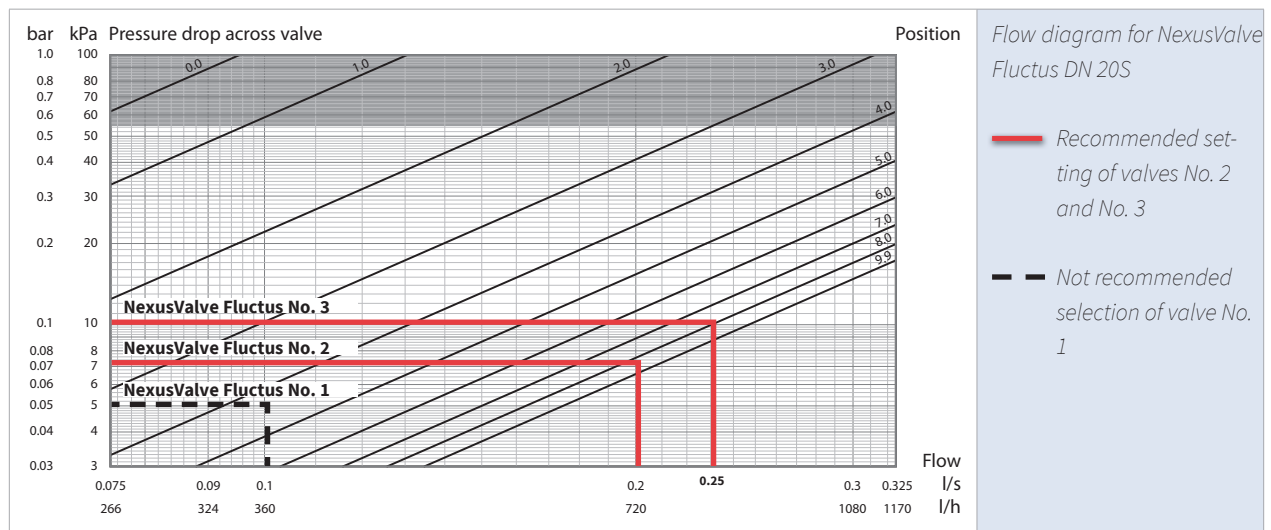

For the 0.20 l/s and 0.25 l/s flows the NexusValve Fluctus DN 20S is selected.

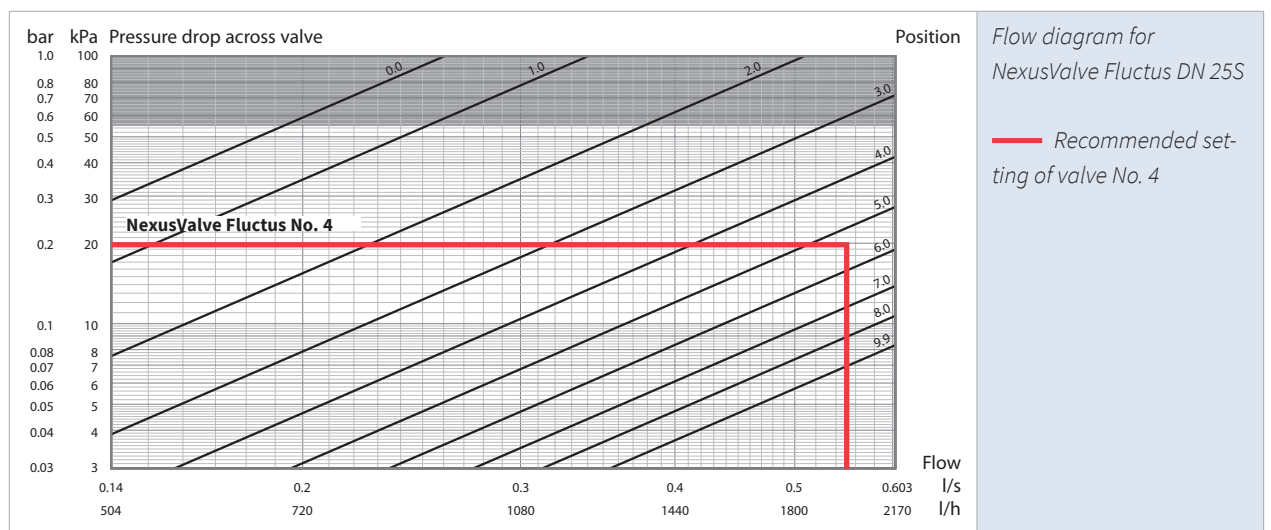

6. Sizing examples

For the 0.55 l/s flow the NexusValve Fluctus DN 25S is selected.

The following setting is provided:

- NexusValve Fluctus No. 1: DN 15S, setting 9.9
- NexusValve Fluctus No. 2: DN 20S, setting 9.5
- NexusValve Fluctus No. 3: DN 20S, setting 9.9
- NexusValve Fluctus No. 4: DN 25S, setting 5.3

Ordering:

- NexusValve Fluctus No. 1, Article No.: MN80597.402
- NexusValve Fluctus No. 2, 3 Article No.: MN80597.405
- NexusValve Fluctus No. 4, Article No.: MN80597.407

6.2 Calculation of flow rates higher than specified in the diagrams

The flow range diagrams are provided in accordance with normative. If higher than in the diagram flow is required over a valve the following procedure should be applied:

1. If more flow is required for instance on valve NexusValve Fluctus DN15S the diagram for the valve should be consulted.
2. The maximum flow can be achieved at valve setting of 9.9.
3. A vertical line from any flow value should be provided to cross the 9.9 setting line.
4. A horizontal line should be provided from the intersection to read the pressure loss.
5. In the example below at flow 360l/h the pressure loss is 5.0kPa.

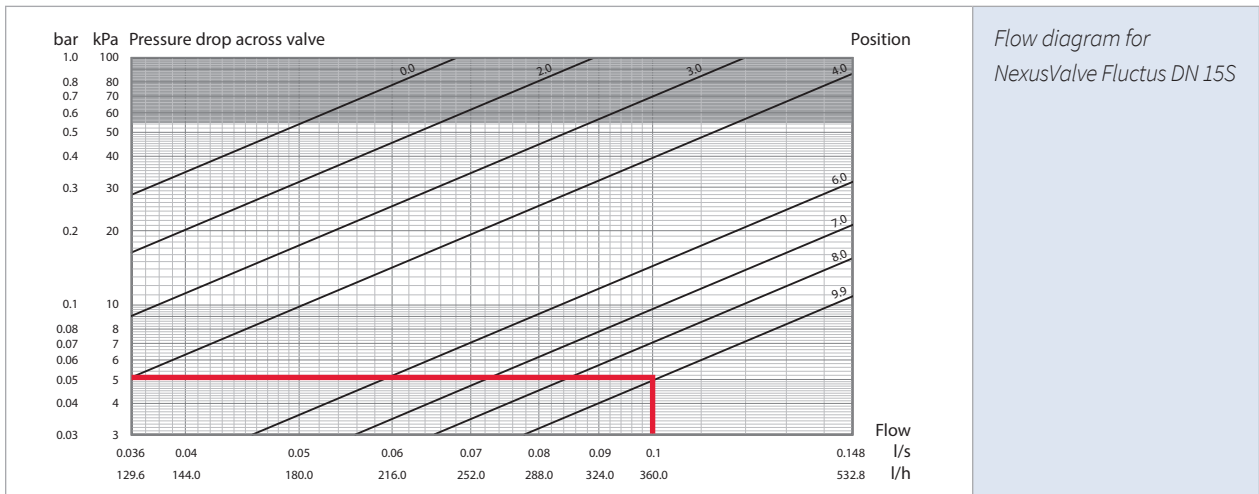

6. The maximum recommended pressure loss over the valve is 55.0 kPa (it is not allowed to exceed 100kPa).
7. The approximate Kv value at setting 9,9 - flow 360 l/h (0.36m³/h) and pressure loss 5.0kPa (0.05bar) is:

$$K_v = \frac{Q[m^3/h]}{\sqrt{\Delta P [bar]}} = \frac{0.36m^3/h}{\sqrt{0.05 bar}} = 1.61 m^3/h$$

The same way Kv value for other valve setting can be calculated (for instance at setting 8.0 the Kv=1,36m³/h).

8. Knowing the approximate Kv value the flow at 55.0kPa (0.55bar) pressure loss over the valve can be calculated:

$$Q=K_v \cdot \sqrt{\Delta P} = 1.61m^3/h \cdot \sqrt{0.55bar} = 0.886 m^3/h$$

This is the maximum flow at setting 9,9 and pressure loss of 55kPa.

9. The same way higher than in the diagram flow can be calculated for all valves DN15-600.

6.3 General specifications DN 15 - 50

1. Balancing valve with Venturi nozzle DN 15 - 50

1.1. The Contractor must install static balancing valves with Venturi nozzle where indicated in drawings.

2. Valve Body

- 2.1. The valve body must be made of hot stamped DR brass CW602N CuZn36Pb2As.
- 2.2. The pressure rating must be no less than PN25.
- 2.3. The valve must have regulation, isolation and flow measurement in one single unit.
- 2.4. A flow arrow must be indicated in valve body.
- 2.5. The regulation handle and the measuring points must be positioned on the same side of the body of the valve.
- 2.6. Testing through the measuring points must be possible in all directions (360°).

3. Flow Regulation

- 3.1. The flow regulation must be externally adjustable using an Allen key.
- 3.2. The regulation settings must remain unchanged when the isolation (open/close function) is re-opened.
- 3.3. Flow measurement must be done across a Venturi nozzle.
- 3.4. Flow measurement must be possible during flow regulation.
- 3.5. Flow accuracy tolerance must be within $\pm 3\%$ across the entire measurement range.
- 3.6. The valve must have no requirements for up- or downstream straight piping.

4. Functions

- 4.1. The valve must have a visible 1/4-turn open/close function.
- 4.2. The valve must have 100 different setting positions.
- 4.3. Kvm value and valve dimensions must be clearly marked on the handle.

6.4 General specifications DN 65 - 600

1. Balancing valve with Fluctus orifice DN 65 - 600

1.1. The Contractor must install static balancing valves with Venturi nozzle where indicated in drawings.

2. Valve Body

- 2.1. The valve body must be made of carbon steel St. 37 and cast iron, fully lugged ASTM A 126 KL.B.
- 2.2. The pressure rating must be no less than PN16 at 105°C (or 120°C).
- 2.3. The valve must have regulation, isolation and flow measurement in one single unit.
- 2.4. A flow arrow must be indicated in valve body.

3. Flow Regulation

- 3.1. Flow regulation must be done using a butterfly valve with gearbox and memory stop.
- 3.2. Flow measurement must be done across a Venturi nozzle.
- 3.3. Flow measurement must be possible during flow regulation.
- 3.4. Flow accuracy tolerance must be within $\pm 3\%$ across the entire measurement range.

Contact

Contact data

www.flamcogroup.com

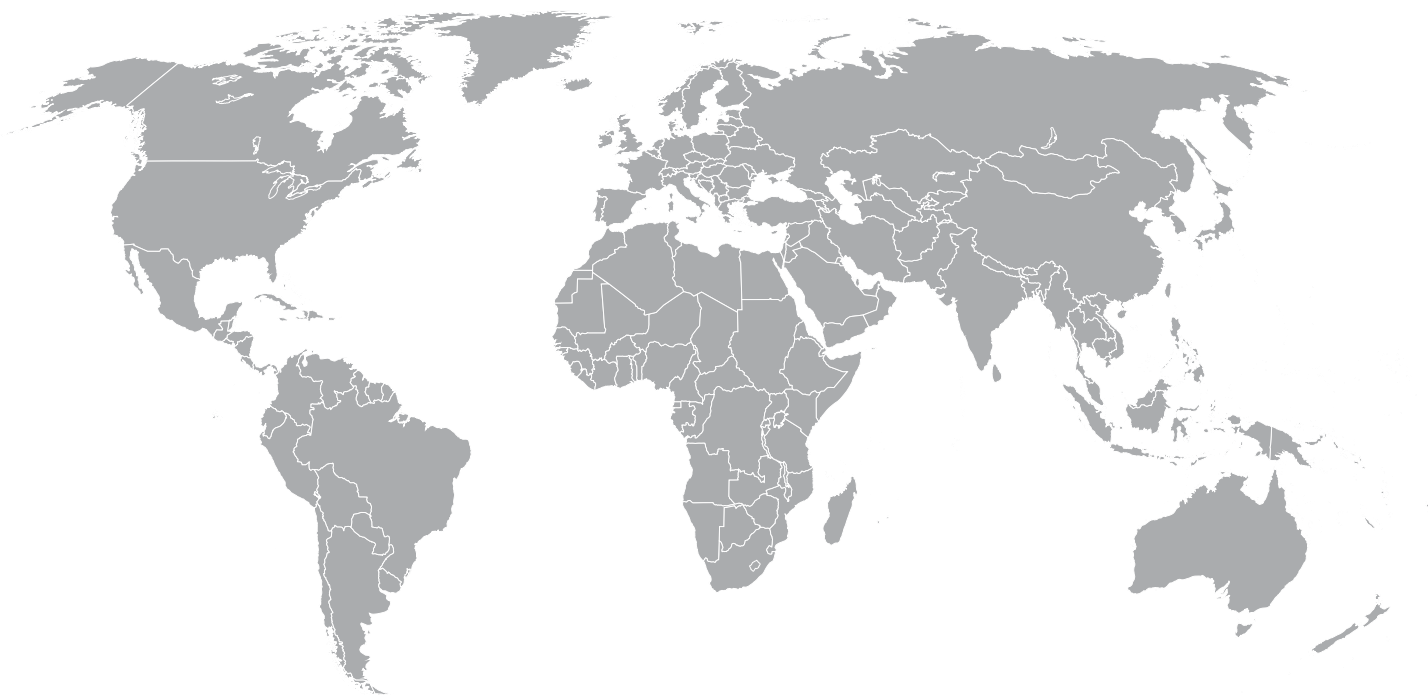

www.flamcogroup.com

the Netherlands

Flamco B.V.
PO Box 502
3750 GM Bunschoten
Amersfoortseweg 9
3751 LJ Bunschoten

T +31 (0)33 299 75 00
E info@flamco.nl
I www.flamcogroup.com

United Kingdom

Flamco UK Ltd
Washway Lane
St Helens, Merseyside
WA10 6PB

T +44 1744 744 744
F +44 1744 744 700
E info@flamco.co.uk
I www.flamcogroup.com

United Arab Emirates

Flamco Middle East
PO Box 262636
Jebel Ali
Dubai

T +971 4 881 95 40
F +971 4 881 95 60
E info@flamco-gulf.com
I www.flamcogroup.com

Subject to modifications

24004.023 Valid since 28-02-2019