

# 10.



## Torurosetid

Kui torustik läbib seina, lae või põrandat, Flamco rosetide paigaldamine tagab seda, et paigaldamine on lõpule viidud professionaalselt ja meeldivalt silmale. Nemed on nii funktsionaalsed, kui ka efektiivsed kuna nad katavad igasuguseid inetuid või ülepuuritud avasid. Nad on elegantse disainiga ja on kättesaadavad eri kujudes ja värvides. Flamco ulatuslik rosetide valik tagab selle lõplikku viimse lihvi.



**STANDARDNE**

Kaunis ja tõhus viis põrandates, seintes ja lagedes olevate toruavade varjamiseks.

- Valmistatud polüpropüleenist.
- Max temperatuur: 120 °C.
- Haarduvate tiibadega, mittelibisevad.

**RK torurosetid**

Värvus: **hall**.  
Klõpskinnisega klamber (aukinnis).

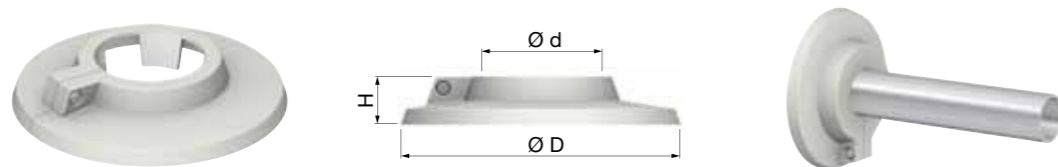

Tüüp	Toru Ø		Mõõdud			Tellimuse kood	
	Nom. ["]	Välisläbimõõt [mm]	Ø d [mm]	H [mm]	Ø D [mm]		
RK 8	-	8	8	12	40	500	12308
RK 1/8	1/8"	10	10	12	40	500	12310
RK 12	-	12	12	12	43	500	12312
RK 1/4	1/4"	14	14	12	40	500	12314
RK 15	-	15	15	12	55	500	12315
RK 16	-	16	16	12	55	500	12316
RK 3/8	3/8"	18	18	12	55	500	12300
RK 20	-	20	20	12	55	500	12320
RK 1/2	1/2"	22	22	12	55	500	12301
RK 25	-	25	25	12	60	500	12325
RK 3/4	3/4"	28	28	12	60	500	12302
RK 1	1"	35	35	12	68	500	12303
RK 1 1/4	1 1/4"	42,9	42,9	12	75	500	12304
RK 1 1/2	1 1/2"	48,8	48,8	12	88	500	12305
RK 57	-	57,6	57,6	12,5	109	500	12357
RK 2	2"	60,8	60,8	12,5	109	500	12306

**RKW torurosetid**

Värvus: **valge**.  
Klõpskinnisega klamber (aukinnis).

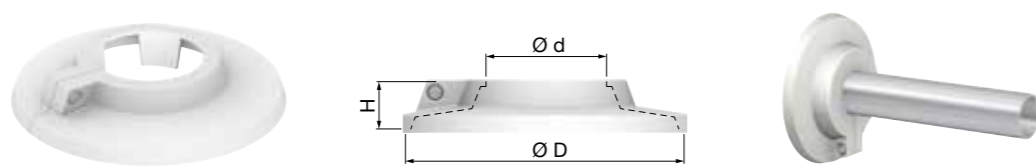

Tüüp	Toru Ø		Mõõdud			Tellimuse kood	
	Nom. ["]	Välisläbimõõt [mm]	Ø d [mm]	H [mm]	Ø D [mm]		
RKW 8	-	8	8,8	12	40	500	12108
RKW 1/8	1/8"	10	10,8	12	40	50	12110
RKW 12	-	12	12,8	12	40	50	12112
RKW 1/4	1/4"	14	14,8	12	55	500	12114
RKW 15	-	15	15,8	12	55	50	12115
RKW 16	-	16	16,8	12	55	500	12116
RKW 3/8	3/8"	18	18,8	12	55	500	12100
RKW 20	-	20	20,8	12	55	500	12120
RKW 1/2 - 22	1/2"	22	22,8	12	60	50	12101
RKW 25	-	25	25	12	60	500	12125
RKW 3/4	3/4"	28	28,8	12	68	500	12102
RKW 1	1"	35	35,8	12	75	500	12103
RKW 1 1/4	1 1/4"	42,9	42,9	12	88	500	12104
RKW 1 1/2	1 1/2"	48,8	48,8	12	95	500	12105
RKW 57	-	57,6	57,6	12,5	105	500	12157
RKW 2	2"	60,8	60,8	12,5	105	500	12106

**RV torurosetid**

Värvus: **valge**.  
Kalasabaseotis.

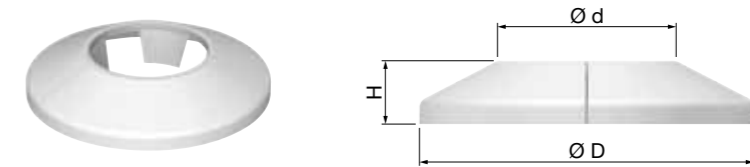

Tüüp	Toru Ø		Mõõdud			Tellimuse kood	
	Nom. ["]	Välisläbimõõt [mm]	Ø d [mm]	K [mm]	Ø D [mm]		
RV 1/8	1/8"	10	10	11,6	40	500	12410
RV 12	-	12	12	11,6	42	500	12412
RV 15	-	15	15	11,6	45	500	12415
RV 3/8	3/8"	18	18	11,6	48	500	12400
RV 1/2	1/2"	22	22	11,3	52	500	12401
RV 3/4	3/4"	28	28	11,3	52	500	12404

**RVC torurosetid**

**kroomitud**.  
Kalasabaseotis.

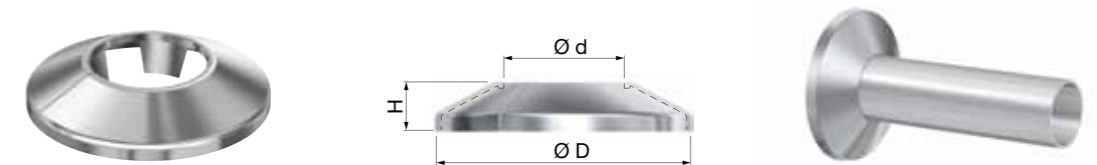

Tüüp	Toru Ø		Mõõdud			Tellimuse kood	
	Nom. ["]	Välisläbimõõt [mm]	Ø d [mm]	H [mm]	Ø D [mm]		
RVC 1/8	1/8"	10	10	11,6	40	500	12460
RVC 12	-	12	12	11,6	42	500	12462
RVC 15	-	15	15	11,6	45	500	12465
RVC 3/8	3/8"	18	18	11,6	48	500	12450
RVC 1/2	1/2"	22	22	11,3	52	500	12451
RVC 3/4	3/4"	28	28	11,3	52	500	12454

**KAHEKORDSED TORUROSETID**

Kaunis ja tõhus viis põrandates, seintes ja lagedes olevate toruavade varjamiseks.

- Valmistatud polüpropüleenist.
- Max temperatuur: 120 °C.

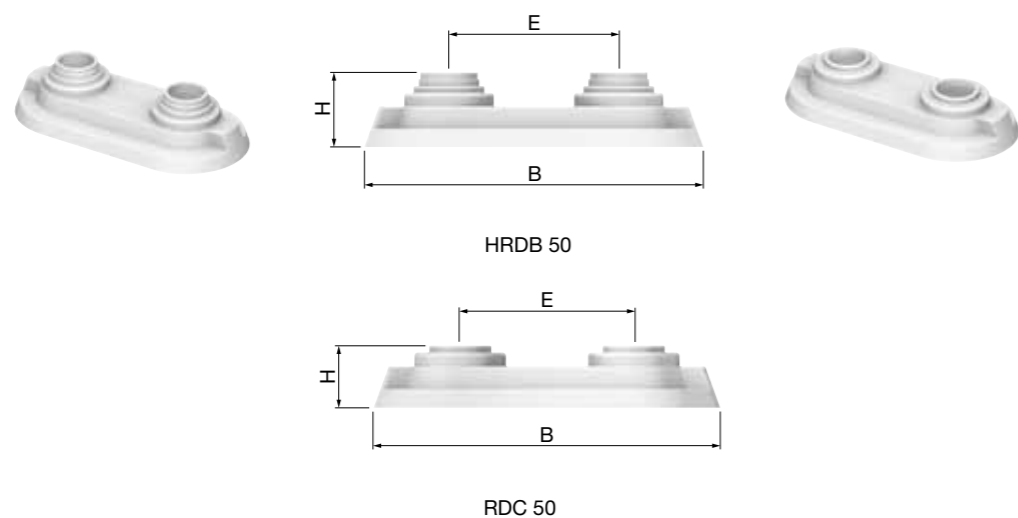
**HRDB/RDC kahekordsed torurosetid**

Tüüp	Toru Ø välisläbimõõt [mm]	Mõõdud			Tellimuse kood
		B [mm]	H [mm]	E [mm]	
HRDB 50	14, 16, 17, 20	99	20	50	12550
RDC 50	-	99	18	50	12555

**RD kahekordsed torurosetid**

Värvus: valge.

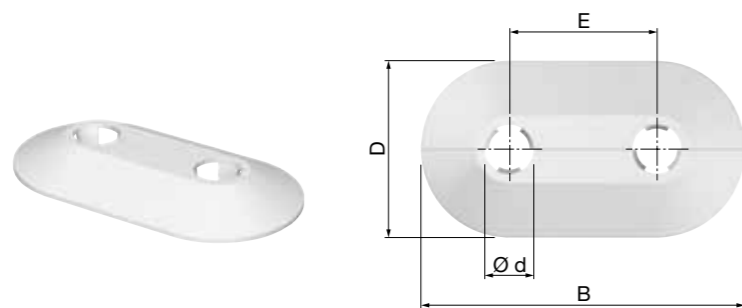

Tüüp	Toru Ø välisläbimõõt [mm]	Mõõdud				Tellimuse kood
		Ø d [mm]	B [mm]	D [mm]	E [mm]	
RVD 15/50	15	15	110	60	50	12569
RVD 16/50	16	16	110	60	50	12570

**RVDC kahekordsed torurosetid**

Kroomitud.

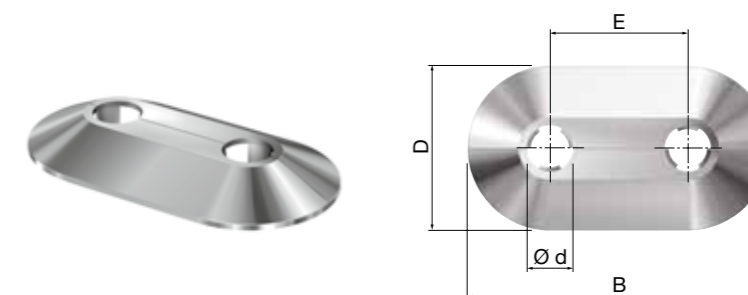

Tüüp	Toru Ø välisläbimõõt [mm]	Mõõdud				Tellimuse kood
		Ø d [mm]	B [mm]	D [mm]	E [mm]	
RVDC 15/50	15	15	110	60	50	12529