

15.

Roestvaststaal bevestigingen

Flamco heeft een breed assortiment RVS montagemateriaal, dat standaard bestaat uit RVS 304 en RVS 316.

Verzinkt staal is prima geschikt voor de meeste werktuigbouwkundige toepassingen zoals installaties voor centrale verwarming of koeling. In industriële installaties en in de voedingsmiddelenindustrie geldt montagemateriaal van RVS-kwaliteit meestal als standaard.

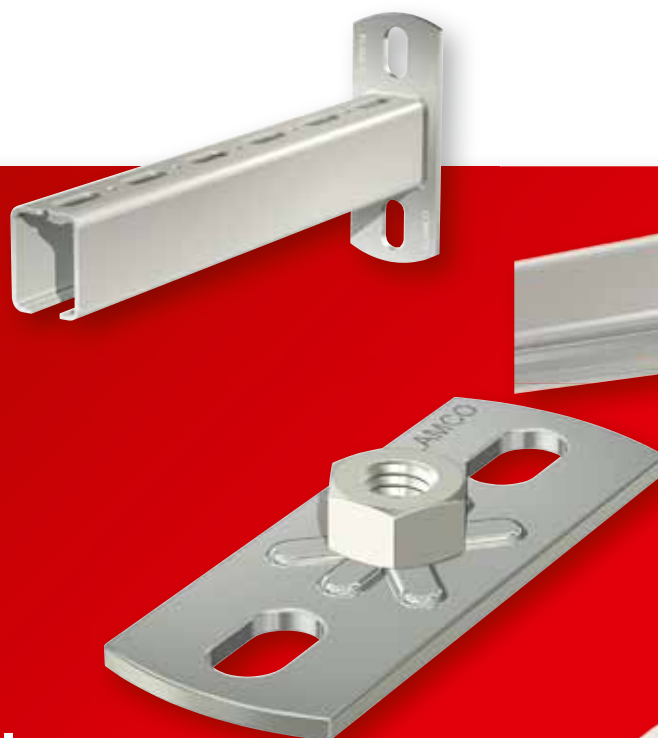



RVS BEUGELS

BRS - RVS beugels M 8/10

- Voorzien van een RVS combimoer M 8/10.
- Korte inbouwmaat.
- RVS 316 (1.4401 volgens EN 10088).



Type	Ø Buis		Band-afmeting [mm]	Max. werk-belasting [N]		Code-nummer
	Nom. ["]	Uitwendig [mm]				
BRS 8 - 10	1/8"	8 - 10	20 / 1,5	1000	50	38475
BRS 12 - 14	1/4"	12 - 14	20 / 1,5	1000	50	38476
BRS 15 - 19	3/8"	15 - 19	20 / 1,5	1000	50	38477
BRS 20 - 25	1/2"	20 - 25	20 / 1,5	1000	50	38478
BRS 26 - 30	3/4"	26 - 30	20 / 1,5	1000	50	38479
BRS 32 - 36	1"	32 - 36	20 / 1,5	1000	50	38480
BRS 38 - 43	1 1/4"	38 - 43	20 / 1,5	1000	50	38481
BRS 44 - 49	1 1/2"	44 - 49	20 / 1,5	1000	50	38482
BRS 50 - 55	-	50 - 55	20 / 1,5	1000	50	38483
BRS 56 - 61	2"	56 - 61	20 / 1,5	1000	50	38484
BRS 62 - 67	-	62 - 67	20 / 2,0	1000	50	38485
BRS 68 - 73	-	68 - 73	20 / 2,0	1300	50	38486
BRS 75 - 80	2 1/2"	75 - 80	20 / 2,0	1300	50	38487
BRS 82 - 86	3"	82 - 86	20 / 2,0	1300	50	38488
BRS 87 - 92	3"	87 - 92	20 / 2,0	1300	50	38489
BRS 95 - 102	3 1/2"	95 - 102	20 / 2,5	2150	50	38490
BRS 108 - 116	4"	108 - 116	20 / 2,5	2150	25	38491
BRS 121 - 127	-	121 - 127	20 / 2,5	2150	25	38492
BRS 131 - 141	5"	131 - 141	20 / 2,5	2150	25	38493
BRS 159 - 163	-	159 - 163	20 / 2,5	2150	25	38494
BRS 165 - 169	6"	165 - 169	20 / 2,5	2150	25	38495
BRS 192 - 202	-	192 - 202	20 / 3,0	2150	25	38496
BRS 210 - 220	8"	210 - 220	20 / 3,0	2150	25	38497

BRS-A - RVS beugels M 8/10

- Voorzien van een geluiddempende EPDM rubberinlage.
- Voorzien van een RVS combimoer M 8/10.
- Korte inbouwmaat.
- RVS 316 (1.4401 volgens EN 10088).



Type	Ø Buis		Band-afmeting [mm]	Max. werk-belasting [N]		Code-nummer
	Nom. ["]	Uitwendig [mm]				
BRS-A 8 - 10	1/8"	8 - 10	20 / 1,5	1000	50	38450
BRS-A 12 - 14	1/4"	12 - 14	20 / 1,5	1000	50	38451
BRS-A 15 - 19	3/8"	15 - 19	20 / 1,5	1000	50	38452
BRS-A 20 - 25	1/2"	20 - 25	20 / 1,5	1000	50	38453
BRS-A 26 - 30	3/4"	26 - 30	20 / 1,5	1000	50	38454
BRS-A 32 - 36	1"	32 - 36	20 / 1,5	1000	50	38455
BRS-A 38 - 43	1 1/4"	38 - 43	20 / 1,5	1000	50	38456
BRS-A 44 - 49	1 1/2"	44 - 49	20 / 1,5	1000	50	38457
BRS-A 50 - 55	1 3/4"	50 - 55	20 / 1,5	1000	50	38458
BRS-A 56 - 61	2"	56 - 61	20 / 1,5	1000	50	38459
BRS-A 62 - 67	-	62 - 67	20 / 2,0	1300	50	38460
BRS-A 68 - 73	2 1/4"	67 - 73	20 / 2,0	1300	50	38461
BRS-A 75 - 80	2 1/2"	75 - 80	20 / 2,0	1300	50	38462
BRS-A 82 - 86	2 3/4"	82 - 86	20 / 2,0	1300	50	38463
BRS-A 87 - 92	3"	87 - 92	20 / 2,0	1300	50	38464
BRS-A 95 - 102	3 1/2"	95 - 102	20 / 2,5	2150	50	38465
BRS-A 108 - 116	4"	108 - 116	20 / 2,5	2150	25	38466
BRS-A 121 - 127	-	121 - 127	20 / 2,5	2150	25	38467
BRS-A 131 - 141	5"	131 - 141	20 / 2,5	2150	25	38468
BRS-A 159 - 163	6"	159 - 163	20 / 2,5	2150	25	38469
BRS-A 165 - 169	6"	165 - 169	20 / 2,5	2150	25	38470
BRS-A 192 - 202	-	192 - 202	20 / 3,0	2150	25	38471
BRS-A 210 - 220	8"	210 - 220	20 / 3,0	2150	25	38473

BSF - RVS beugels M 10 - G ½ M

- Voorzien van een RVS combimoer M 10 - G ½" M.
- RVS 316 (1.4401 volgens EN 10088).

Type	Ø Buis		Band-afmetingen [mm]	Max. Werk-belasting [N]		Code-nummer
	Nom. ["]	Uitwendig [mm]				
BSF - RVS 13 - 17,5	3/8"	13 - 17,5	20 / 2,5	1650	50	51851
BSF - RVS 21 - 25,5	1/2"	21 - 25,5	20 / 2,5	1650	50	51852
BSF - RVS 26,5 - 30,5	3/4"	26,5 - 30,5	20 / 2,5	1650	50	51853
BSF - RVS 33,5 - 38,5	1"	33,5 - 38,5	20 / 2,5	1650	50	51854
BSF - RVS 41,5 - 47	1 1/4"	41,5 - 47	20 / 2,5	1650	50	51855
BSF - RVS 48 - 54	1 1/2"	48 - 54	20 / 2,5	1650	50	51856
BSF - RVS 56 - 62,5	2"	56 - 62,5	20 / 2,5	1650	50	51857
BSF - RVS 69,5 - 76,5	2 1/2"	69,5 - 76,5	20 / 2,5	1650	50	51859
BSF - RVS 82 - 85	-	82 - 85	25 / 3,0	1650	25	51860
BSF - RVS 89 - 90	3"	89 - 90	25 / 3,0	1650	25	51861
BSF - RVS 99 - 102	-	99 - 102	25 / 3,0	3000	25	51862
BSF - RVS 109 - 112	-	109 - 112	25 / 3,0	3000	25	51863
BSF - RVS 113 - 116	4"	113 - 116	25 / 3,0	3000	25	51864
BSF - RVS 117 - 121	-	117 - 121	25 / 3,0	3000	25	51865
BSF - RVS 125 - 129	-	125 - 129	25 / 3,0	3000	25	51866
BSF - RVS 133 - 135	-	133 - 135	30 / 3,0	4000	25	51867
BSF - RVS 143,5 - 150,5	-	143,5 - 150,5	30 / 3,0	4000	25	51868
BSF - RVS 151,5 - 159,5	-	151,5 - 159,5	30 / 3,0	4000	25	51869
BSF - RVS 163,5 - 171,5	6"	163,5 - 171,5	30 / 3,0	4000	25	51870
BSF - RVS 172,5 - 182	-	172,5 - 182	30 / 3,0	4000	25	51871
BSF - RVS 192,5 - 198	-	192,5 - 198	30 / 3,0	4000	25	51872
BSF - RVS 200	-	200	30 / 3,0	4000	25	51874
BSF - RVS 215 - 220	8"	215 - 220	30 / 3,0	4000	25	51873

**BSA - RVS beugels M 10 - G ½ M**

- Voorzien van een geluiddempende EPDM rubberinlage.
- Voorzien van een RVS combimoer M 10 - G ½" M.
- RVS 316 (1.4401 volgens EN 10088).

Type	Ø Buis		Band-afmetingen [mm]	Max. Werk-belasting 19 dB(A) [N]		Code-nummer
	Nom. ["]	Uitwendig [mm]				
BSA - RVS 14 - 16	-	14 - 16	25 / 1,75	1000	50	51951
BSA - RVS 17 - 19	3/8"	17 - 19	25 / 1,75	1000	50	51952
BSA - RVS 20 - 24	1/2"	20 - 24	25 / 1,75	1000	50	51953
BSA - RVS 25 - 28	3/4"	25 - 28	25 / 1,75	1000	50	51954
BSA - RVS 33 - 37	1"	33 - 37	25 / 1,75	1000	50	51956
BSA - RVS 38 - 42	1 1/4"	38 - 42	25 / 1,75	1000	50	51957
BSA - RVS 44,5 - 49	1 1/2"	44,5 - 49	25 / 1,75	1000	50	51958
BSA - RVS 50 - 54	-	50 - 54	25 / 1,75	1000	50	51959
BSA - RVS 56 - 60	2"	56 - 60	25 / 1,75	1000	50	51960
BSA - RVS 62 - 64	-	62 - 64	25 / 2,75	1750	25	51970
BSA - RVS 75 - 80	2 1/2"	75 - 80	25 / 2,75	1750	25	51972
BSA - RVS 89 - 91	3"	89 - 91	25 / 2,75	1750	25	51974
BSA - RVS 108 - 116	4"	108 - 116	25 / 2,75	1750	25	51977
BSA - RVS 121 - 127	-	121 - 127	25 / 2,75	1750	25	51979
BSA - RVS 159 - 162	-	159 - 162	25 / 2,75	1750	25	51982



RVS RAIL

R. - RVS rail

- Eenvoudige en snelle montage met nastelmogelijkheid.
- RVS 304.



Type	Lengte [m]	Max. werkbelasting [N]		Code-nummer
R 1 - RVS	2	2000	10	50030
R 4 - RVS	2	2500	10	50034

Afmetingen R. - RVS rail

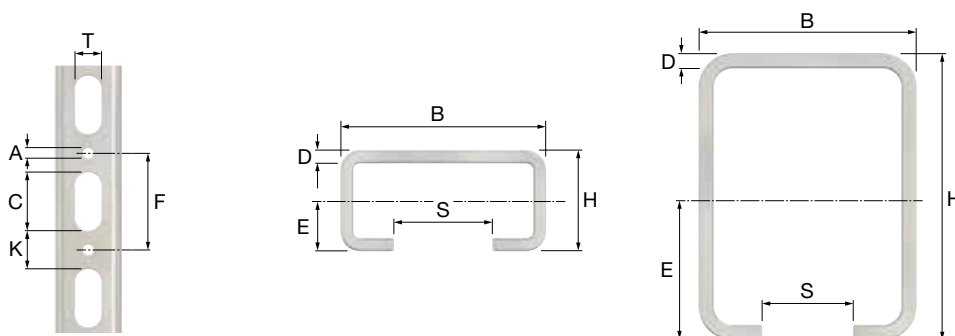

Type	Afmetingen									
	H [mm]	B [mm]	A [mm]	C [mm]	D [mm]	E [mm]	F [mm]	K [mm]	S [mm]	T [mm]
R 1	15	30,5	5,3	30	2,0	8,0	50	20	14,5	10,5
R 4	46	35,0	5,3	30	2,5	23,2	50	20	14,5	13,5

RVS CONSOLES

R. x ... - RVS consoles

- Voor horizontale of verticale bevestiging, ter ondersteuning of voor ophanging.
- Stabiele bevestiging.
- RVS 304.

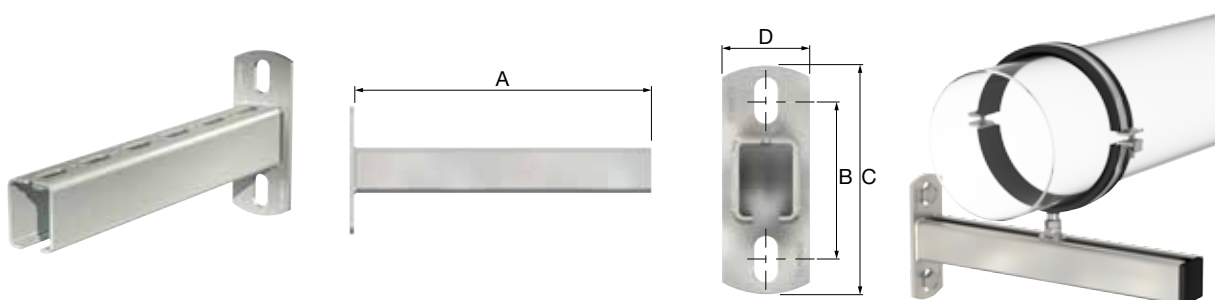



Type	Afmetingen					Code-nummer
	A [mm]	B [mm]	C [mm]	D [mm]		
R 1 x 200 - RVS	200	80	115	40	1	71672
R 1 x 300 - RVS	300	80	115	40	1	71673
R 1 x 400 - RVS	400	80	115	40	1	71674
R 4 x 300 - RVS	300	90	130	50	1	71683
R 4 x 500 - RVS	500	90	130	50	1	71686

RAILDOPPEN

RD raildoppen

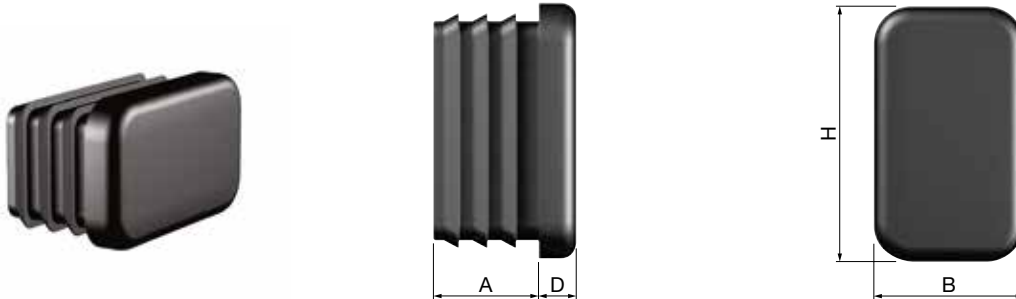
- Zwart polypropyleen.



Type	Geschikt voor rail	Afmetingen					Code-nummer
		A [mm]	B [mm]	D [mm]	H [mm]		
RD 1	R 1	12	15	5	30	100	50501
RD 2	R 2 / R 3	12	20	5	35	100	50502
RD 4	R 4	14	35	5	46	100	50504
RD 6	R 6	14	41	5	60	100	50506
RD 7	R 7	14	40	5	40	100	50507
RD 8	R 8	14	30	5	40	100	50508

RVS BEVESTIGINGSPLATEN

GP - RVS bevestigingsplaten

- Voor het star aan de wand of het plafond monteren van een beugel met draadstang of draadpijp.
- Voorzien van sleufgaten voor een gemakkelijke bevestiging.
- RVS 304.



Type	Draadaansluiting		Code-nummer
GP 8 - 80 x 30 - RVS	M 8	50	39445
GP 10 - 80 x 30 - RVS	M 10	50	39446
GP 1/2 - 80 x 30 - RVS	1/2"	50	39447
GP 10 - 1/2 - 80 x 30 - RVS	M 10 - 1/2"	50	39448

RVS SCHUIFMOEREN

M ..s - RVS schuifmoeren

- Voor het eenvoudig monteren van een ophanging in de Flamco Rail.
- Schuifmoeren en sluitringen kunnen op de plaats van de ophanging in de Flamco Rail worden gekanteld. Daarna een kwartslag draaien en met een moer vastzetten.
- RVS 304.

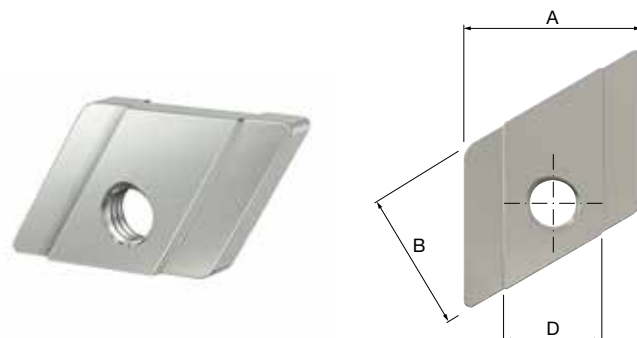

Type	Draadaansluiting	Afmetingen				Code-nummer
		A [mm]	B [mm]	D [mm]		
M 8s - RVS	M 8	25	20	13,5	50	80322
M 10s - RVS	M 10	25	20	13,5	50	80323

RVS SLUITRINGEN

S - RVS sluitringen

- RVS 304.

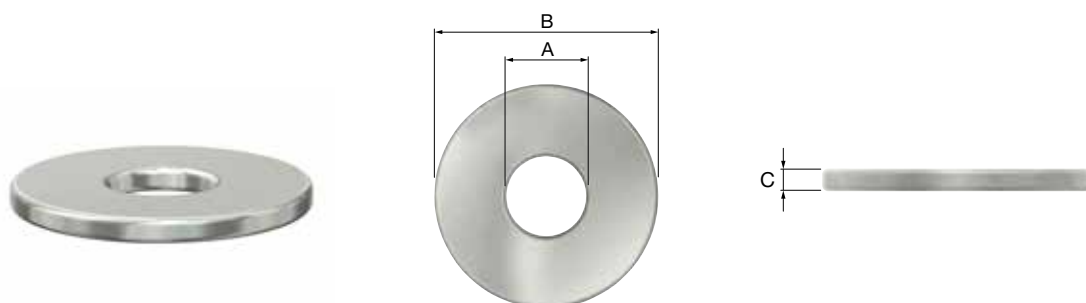

Type	Geschikt voor draadaansluiting (A)	Afmetingen			Code-nummer
		B [mm]	C [mm]		
S 8 - RVS	M 8	18	1,5	100	70822
S 10 - RVS	M 10	22	1,5	100	70823
S 12 - RVS	M 12	28	2,0	50	70824

RVS MOEREN

M - RVS moeren

- RVS 304 (A2 kwaliteit).

Type	Draadaansluiting		Code-nummer
M 8 - RVS	M 8	100	70222
M 10 - RVS	M 10	50	70223
M 12 - RVS	M 12	50	70224



RVS DRAADPRODUCTEN

D - RVS draadstangen

- Voor alle ophangingen en constructies met draadstang.
- Standaardlengte: 1 meter.
- RVS 304.

Type	L. [mm]	Draad-aansluiting	Max. werk-belasting [N]		Code-nummer
D 8 - RVS	1000	M 8	4500	1	70052
D 10 - RVS	1000	M 10	7000	1	70053
D 12 - RVS	1000	M 12	10000	10	70054

**HO - RVS stokschroeven**

- RVS 304.

Type	L. [mm]	Draad-aansluiting		Code-nummer
HO 8 x 60 - RVS	60	M 8	100	70620
HO 8 x 80 - RVS	80	M 8	100	70621
HO 8 x 100 - RVS	100	M 8	100	70624
HO 10 x 80 - RVS	80	M 10	100	70622
HO 10 x 120 - RVS	120	M 10	100	70626
HO 10 x 160 - RVS	160	M 10	100	51755

**RVS moffen**

- RVS 304.

Type	Aansluiting ["]		Code-nummer
Mof 1/2 - RVS	1/2	100	52815

