



Flamco

Flow of Innovation



Flamco Pressurisation Equipment

Flamcomat Balance spill & fill Equipment

Spare part list



Flamco

Flow of Innovation

Contents

Location of parts	3
Spare parts list	4
Not shown items.....	9
Accessories	10
Notes.....	12

Location of parts

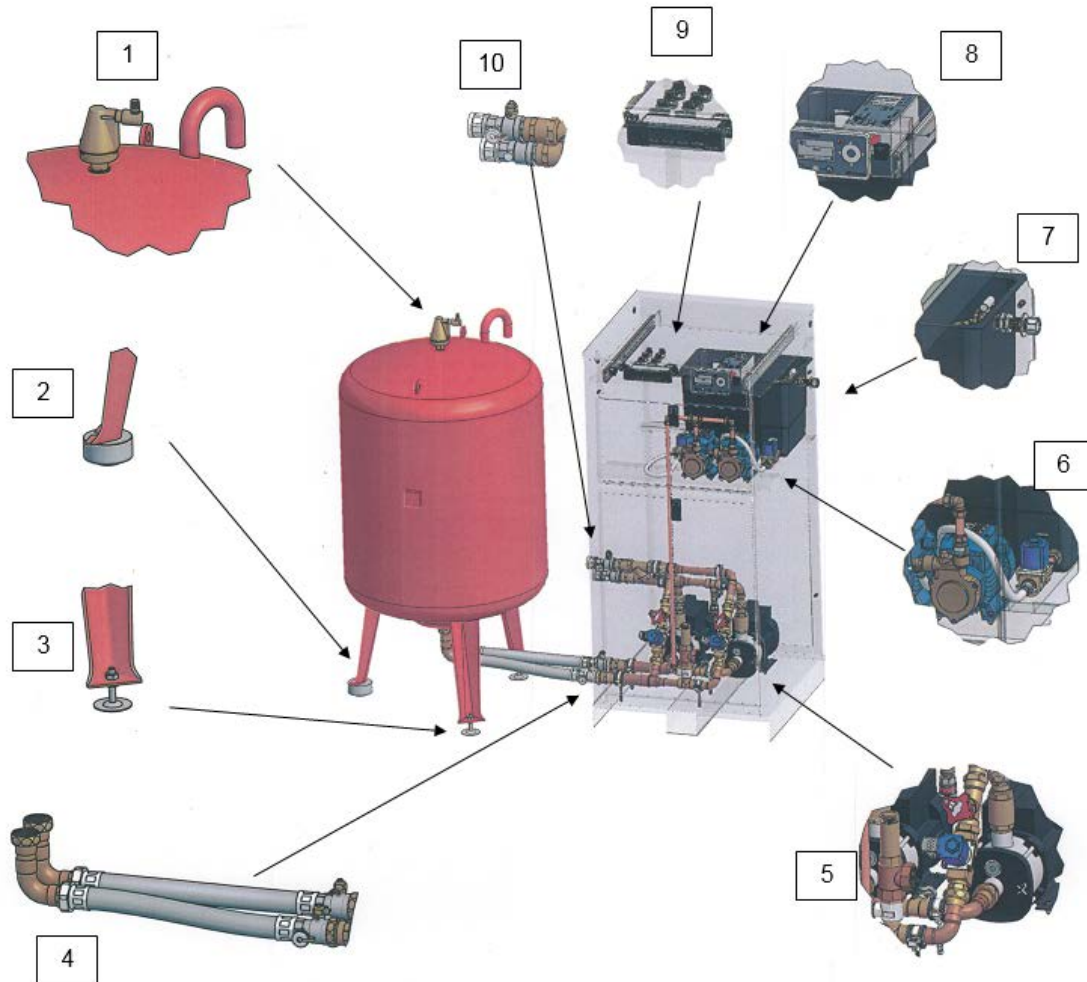

D0 Pumpset shown for illustration

1. Automatic air vent assembly
2. Weight sensor
3. Jack screw for vessel x 3 (>1200 l)
4. Flexible hose kit
5. Transfer pump set arrangement
6. Top up pump set arrangement
7. Break tank assembly
8. SPC Controller / Terminal box
9. Micro controller (Top up controller)
10. System connection (Locksheild valve)

Spare parts list

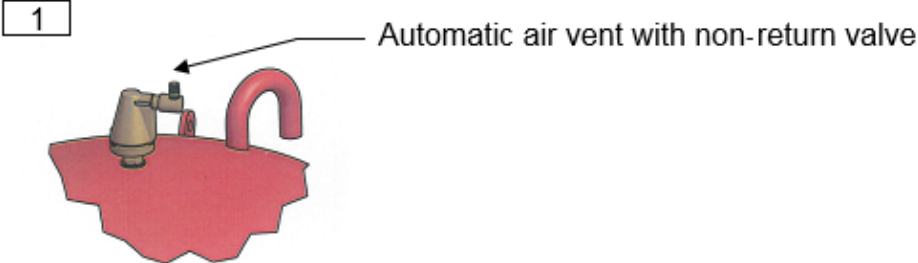

Description	Part code
Flexvent super ½" with air intake peventor	STA01570

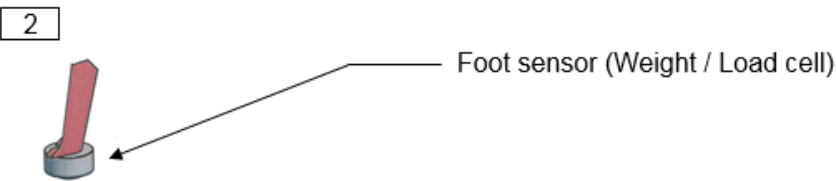

Description	Part code
Level sensor FSI 1 (150 - 300l) <2017	STA07415
Level sensor FSI 2 (400 - 800l) <2017	STA07416
Level Sensor FSI 3 (1000l - 2000l) <2017 (up to 1000L)	STA07417
Level sensor FSI 4 (2800 - 3500l)	STA07418
Level sensor FSI 5 (5000 - 10000l)	STA07419

FS1 / FS2 / FS3 version above are up to 2017 after 2017 please see number 3 for details

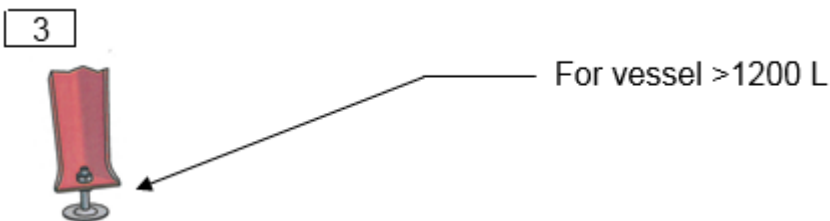

These are standard issue with vessel >1200L

Flamcomat vessel – 2017 Onwards (Up to 1000 L)



Flamco

Flow of Innovation

Vessel size (L)	Bladder	Extension piece >P<	Level sensor >Q<	Adjusting foot >R<
200	STA10017	STA10039	STA10036	STA10033
300	STA10018		STA10037	
400	STA10019	STA10030		STA10038
500	STA10020			
600				
800	STA10021			
1000	STA10022			

Every number corresponds with 1 item only.

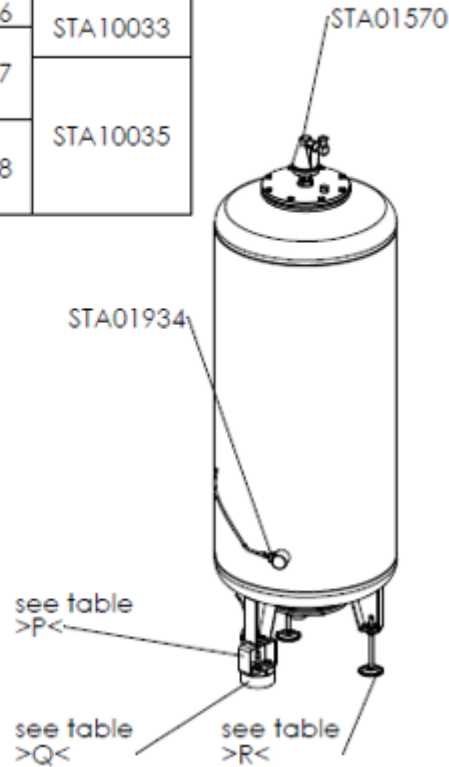

Description	Part code
Level sensor FSI B1 (200l) >2017	STA10036
Level sensor FSI B2 (300l - 500l) >2017	STA10037
Level Sensor FSI B3 (600l - 1000l) >2017	STA10038
Weight sensor connector - Flamcomat	STA10043
Diaphragm Rupture Sensor 200l - 1000l FMAT >2017	STA01934
Flexvent super ½" with air intake preventor	STA01570
Diaphragm 200l >2017	STA10017
Diaphragm 300l >2017	STA10018
Diaphragm 400l >2017	STA10019
Diaphragm 500l - 600l >2017	STA10020
Diaphragm 800l >2017	STA10021
Diaphragm 1000l >2017	STA10022
Extension piece for level sensor M12 [200l - 300l]	STA10039
Extension piece for level sensor M16 [400l - 1000l]	STA10030
Adjusting foot M12 [200l - 300l]	STA10033
Adjusting foot M16 [400l - 1000l]	STA10035



4

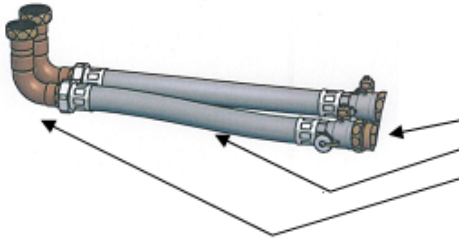

Flexible connection set. For main vessel(s) only.
 Lockshield valve complete with drain point,
 Flexible hose
 Elbow and swivel nut.

Description	Part code
Vessel connection Type 4	17730
Vessel connection Type 5	17731

5

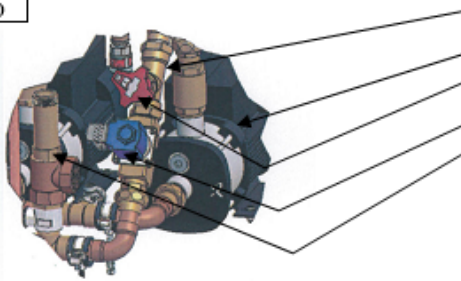

Non- return valve (Transfer pump)
 Transfer pump
 Flow restrictor valve
 Expansion solenoid valve
 Safety relief valve (vessel protection only)

Kit No	Kit Description	Part Description	Qty
STA12529	Flamcomat System Solenoid D0-D3	1BSP Solenoid EV250B 032U5256	2
		Solenoid Coil	2
		Solenoid Plug	2
STA12530	Flamcomat System Solenoid D4-D6	Solenoid 1/2bsp 16bar EV220B (032U7115)	2
		Solenoid Coil	2
		Solenoid Plug	2

Description	Part code
Non-return valve	
Non- Return Valve (Check Valve) 1" (D0, D1, D2)	STA01922
Non- Return Valve (Check Valve) 1/2" (D4, D5, D6)	STA06636
Flat Non- Return Valve D3 to D6	STA02037
Safety relief valve	
1-1/4" 2 bar Safety relief valve D3 - D6	STA09675
1" 2 bar Safety relief valve D0 - D2	STA06288

Description	Part code
Transfer pump	
Pump D0 CM 1-4 A-R-I-E AQQE CAAN (1 x 230V)	STA06824
Pump D1 CM3-6 A-R-I-E AQQE CAAN (1 x 230V)	STA06825
Pump D2 CM5-6 A-R-I-E AQQE (3 x 415V)	STA06827
Pump D3 CR3-15 A-FGJ A-E HQQE (1 x 230V)	STA06828
Pump D4 CR3-17 A-FGJ-A-E HQQE (3 x 415V)	STA06704
Pump D5 CR3-23 A-FGJ-A-E HQQE (3 x 415V)	STA06829
Pump D6 CR3-31 A-FGJ-A-E HQQE (3 x 415V)	STA06830

6

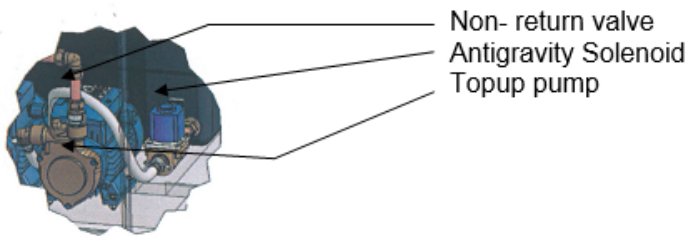

Kit No	Kit Description	Part Description	Qty
STA12505	Pump Flamco PQAm60	PQA60 PUMP	1
		RING CRIMP	1
		0.75MM CABLE BLACK	1.03
		1/2 NON RETURN VALVE	1
		15mm x 1/2BSP C X Mi Coupling	2
		15mm x 1/2BSP C X Mi Elbow	1

Kit No	Kit Description	Part Description	Qty
STA12531	Topup Solenoid Kit	1/2BSP Solenoid EV250B	1
		Solenoid Coil	1
		Solenoid Plug	1

7

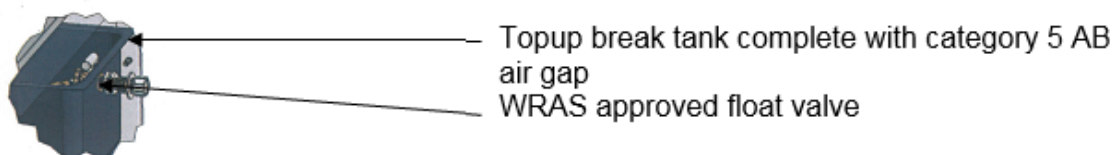

Kit No	Kit Description	Part Description	Qty
STA12514	Mains Inlet Kit 18L tanks	WATER INLET BALLVALVE/FLOAT	1
		LOW LEVEL FLOAT SWITCH	1

8



SPC controller main terminal box
SPC controller panel

Description	Part code
SPC Controller	
SPC Controller 230v D0, D1, D2, D3, D4, D5, D6	STA06018
Terminal box	
Motor Contactors for D2 (3 Phase) (2 x 1.3 kW)	STA06851
Motor Contactors for D4 (3 Phase) (2 x 1.5 kW)	STA06819
Motor Contactors for D5 (3 Phase) (2 x 2.2 kW)	STA06821
Motor Contactors for D6 (3 Phase) (2 x 3.0 kW)	STA06823

9



Topup controller

Kit No	Kit Description	Part Description	Qty
STA12500	Controller Spares Kit	Micro Controller	1
		On/Off Switch	1
		Electrical Plate - Two pump	1

10



System connection lockshield valve

Description	Part code
Ball Connection Valve & Adaptor DN32	17738

Not shown items

Description	Part code
Pressure Sensor	
Topup Pressure Sensor 10b (1-6V) 060G3996	STA12543
Topup Pressure Sensor 16b (1-6V)	STA12544
JUMO MIDAS 0-20 mA 0-16 Bar (Transfer pump sensor)	STA06286
Strainer (outlet)	
Particle Filter D0, D1, D2, D3	STA01559
Particle Filter D4, D5, D6	STA01560
Balancing Valve	
BALANCING VALVE - IMI STAD DN15 (D0 - D3)	STA07510
BALANCING VALVE - IMI STAD DN25 (D4 - D6)	STA09332



Transducer 0-10 Bar (1-6V)



Transducer 0-16 Bar (1-6V)



Particle Filter



Jumo Midas 0-20mA
(Transfer pump transducer)



Balancing Valve DN15

Accessories

Auxiliary vessel connection

Connection set including T-piece PN10, hose and a block & bleed valve for easy installation of a Flamcomat FB auxiliary vessel.

Description	Part code
Auxiliary vessel connection Flamcomat	17647



T-Piece

T-piece PN 10 for an easy installation of a Flamcomat FB auxiliary vessel.

Description	Part code
T-Piece G 1-½"	17664



Pressure Safety Switch

Description	Part code
Minimum pressure switch	27459
Maximum pressure switch	27458



Bimetallic Temperature Switch

Electromechanical switch with fixed switching temperature of 70 °C.

Flamcomat: Reaching 70 °C is detected as an error and is stored in the error memory. When this temperature is reached the temperature, switch prevents the system from degassing until the temperature falls below 70 °C again.

Description	Part code
Bimetallic Temperature Switch	17659



Diaphragm Rupture sensor

To be fitted to Flamcomat main vessel to monitor vessel's diaphragm. Can be integrated later date. Used on > 1200L



Description	Part code
Diaphragm rupture sensor	22386

Analogue Signalling

For analogue signalling (0-10 V) of vessel volume (0-100%) and system pressure (0-16 bar).

- Build-in afterwards is possible.



Description	Part code
Analogue Signalling	17802

SD Card Module

External SD Card module used for:

- Saving of SPC parameter files.
- Downloading of files via SD Card to PC.
- Transmission of the files to Service Centre.
- Firmware updates by the service support.



Description	Part code
SD Card Module	17803

SPC Extension Module

Connection module for communication between two controls.

- For SPC control.
- Makes linked operating options possible (Configuration and Commissioning by Flamco Service Only).



Description	Part code
SPC Extension Module Master + Slave	17500
Extra Slave Module	17501



Flamco

Flow of Innovation

Flamco Limited

Washway Lane
St. Helens
Merseyside WA10 6PB
United Kingdom

T +44 1744 744 744

F +44 1744 744 700

E info@flamco.co.uk