

For more detailed PDF instructions scan the QR code.

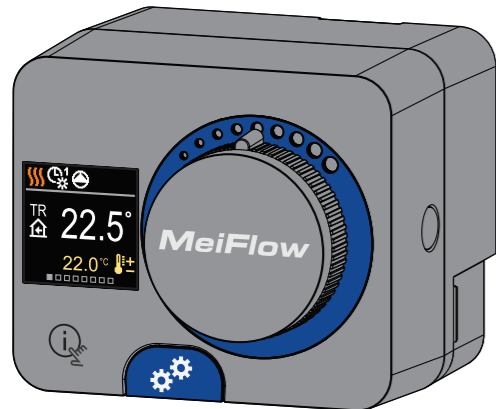

Compact weather compensated controller

MWR3



The MWR3 is a compact, weather-compensated heating controller built into the actuator housing. The controller can also be used in systems without an outdoor sensor, but then the use of a room unit is mandatory.

Warnings

Check the controller and its packaging carefully. If you see visible damage to the controller, do not use it. Installing a damaged product can be life-threatening. When adjusting the controller, pay attention to the correct opening direction of the valve. Wrong turning direction can lead to high or low temperatures in the system and consequently damage to the system.

When adjusting the controller, make sure you set the minimum and maximum value of requested temperatures correctly. Incorrectly selected limit values for setting the requested temperature lead to a wrong setup of requested temperature and, consequently, undesirable operation and/or damage to the system and user.

The fixed value controller is designed to control a mixer. Any other use is not intended. The controller may only be installed and operated in:
 -Dry, non-explosive environment.
 -Enclosed rooms.
 -Rooms with a temperature between 0 °C and +55 °C.

Every project with controller must have independent system protection for cases of too low or too high temperatures. The controller does not perform protection functions for cases of too high or too low temperatures in the system. High or low temperatures in the system can cause damage to the system and user.

Appearance of the controller

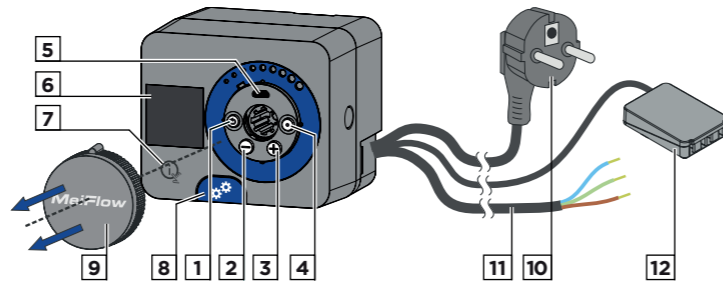

1. Button . Return back.
2. Button . Move to the left, decreasing.
3. Button . Move to the right, increasing.
4. Button . Menu entry, confirmation of selection.
5. USB port for software updates and connection to a personal computer.
6. Graphic display.
7. Button . Help.
8. Manual operation clutch.
9. Manual movement button.
10. Pre-wired power cord with plug.
11. Pre-wired cable for circulation pump.
12. Pre-wired connection box for sensors and communication.

Controller installation

In a warm interior, the controller can be mounted directly on the mixing valve with the help of the accessories provided. Avoid close proximity to any strong electromagnetic fields.

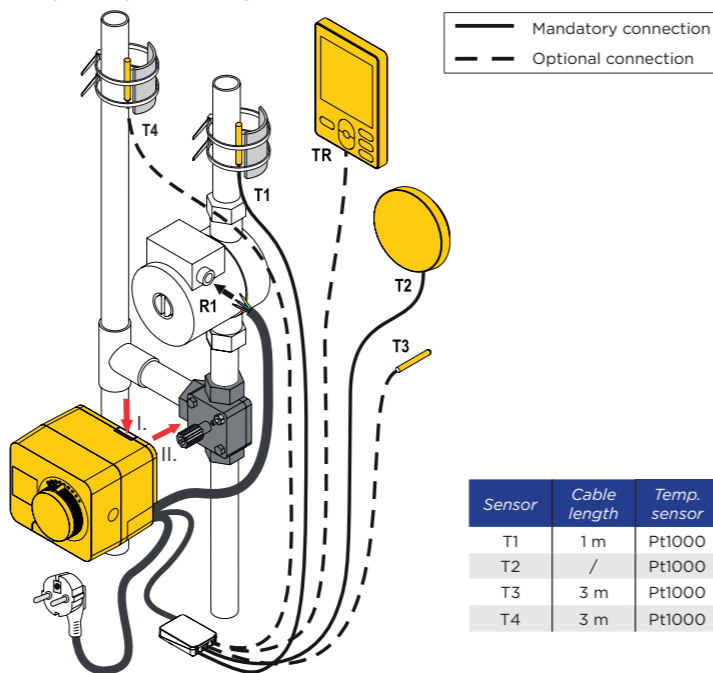

Scheme	Mixing valve position	Ring position
360		
360b		
361		
361		

Hydraulic schemes

SCHEMA 360 - Heating circuit

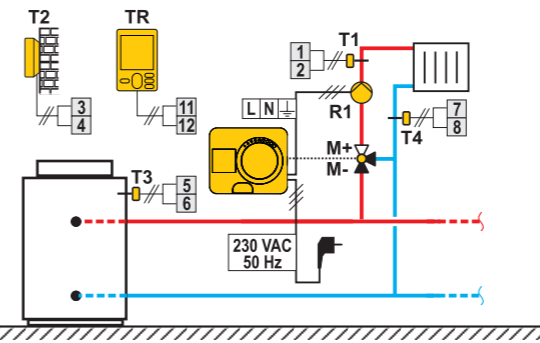

SCHEMA 360b - Additional heating circuit

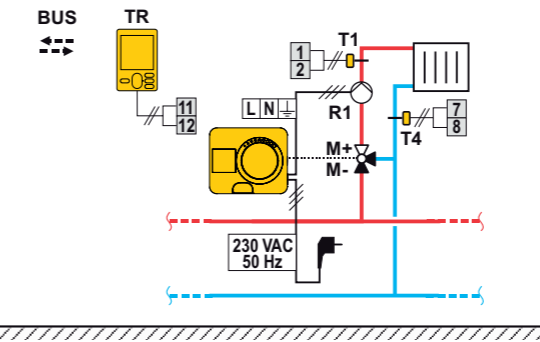

Connection of temperature sensors

The controller allows the connection of four Pt1000 temperature sensors (connection terminals 1 to 8). The sensor function depends on the hydraulic diagram and setup of parameters S1.6 and S1.7. One room unit can be connected to one controller.

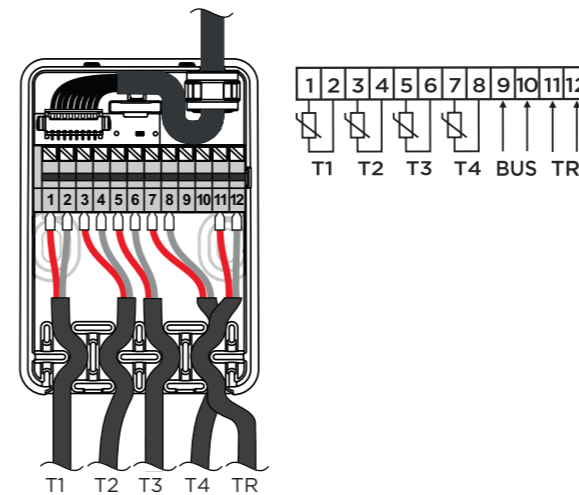

BUS connection of controllers

With the BUS connection, any number of MWR3, W.. and K.. controllers can be connected to each other. The first or leading controller physically controls the energy sources, while the other controllers only control the heating circuits.

The outdoor temperature sensor and the sensor of the heat source temperature must be connected to the first controller.

Example of BUS connection of MWR3 controllers:

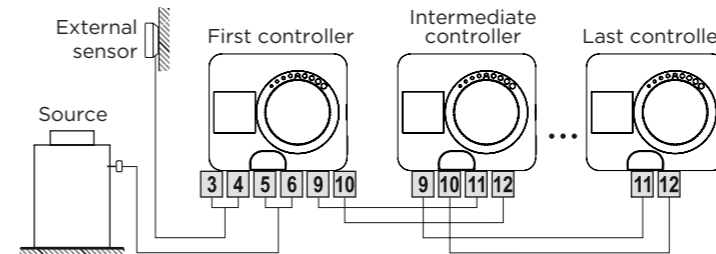

Example of BUS connection of W.. and MWR3 controllers:

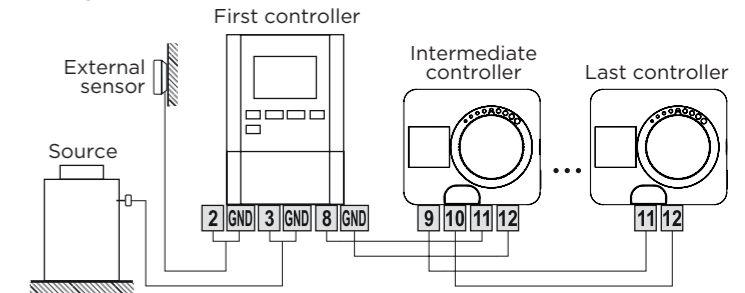

Initial controller setup

The controller is equipped with an innovative "Easy start" function, which allows the initial setting of the controller in just four steps. Upon the first connection of the controller to the power supply network, the first step of the controller setup is displayed after the program version and logo. The manual movement button must be removed for the setup. The Easy start function is activated by pressing the buttons and and holding them both down together for 5 seconds.



Step 1 - language setup



Use the buttons and to select the requested language. Confirm the selected language by pressing . If you've mistakenly selected the wrong language, you can return to the language selection with the button.

Later, you can change the language in the „Display“ menu.

Step 2 - hydraulic scheme setup



You can select the hydraulic scheme for the controller operation. Use the buttons and to navigate between schemes. Confirm the selected scheme with the button. If you have mistakenly selected the wrong scheme, you can return to the diagram selection with the button.

Later, you can change the selected hydraulic scheme with the service parameter S1.1.

Step 3 - setup of heating curve steepness

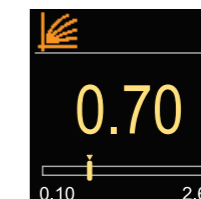

You can set the heating curve steepness. The steepness can be set with the buttons and . Confirm the set steepness with the button . If you have accidentally set the wrong steepness, return to re-selecting the steepness with the button .

Later, you can change the steepness of the heating curve with the user parameter P2.1.

Step 4 - selecting the opening direction of the mixing valve



You can select the opening direction of the mixing valve. Use the buttons and to navigate between directions. Confirm the selected direction with the button. If you have mistakenly selected the wrong direction, you can return to the direction selection with the button.

Later, you can change the opening direction of the mixing valve with the service parameter S1.3.



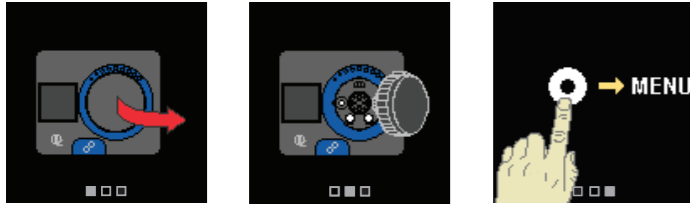

Help

By pressing the  button we can start the display animation, which leads us to the additional settings menu.

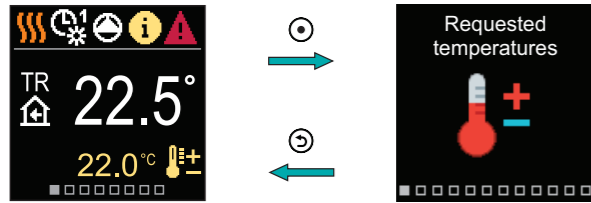

Entering and navigating through the menu





Press the  button to enter the menu. Navigate through the menu with the  and  buttons and use the  button to confirm your selection. Press the  button to return to the previous screen.

Requested temperatures

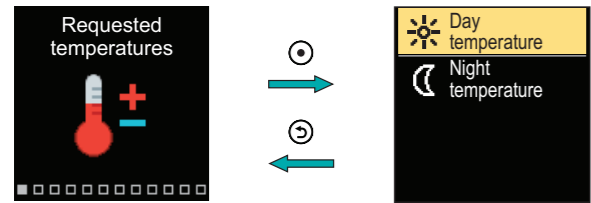
In the menu, you can change the setting of the requested temperatures.





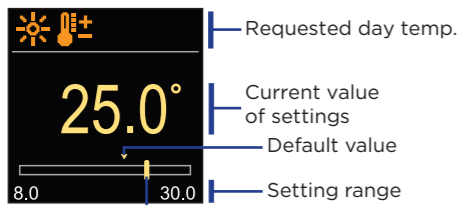

Navigate through the menu with the  and  buttons and use the  button to confirm your selection. A new screen with temperatures will open.

Requested day temperature







Current value of the requested temperature

Use the  and  buttons to select the requested temperature and confirm it with the  button. Exit the setting with the  button.

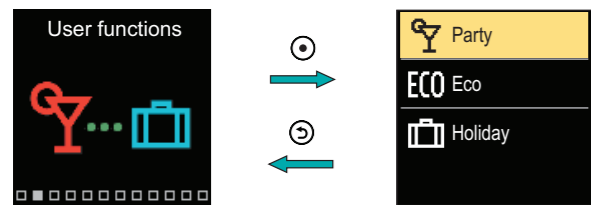
User functions

User functions enable additional comfort and benefits of using the controller.





Navigate through the menu with the  and  buttons and use the  button to confirm your selection. The screen for turning on and setting the user function opens.

Party user function

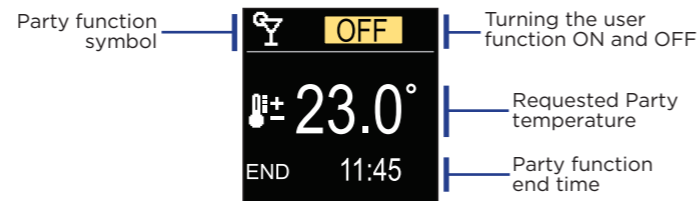
The PARTY function activates the operation according to the requested comfort temperature until the set end time.





With the buttons  and  you can change the setting value and with the button  you can move on to the next setting.

Operation mode

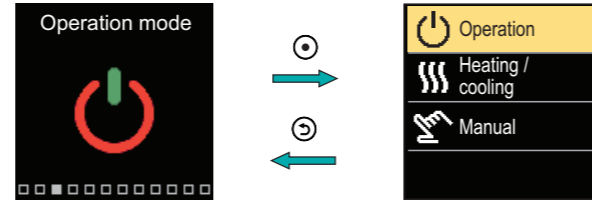

In the menu, you can select the requested operation mode and other operation options.





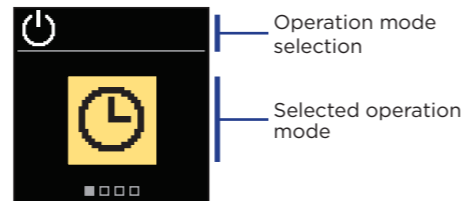

Navigate through the menu with the  and  buttons and use the  button to confirm your selection.

Operation selection







Use the buttons  and  to select the requested operation. Exit the setting by pressing  or .

Symbol	Description
	Operation according to the selected time program with day and night temperature which is set on the controller.
	Requested day temperature operation mode.
	Requested night temperature operation mode.
	Switch-off. Frost protection remains active, if operation mode heating is selected. The overheating protection remains active, if operation mode cooling is selected.

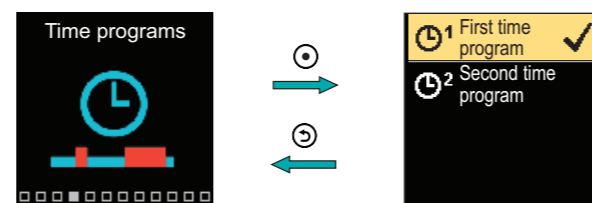



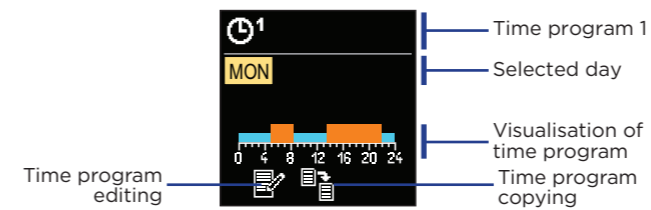

Time programs

Weekly time programs enable automatic switchover between day and night temperature. There are two time programs available. A check mark next to the time program tells which time program is selected for operation.



Navigate through the menu with the  and  buttons. With the button  you can select the time program for operation and with the button  you can enter the setting of the selected time program.







With the buttons  and  you can select the day for which you want to edit or copy the time program and confirm it with the button . Now, with the buttons  and  select the icon to edit or copy the time program and confirm it with the button .

Default settings of time programs:

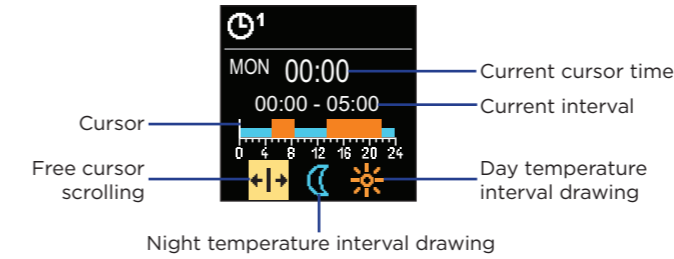
Time program	Days	Time interval
⌚ ¹	Mon - Fri	05:00 - 07:30 and 13:30 - 22:00
	Sat - Sun	07:00 - 22:00
⌚ ²	Mon - Fri	06:00 - 22:00
	Sat - Sun	07:00 - 23:00





Time program editing

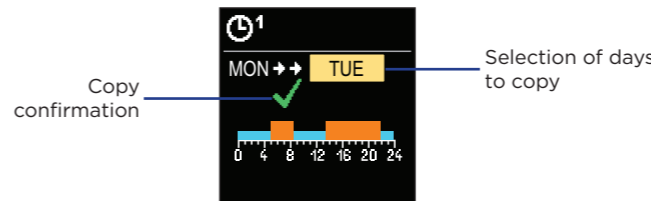

With the button  select the requested icon to scroll or draw the interval, using the buttons  and  you can draw the requested course of the time interval. Exit the time program editing by pressing the button .

Time program copying



With the buttons  and  you can select the day for which you want to edit or copy the time program of the displayed day. Confirm the time program copying by pressing the button . Exit the time program copying by pressing the button .

Clutch and manual valve displacement

Pressing the clutch I. activates the manual valve displacement. You can now move the mixing valve by turning the button II. To return to automatic operation, press the clutch I. again. When the clutch is activated, the clutch symbol appears on the display.

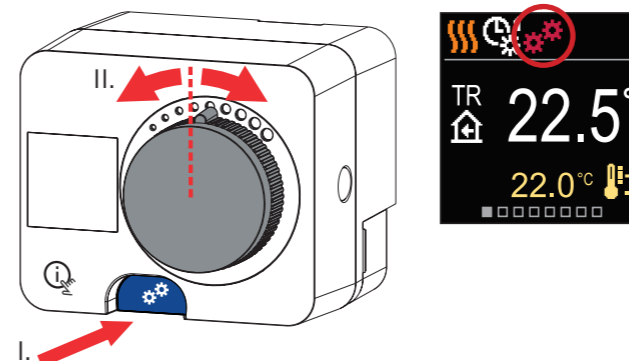

Replacement of the power cord

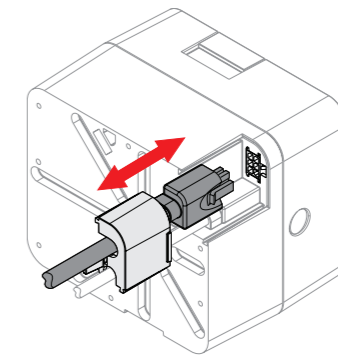

If the power cord is damaged, it can be replaced. The cable is equipped with the mains plug and connector. To replace the cable, the cable protection cover must first be removed.

 The replacement of the power cord is only possible with the original power cord.

 **Fatal risk of electric shock!** Before starting the installation, always make sure that you are completely disconnected from the mains and secure against being switched on again!

Dimensions

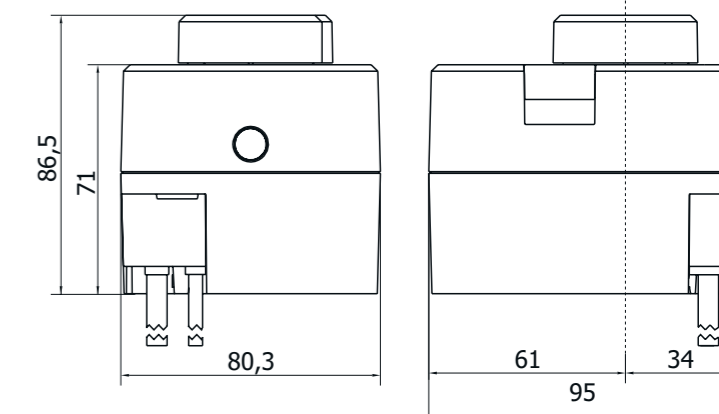

Technical data

Technical data	Value
Torque:	6 Nm
Rotation angle:	90 °
Rotation speed:	2 min / 90 °
Type of operation:	3-point, PID
Supply voltage:	230V AC, 50 Hz
Energy consumption in operation:	3.5 W
Energy consumption in standby:	max. 0,5 W
Temperature range:	0 ÷ 50 °C
Output pump:	1(1)A, 230V-
Nr. of sensors:	4
Protection class:	IP42 according to EN 60529
Safety class:	I according to EN 60730-1
Dimensions (W x L x H):	86.5 x 95 x 80.3 mm
Weight:	800 - 1000 g
Colour / material:	Dark gray / PC
Battery:	CR1025 (Li-Mn) 3V
Clock accuracy:	+/- 1s (24h) at 20 °C

MEIBES System-Technik GmbH
Ringstrasse 18
D-04827 Gerichshain



01 MC060660