

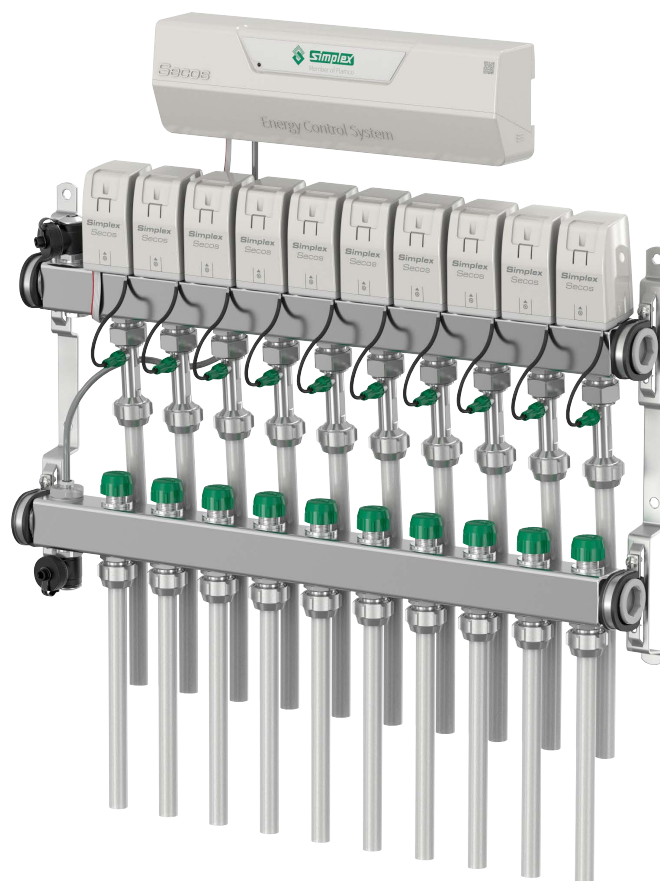

# Secos - Simplex Energy Control System



Careful with energy.  
Generous with emotion.



# Secos - Simplex Energy Control System



## Table of contents

1.	Product description .....	3
2.	Introduction .....	4
3.	Safety instructions .....	5
4.	Scope of supply .....	6
5.	Technical data .....	7
6.	Installation of Secos system manifold and Secos energy saving controller unit .....	10
7.	Installing the Secos energy saving controller .....	16
8.	Electrical connection .....	17
9.	Commissioning .....	26
10.	Operation .....	28
11.	Maintenance / service .....	33
12.	Troubleshooting / fault elimination .....	34
13.	FAQ .....	36
14.	Spare parts and accessories .....	37
15.	Disposal .....	38
16.	Contact persons and contacts .....	38
17.	Declaration of Conformity CE conformity .....	39

# Secos - Simplex Energy Control System

## 1. Product description

Secos is a highly innovative control system for surface temperature control where both volume flow and temperature are constantly measured and optimally controlled. This ensures permanent hydraulic balancing at all times.

### 1 Secos system manifolds

- Supply and return manifolds made of stainless steel 1" female thread.
- One filling / emptying / flushing / venting device per manifold.
- Pre-assembled snap-on board to accommodate the Secos actuator.
- Secos multi-sensors mounted and wired at the factory.
- Delivered ready for installation on manifold bracket with sound insulation.
- Outlets in ¾" Eurocone.
- Including Simplex filling and drainage plugs.

### 2 Secos energy saving controller

- Central core of the Secos Energy Control System.
- Evaluation of the system data and automatic control according to requirements.
- To control the flow rate as well as the heat output in each circuit.
- Suitable for heating and cooling.
- Bus communication between energy-saving controller and actuators.
- For up to 8 separate room thermostats
- Assignment of the room thermostats to Secos actuators possible.
- With building management system connection (Modbus).
- Wireless connection via app Flamconnect.
- External condensation monitor can be connected.
- Valve and pump protection function.
- For all other features see "Functions & Features":

### 3 Secos actuator for ceramic valves

- Low power consumption - consumption only during movement.
- Continuous adjustment with precise position control.
- Prewired plug connection.
- Only 1 plug for all Secos actuators.
- Snap-on: Snap-on technology for mechanical and electrical connection with just one click for error-free and time-saving installation.

### 4 Secos mounting bracket

- Manifold bracket including sound insulation.
- Mounting in distribution cabinet or wall mounting.
- Sturdy version made of galvanized steel.

### 1 Product description

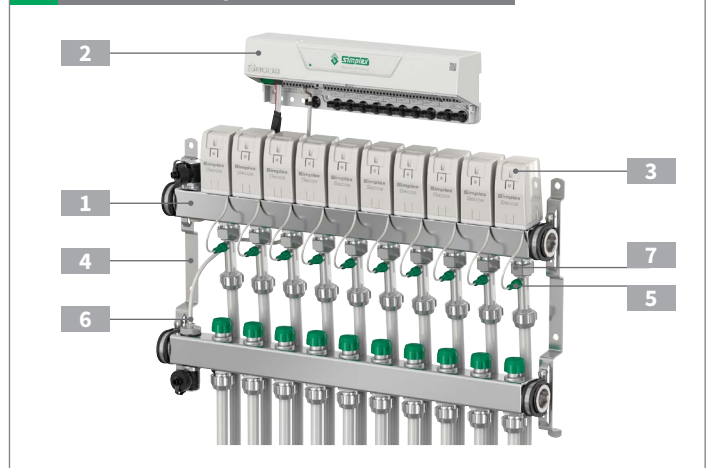

### 5 Secos multisensor

- For recording the volume flow and return temperature in each heating circuit.
- No moving elements.
- Minimal pressure loss.
- Zero-flow detection.
- Prewired at the factory.

### 6 Secos supply line temperature sensor

- Recording of the supply line temperature in the system.
- Additional safety device for monitoring the maximum permissible supply line temperature.

### 7 Secos disc valves

Unlike conventional standard systems with lift valves, Secos works with ceramic disc valves which are actuated by a rotary movement. The specially designed ceramic discs allow linear valve opening, which ensures a uniform valve characteristic curve. In conjunction with the Secos actuators and the infinitely variable valve positions, this enables very precise control of the volume flows in all heating circuits.

- Disc valve with trend-setting ceramic technology.
- For heating / cooling applications.
- Wear-resistant.
- Long service life.
- Stepless and precise supply line control in combination with Secos actuators.



# Secos - Simplex Energy Control System

## 2. Introduction

**These instructions describe the installation, operation and maintenance of the Secos control system for surface temperature control.**

Please read these instructions carefully before starting the installation work.

In the event of non-observance, all guarantee and warranty claims are void.

The instructions are intended for trained specialist tradesmen who have the appropriate knowledge in handling heating systems, water pipe installations and electrical installations.

Installation and commissioning may only be carried out by trained specialist personnel.

The illustrations are symbolic and may deviate from the actual product.

Subject to technical modifications and errors.

### 2.1. Intended purpose and proper use

The Secos Energy Control System is used to distribute heating water in water heating and cooling systems. The system simultaneously records and controls the volume flows and temperatures of individual circuits.

The Secos Energy Control System is ideal for both new buildings and refurbishments.

The control system may only be operated with the media, operating and ambient conditions specified in the technical data.

The Secos Energy Control System may only be installed and operated in frost-protected, dry rooms.

The Secos Energy Control System should be protected against solar radiation, heat radiation and vibration.

Operation outside the permissible operating and ambient conditions can cause damage to the system.

Usage contrary to the regulations and changes in assembly, construction or components can endanger the safe operation of the system and lead to the exclusion of all warranty and guarantee claims.

### 2.2. Flamconnect app for operation



Commissioning the energy control system.

- ▶ The Flamconnect app must be installed on a terminal device (Android or IOS) before commissioning and operation.



# Secos - Simplex Energy Control System





## 3. Safety instructions

Work on the heating system must be performed by qualified specialist personnel in compliance with the respective applicable regulations, guidelines and technical rules.



In addition to country-specific guidelines and local regulations, the following technical rules must be observed:



- DIN EN 12828 Heating systems in buildings
- DIN 18 380 Central heating systems and hot water supply systems
- DIN EN 60335 Electrical apparatus for household and similar uses
- DIN EN 60730 Automatic electrical control equipment
- DIN EN 1264 Underfloor heating - systems and components
- VDI 2035 Scale formation in drinking water heating systems and water heating systems  
Avoidance of damage to water heating appliances.
- VDE 0100 Series of standards for the installation of electrical equipment
- BGV Regulations of the employers' liability insurance association (accident prevention regulations)

Warning symbol	Warning word	Meaning
	HAZARD	Hazards to persons. Non-observance will result in death or serious injury.
	WARNING	Hazards to persons. Non-observance may result in death or serious injury.
	CAUTION	Hazards to persons. Non-observance can lead to minor injuries.
	CAUTION	Information to prevent damage to property, to understand or to optimise work processes.

# Secos - Simplex Energy Control System

## 4. Scope of supply

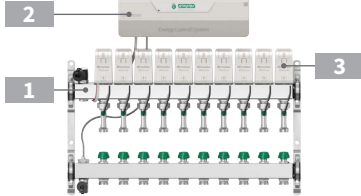
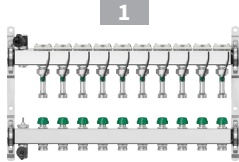
### 4.1. Overview of components per Secos system

Secos - Simplex Energy Control System		Secos system manifolds	Secos energy saving controller	Secos actuators
				
Art. no.	1 + 2 + 3	Art. no.	Art. no.	Art. no.
F18804	Secos System, 4 circuits	1 x F18820	1 x F18840	4 x F18841
F18805	Secos System, 5 circuits	1 x F18821	1 x F18840	5 x F18841
F18806	Secos System, 6 circuits	1 x F18822	1 x F18840	6 x F18841
F18807	Secos System, 7 circuits	1 x F18823	1 x F18840	7 x F18841
F18808	Secos System, 8 circuits	1 x F18824	1 x F18840	8 x F18841
F18809	Secos System, 9 circuits	1 x F18825	1 x F18840	9 x F18841
F18810	Secos System, 10 circuits	1 x F18826	1 x F18840	10 x F18841
F18811	Secos System, 11 circuits	1 x F18827	1 x F18840	11 x F18841
F18812	Secos System, 12 circuits	1 x F18828	1 x F18840	12 x F18841
F18813	Secos System, 13 circuits	1 x F18829	1 x F18840	13 x F18841
F18814	Secos system, 14 circuits	1 x F18830	1 x F18840	14 x F18841

### Completeness of the delivery

Please check the goods are intact and complete immediately after receipt of the delivery. Any damage or complaints must be reported immediately.

### 4.2. Flamconnect app for operation of the Secos energy-saving controller

The Secos energy-saving controller is operated using an app via a tablet or smartphone. You can use either iOS or Android devices.

You can download the required app from the respective stores.

As soon as the Flamconnect app is installed on your device, you can connect to the Secos Energy Saving Control System via the QR code on the housing and operate your Secos Energy Control System with ease.

For further information see the chapter on Operation and handling.

# Secos - Simplex Energy Control System

## 5. Technical data

### 5.1. General

Secos energy saving controller	
Number of connectable room thermostats	Up to 8
Number of operable heating circuits per control zone	1 - 14 heating circuits
Dimensions H x W x D	328 x 97 x 61 mm
Protection code	IP 20
Permissible ambient conditions	-10 - 60 °C, max. relative humidity 80 %, air pressure 750 - 1050 hPa
Supply voltage	230V AC / 50-60 Hz
Power consumption	max. 500 W
Output voltage for circulating pump	230V AC / 50-60 Hz
Interface for building management system	Modbus RTU
Frequency range for wireless connection	2402 - 2484 MHz
Maximum transmitting power	5 dBm

Secos system manifolds	
Number of heating circuits	4 - 14 heating circuits
Dimensions	(See Dimensions table)
Max. operating temperature:	75 °C
Max. operating pressure:	10 bar
Volume flow per heating circuit	0 - 8 l/min
Operating medium:	Heating water according to VDI 2035
Pressure loss system manifold complete	kvs 1.19 m <sup>3</sup> /h
Primary connections	G1" F
Secondary connections	G3/4" M Eurocone
Material of manifold bar	Stainless steel
Material of valves	ceramic disc valves
Secos supply line temperature sensor	Ø 6 x 50 mm
Closing stroke ceramic valve	90°

Secos actuator	
Dimensions H x W x D	47 x 77 x 57 mm
Operating temperature	-10 to 60 °C
Protection code	IP 20

Secos multisensor	
Measuring range for flow rate	0 - 8 l/min
Measuring range for temperature	+10 to +75 °C

Sensor characteristics														
Temperature	10 °C	15 °C	20 °C	25 °C	30 °C	35 °C	40 °C	45 °C	50 °C	55 °C	60 °C	65 °C	70 °C	75 °C
Multisensor [Ω]	52.0	52.9	53.9	54.9	55.8	56.8	57.8	58.7	59.7	60.7	61.6	62.6	63.5	64.5
Temperature sensor for supply line [Ω]	1039	1058	1078	1097	1117	1136	1155	1175	1194	1213	1232	1251	1271	1290



# Secos - Simplex Energy Control System

## 5.1.1. Secos system manifold dimensions

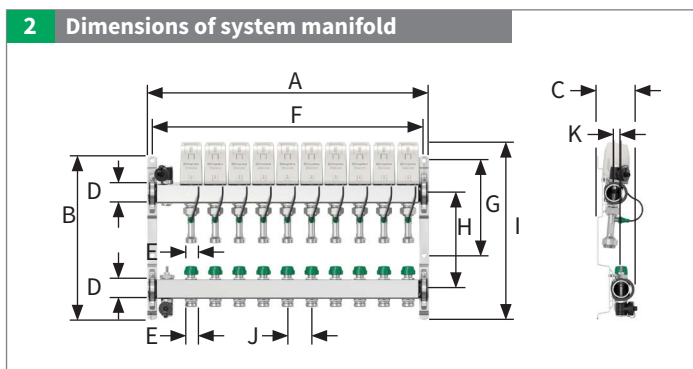

Type	A [mm]	B [mm]	C [mm]	D	E	F [mm]	G [mm]	H [mm]	I [mm]	J [mm]	K [mm]
VT FH Secos - 4 HC	304	340	78	G 1" F	G ¾" M (EC)	284	197	200	366	50	15
VT FH Secos - 5 HC	354	340	78	G 1" F	G ¾" M (EC)	334	197	200	366	50	15
VT FH Secos - 6 HC	404	340	78	G 1" F	G ¾" M (EC)	384	197	200	366	50	15
VT FH Secos - 7 HC	454	340	78	G 1" F	G ¾" M (EC)	434	197	200	366	50	15
VT FH Secos - 8 HC	504	340	78	G 1" F	G ¾" M (EC)	484	197	200	366	50	15
VT FH Secos - 9 HC	554	340	78	G 1" F	G ¾" M (EC)	534	197	200	366	50	15
VT FH Secos - 10 HC	604	340	78	G 1" F	G ¾" M (EC)	584	197	200	366	50	15
VT FH Secos - 11 HC	654	340	78	G 1" F	G ¾" M (EC)	634	197	200	366	50	15
VT FH Secos - 12 HC	704	340	78	G 1" F	G ¾" M (EC)	684	197	200	366	50	15
VT FH Secos - 13 HC	754	340	78	G 1" F	G ¾" M (EC)	734	197	200	366	50	15
VT FH Secos - 14 HC	804	340	78	G 1" F	G ¾" M (EC)	784	197	200	366	50	15



# Secos - Simplex Energy Control System

## 5.1.2. Dimensions of Secos energy saving controller and Secos actuator

- A** 328 mm
- B** 97 mm
- C** 61 mm

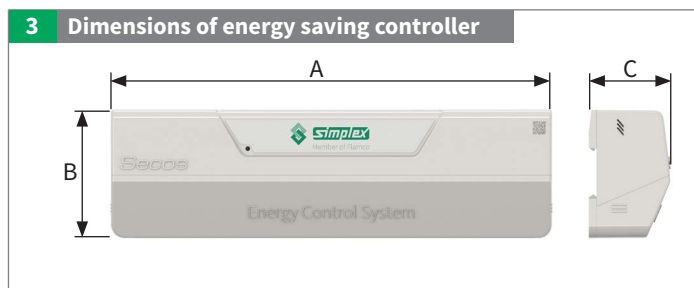

- A** 47 mm
- B** 77 mm
- C** 57 mm

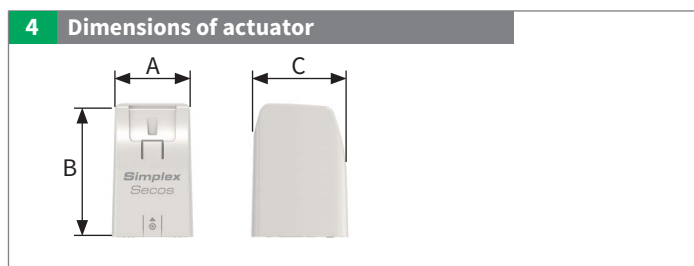

## 5.2. Pressure loss

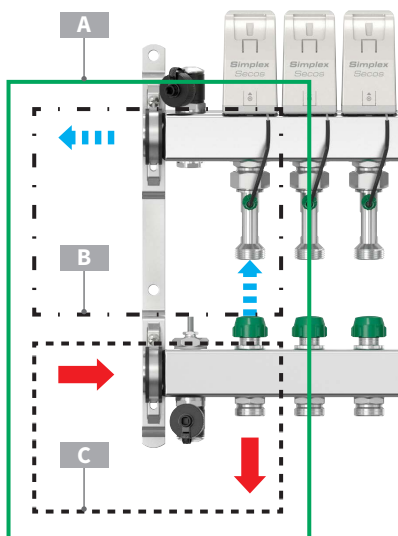

- A**  $\Delta p$  Secos total
- B**  $\Delta p$  Secos return line
- C**  $\Delta p$  Secos supply line

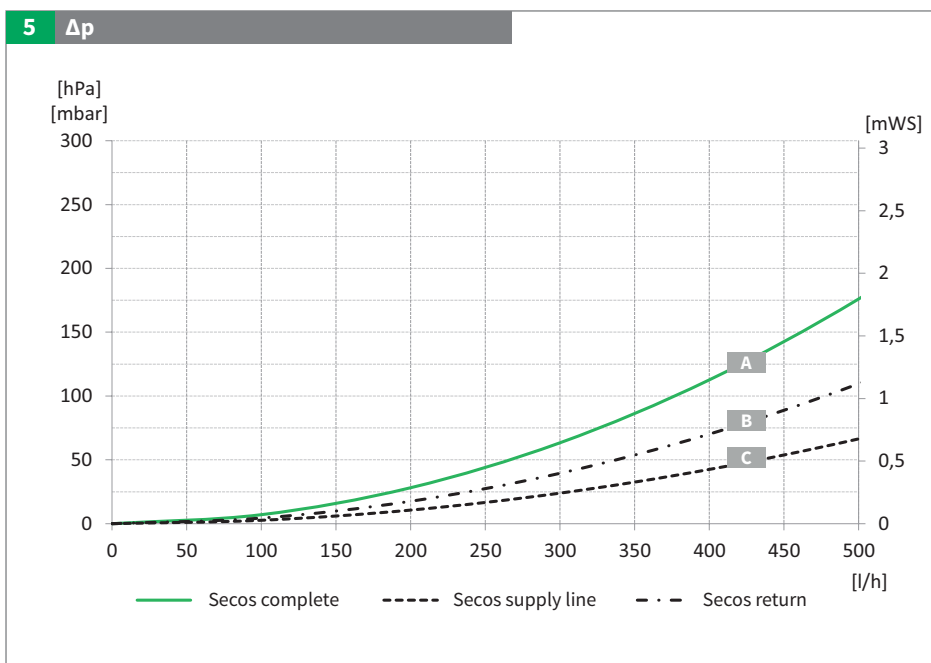



# Secos - Simplex Energy Control System

## 6. Installation of Secos system manifold and Secos energy saving controller unit

The hydraulics must be checked for leak-tightness before installation of the electronics. It must be ensured that no moisture can enter the electronics.

### 6.1. Installation of system manifold

The primary connections on the unit as delivered are located on the left-hand side.

- 1 Return line
- 2 Supply line
- 3 Temperature sensor supply line left

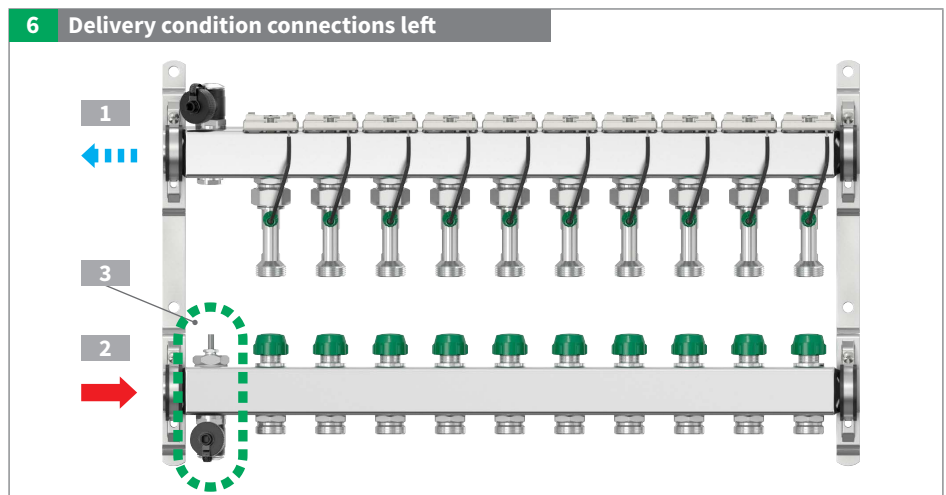

### Conversion from left to right

For this purpose on the upper manifold (return line)

- 1 Remove the dummy plug on the right-hand side
- 2 Screw in dummy plug on the left-hand side

The lower manifold (supply line)

- 3 Open the retaining bracket
- 4 Turn the manifold bar horizontally by 180°
- 5 Close the retaining bracket again

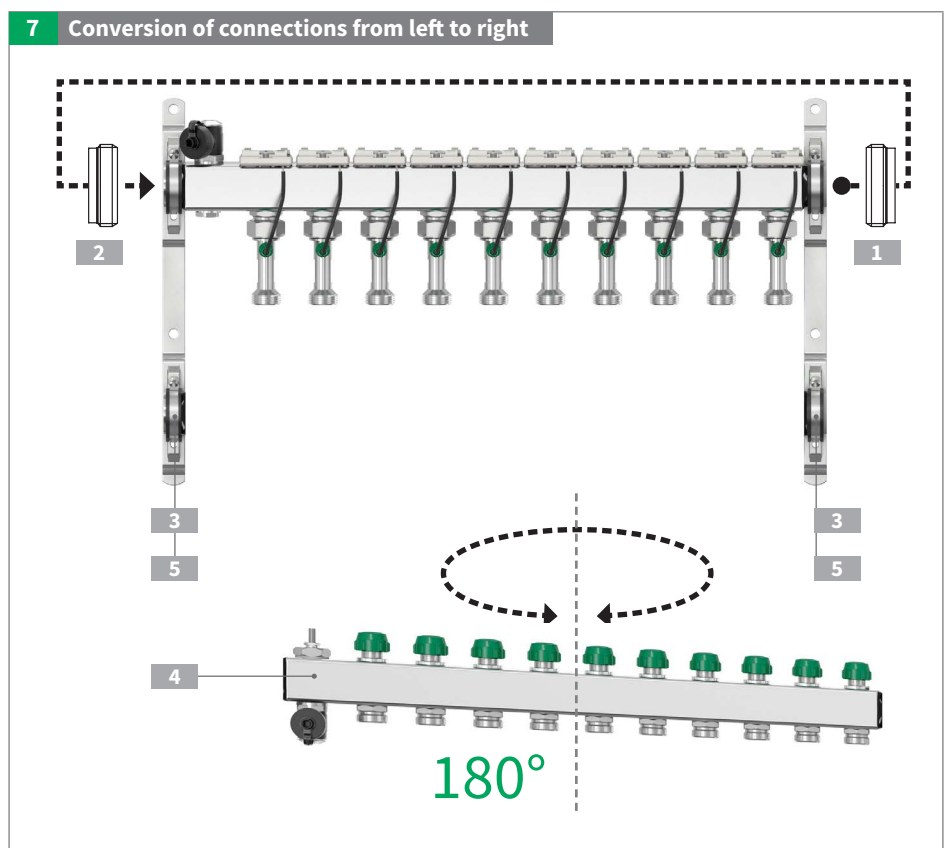

# Secos - Simplex Energy Control System

Secos system manifold after conversion with primary connections on the right-hand side

- 1 Return line
- 2 Supply line
- 3 Temperature sensor supply line

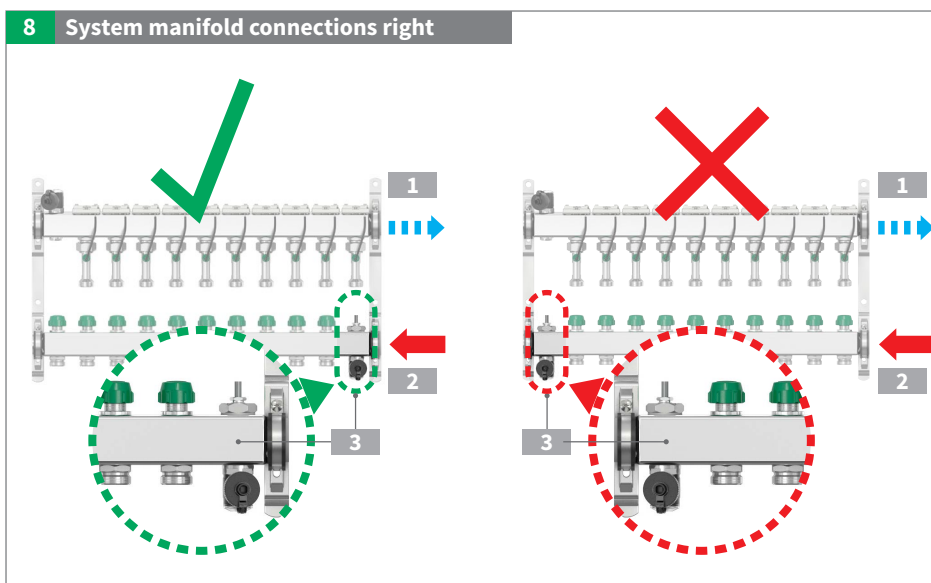

## 6.2. Installation in the distribution cabinet

Note the space required for accessories (energy saving controller, connection set (left, right) and pipe mounting (below).

Also take into account the space required for installation / maintenance work.

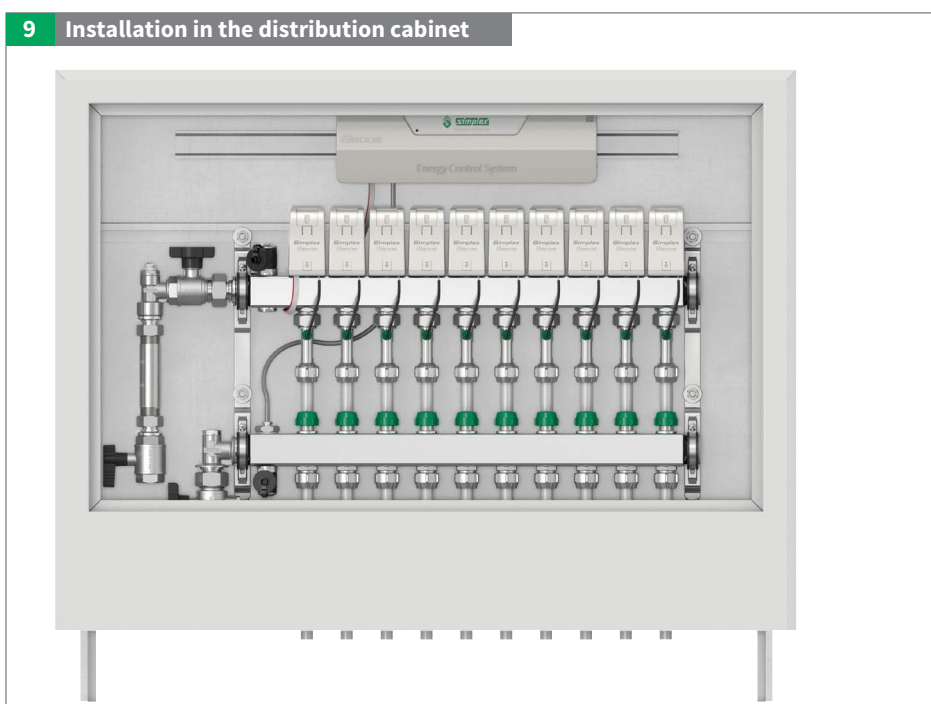



# Secos - Simplex Energy Control System

## 6.3. Installation on a wall

Observe space requirements for accessories energy saving controller incl. mounting location, connection set and pipe mounting.

See table for dimensions of fixing points (F, G).

See table for minimum clearance (L).

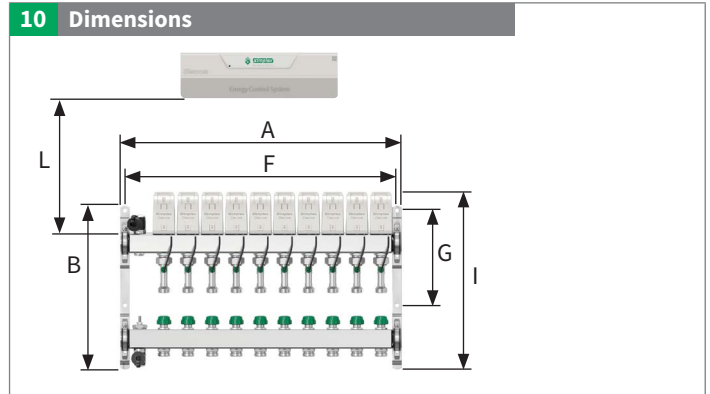

Type	A [mm]	B [mm]	F [mm]	G [mm]	I [mm]	L [mm]
VT FH Secos - 4 HC	304	340	284	197	366	115
VT FH Secos - 5 HC	354	340	334	197	366	115
VT FH Secos - 6 HC	404	340	384	197	366	115
VT FH Secos - 7 HC	454	340	434	197	366	115
VT FH Secos - 8 HC	504	340	484	197	366	115
VT FH Secos - 9 HC	554	340	534	197	366	115
VT FH Secos - 10 HC	604	340	584	197	366	115
VT FH Secos - 11 HC	654	340	634	197	366	115
VT FH Secos - 12 HC	704	340	684	197	366	115
VT FH Secos - 13 HC	754	340	734	197	366	115
VT FH Secos - 14 HC	804	340	784	197	366	115

# Secos - Simplex Energy Control System

## 6.3.1. Installation position

The Secos system manifold can be operated in various installation positions.

However, if the system manifold is to be operated outside the recommended installation position, the energy saving controller unit must not be placed in areas where water ingress is a risk.

The hydraulics must be checked for leak-tightness before installation of the electronics.

It must be ensured that no moisture can enter the electronics.

### 11 Recommended mounting position

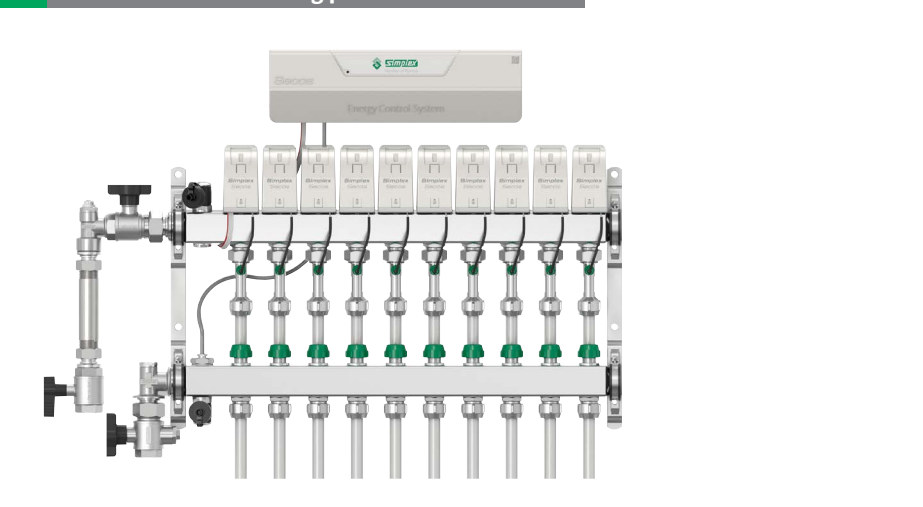

### 12 Other possible mounting positions

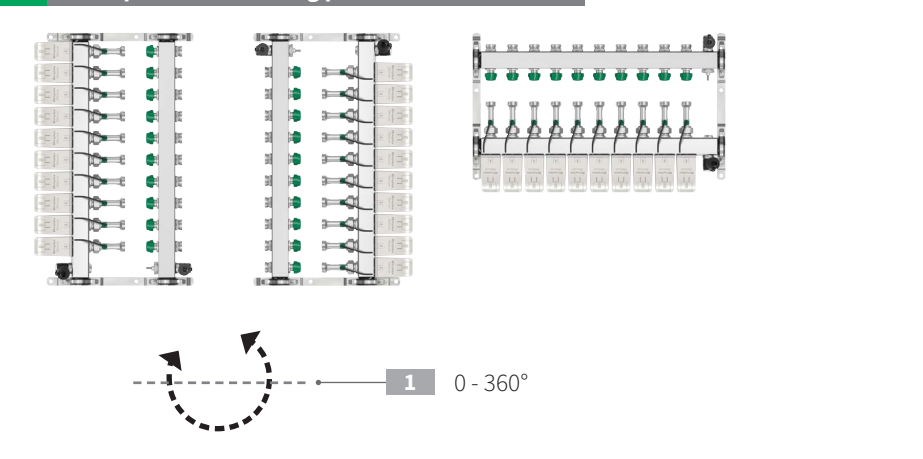

**1** The Secos system manifold can be mounted horizontally rotated from 0° to 360°.

Do not install the Secos energy-saving controller below water-bearing connections!

### 13 Installation options for energy saving controller





# Secos - Simplex Energy Control System

## 6.4. Hydraulic connection

### 6.4.1. Primary piping

Screw the connection accessories into the Secos system manifold according to the connection set being used.

Hold the unit to prevent twisting when screwing into the Secos system manifold.

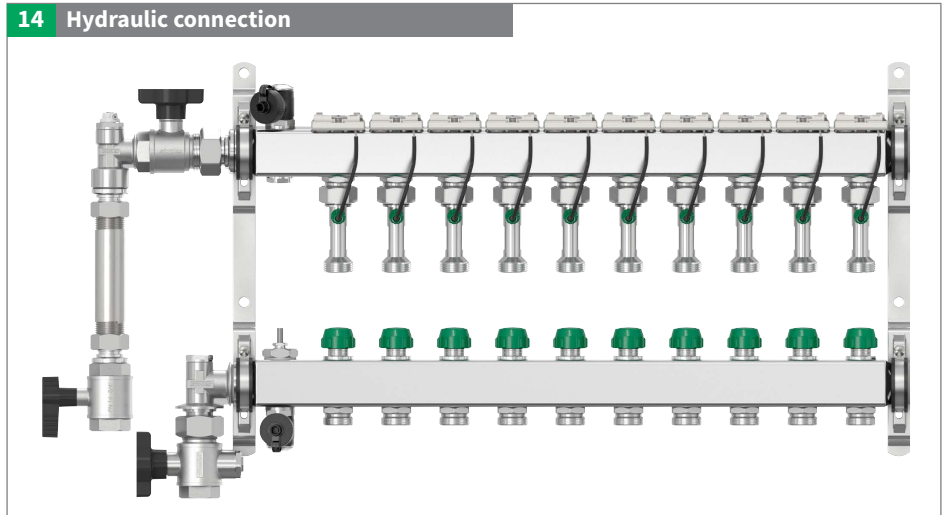

### 6.4.2. Secondary piping

For strain-free installation, hold the spanner flats of the multi-sensor against the spanner flats of the multi-sensor when tightening.

All circuits are open on delivery to allow you to carry out a leak test.

- Close unused connections securely with cap. (not included in scope of supply)

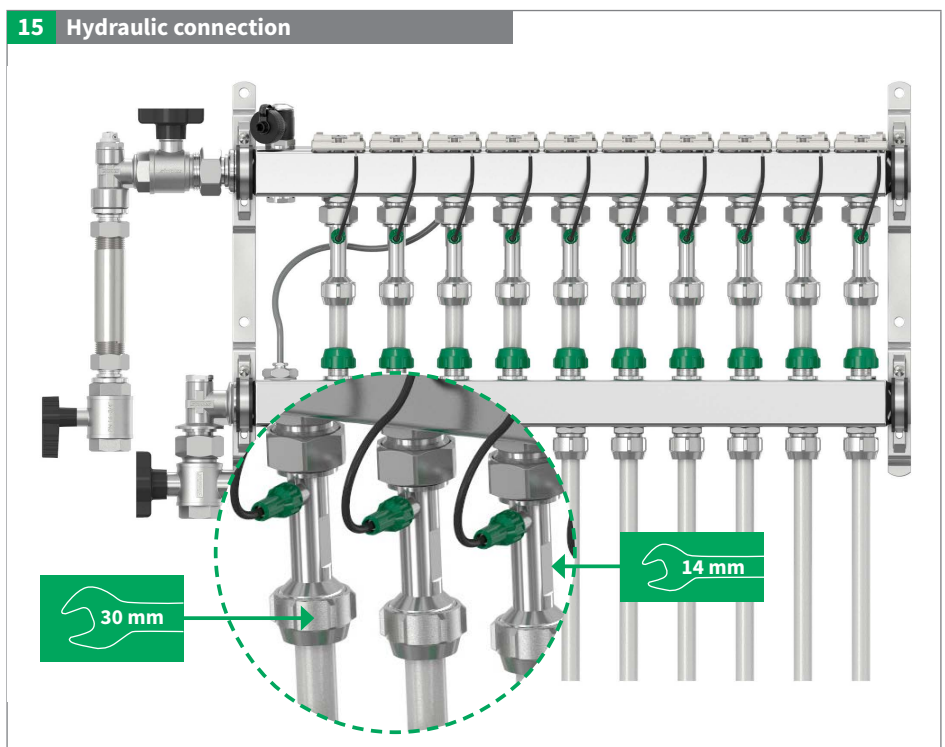

# Secos - Simplex Energy Control System

## 6.4.3. Manual operation of the valves

The valves can be operated using the handle caps or with an Allen key. In the return manifolds, the valves may only be operated manually with the drive units disassembled.

- 1 To open:** turn anticlockwise by 90°
- 2 To close:** turn clockwise by 90°

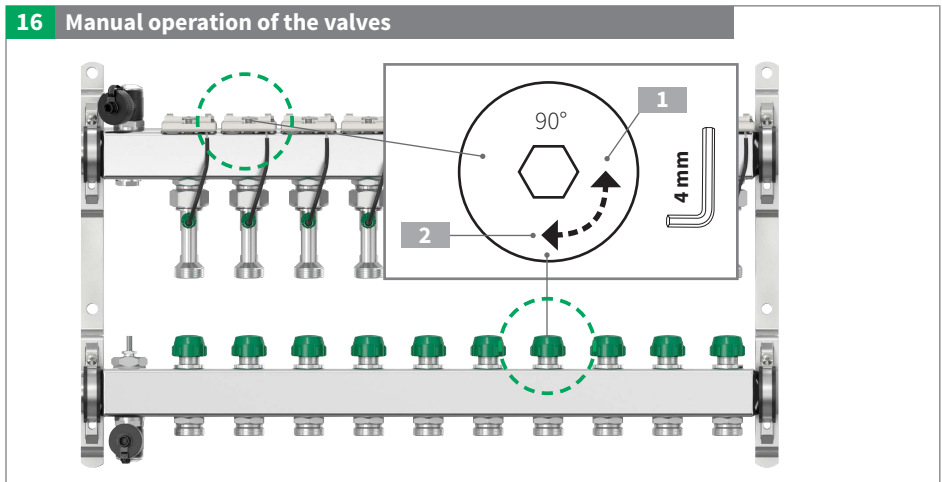

## 6.4.4. Leak-tightness test

Check all components of the system including all prefabricated elements for leaks and rework accordingly in the event of leakage. Adjust the test pressure and test duration to the respective piping system and the respective operating pressure. Fill the heating system only with filtered (if possible), treated water according to VDI 2035 and completely vent the system.

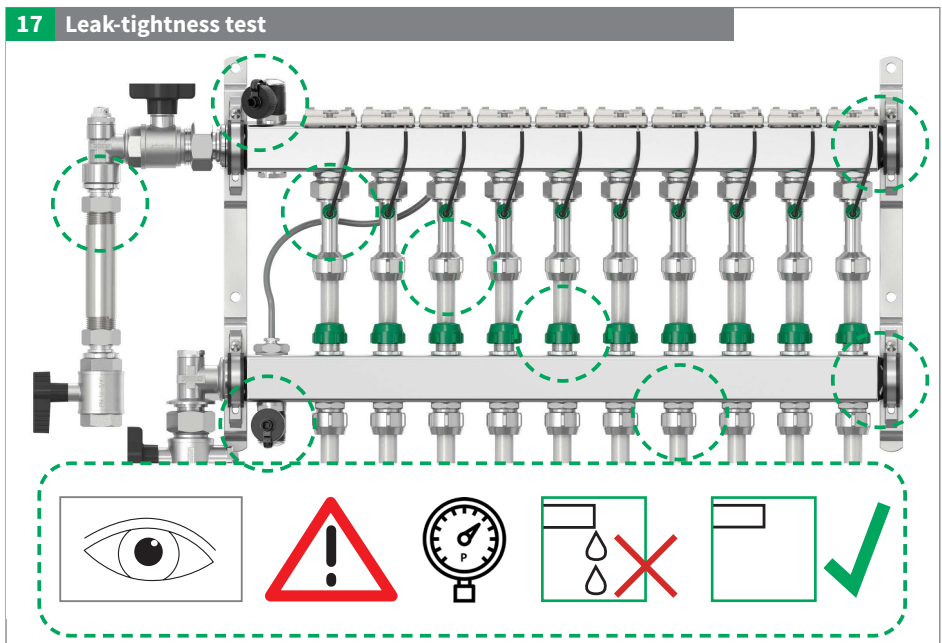

## 6.4.5. Protection for snap-on boards

Attach the protective card immediately after leak test

1. Remove from the insert
2. Fold at the intended fold line.
3. Completely cover the actuator plinth with sensor cable and Bus cable
4. Fix the protectic cover

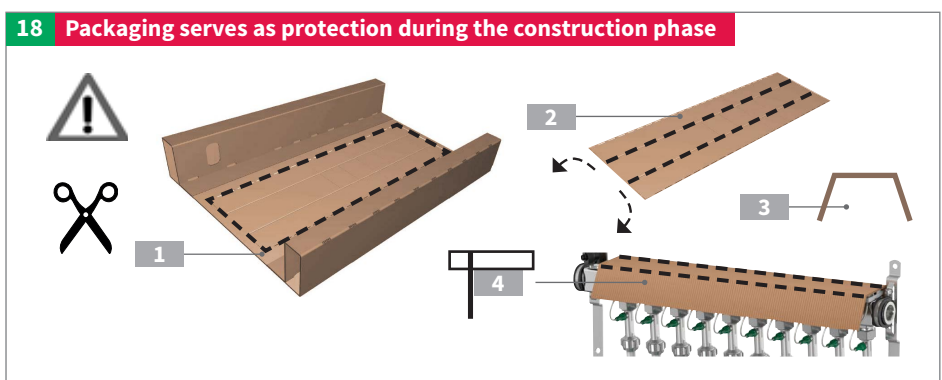



# Secos - Simplex Energy Control System

## 7. Installing the Secos energy saving controller

There are various ways of installing the Secos energy saving controller.

### Installation site

If the Secos system manifold is installed in the recommended position, the ideal installation location for the Secos energy saving controller is within reach of the preconfigured connection cables.

If required, the Bus cable can be extended with optional accessories. The cable of the Secos supply line temperature sensor can also be extended by the customer. For further information see the Electrical connection chapter.

### A - Mounting on top hat rail

Mount the controller on the top-hat rail located in the cabinet.

- 1** Mount below
- 2** Pull upwards
- 3** Press to the rear and snap in at the top

To disassemble, press the controller upwards and pull it forward at the top. Then unscrew below.

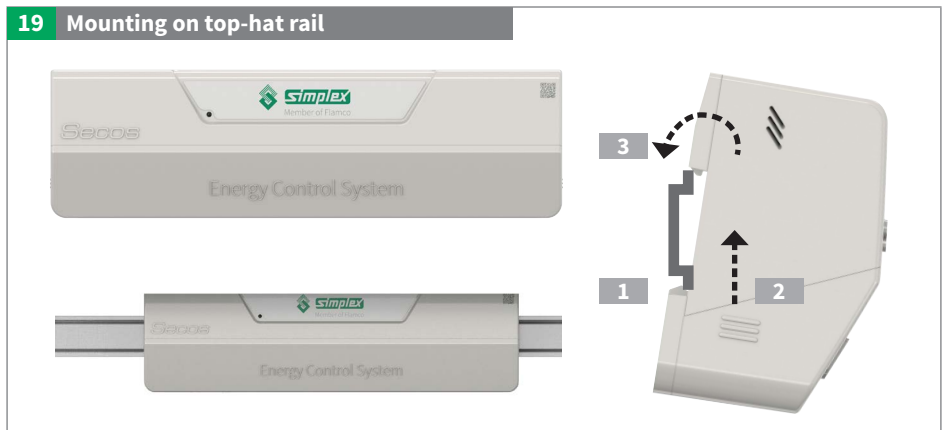

### B - Wall mounting

1. Hold the energy-saving controller unit against the wall and mark fixing points on the wall.
2. Fasten with appropriate fasteners (dowels, screws provided by customer).

<b>A</b> 298.5 mm	<b>E</b> 20.0 mm
<b>B</b> 82.9 mm	<b>F</b> 23.2 mm
<b>C</b> 87.2 mm	<b>G</b> 15.0 mm
<b>D</b> 128.4 mm	<b>H</b> 22.5 mm

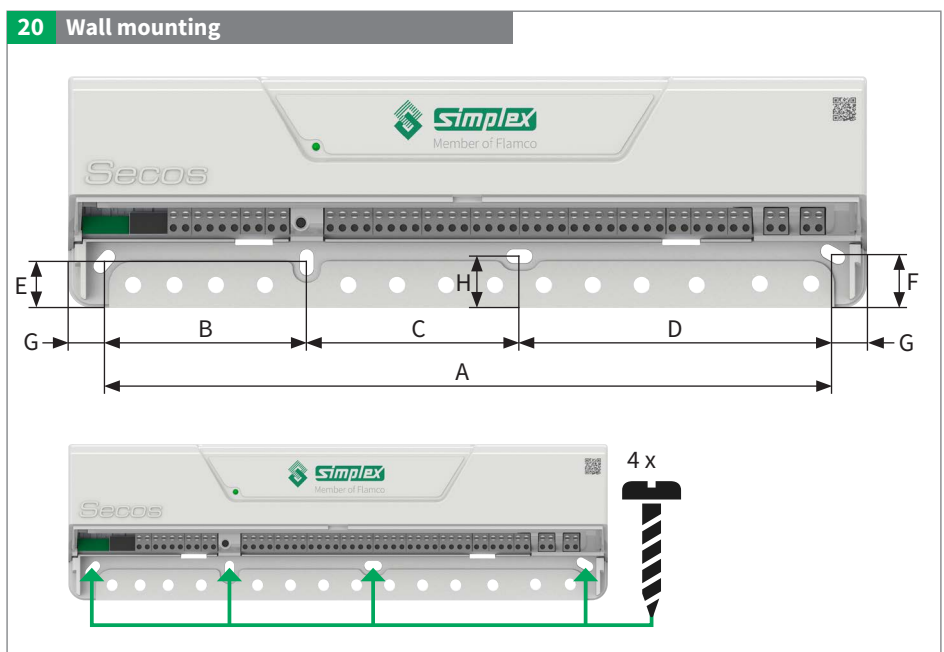



# Secos - Simplex Energy Control System

## 8. Electrical connection

### 8.1. General note on connection

#### General

Work on the electrical system and the opening of electrical housings may only be carried out when the system is de-energised and only by authorised specialist personnel. Ensure correct terminal assignment and polarity. Protect the electrical components against overvoltage.



Improper electrical connection may result in danger to life through electric shock.

- ▶ Electrical connection should only be carried out by an electrician approved by the local power supply company and in accordance with the locally applicable regulations.
- ▶ Disconnect the supply voltage before working.
- ▶ Do not open the housing parts!

### 8.2. Connection terminals in the energy saving controller

To install, simply push the cable in as far as it will go. To disassemble, press the button and pull out the cable.

#### Spring terminal

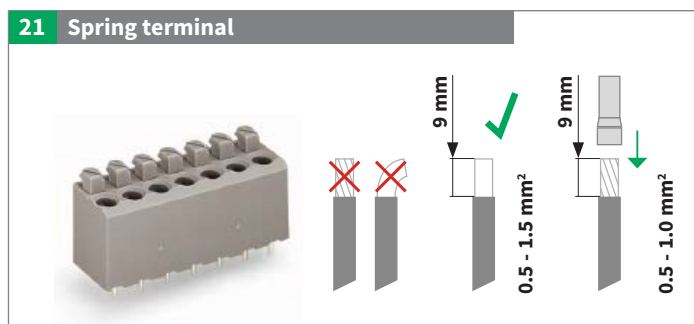

#### Screw terminal

Multiple assignment is possible

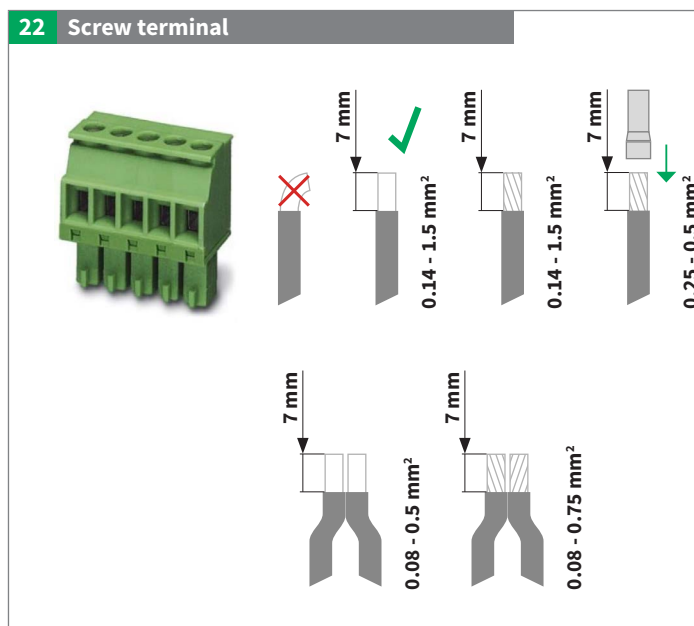



# Secos - Simplex Energy Control System

## 8.3. Connection diagram and terminal assignment

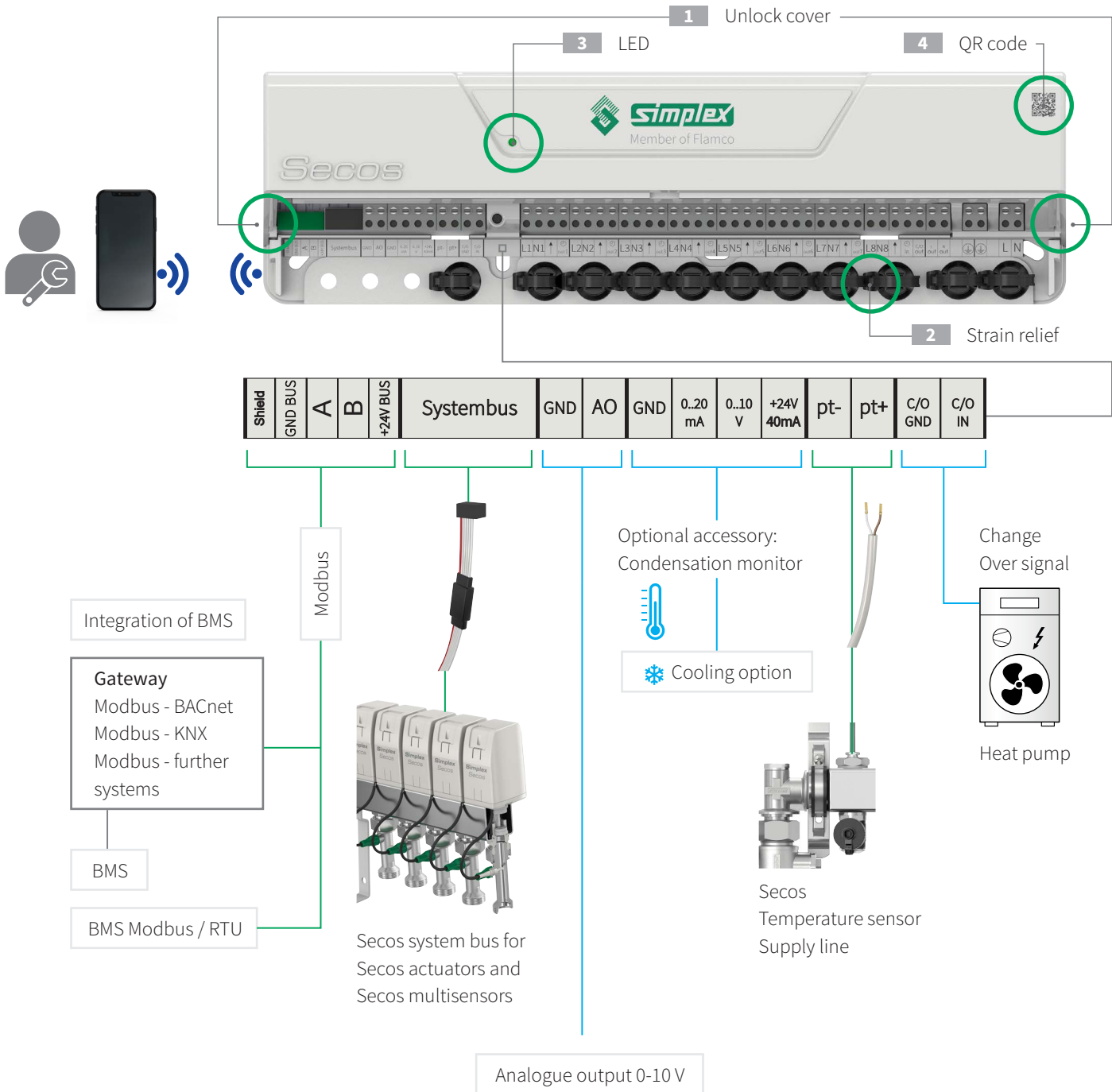

# Secos - Simplex Energy Control System

- 1 To remove the terminal cover, press it in at the side and release.
- 2 To protect the cables from strain, fix them with cable ties through the eyelets.
- 3 LED for indication of the operating states.
- 4 Sticker with QR code, serial number and passkey.

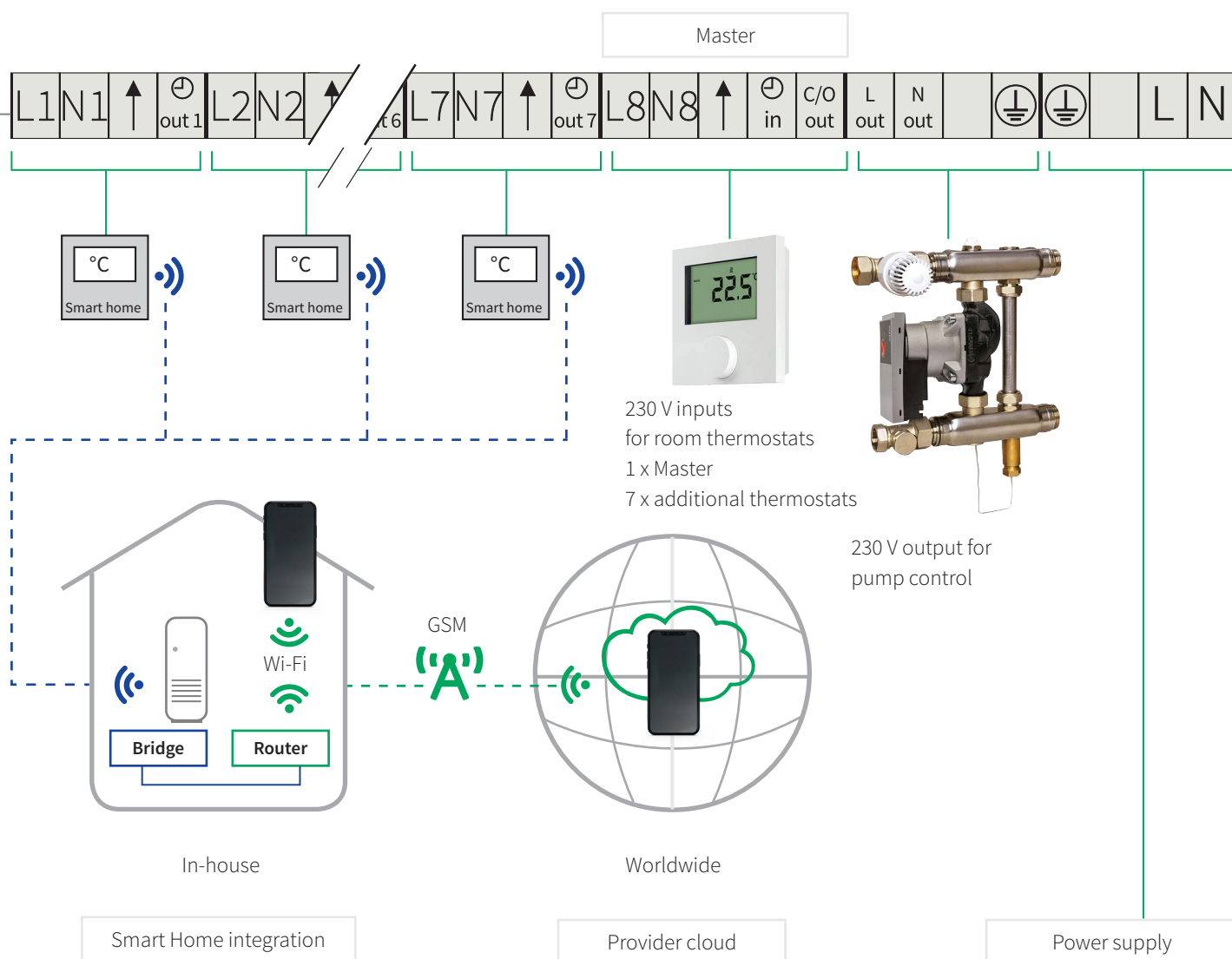



# Secos - Simplex Energy Control System

Terminal designation	Description	
Shield	Screen interface	Interface to building management systems (BMS) and other systems. Table with data points available in a separate document "Connectivity Guide". The document can be downloaded from the following address: <a href="http://www.simplex-armaturen.de/manuals/secos">www.simplex-armaturen.de/manuals/secos</a> .
GND BUS	Ground interface	
A	Channel A for data communication interface	
B	Channel B for data communication interface	
+24V BUS	Power supply interface	
System bus	Reverse-polarity-protected plug to the system manifold	
GND	Ground analogue output switching valve 0 - 10 V	
AO	Signal analogue output switching valve 0 - 10 V	
GND	Ground external condensation monitor	
0..20 mA	-	
0..10V	Input signal external condensation monitor	
+24V 40mA	Power supply of external condensation monitor	
pt-	Temperature sensor for supply line, polarity freely selectable	
pt+	Temperature sensor for supply line, polarity freely selectable	
C/O GND	Ground changeover (potential-free)	
C/O IN	Input signal changeover (potential-free)	
L1 - L8	Power supply of the room thermostats	
N1 - N8	Neutral conductor of the room thermostats	
↑	Switching signal of the respective room thermostats	
⊖ out 1 - 7	Output lowering signal for room thermostat 1 - 7 (slave)	
⊖ in	Input lowering signal from room thermostat 8 (master)	
C/O out	Changeover signal for display on room thermostat 8 (Master)	
L out	Phase pump for 230 V output	
N out	Neutral conductor for 230 V output	
⊕	Protective conductor for 230 V output	
⊕	Protective conductor for power supply system	
L	Phase energy supply system	
N	Neutral conductor for power supply system	



# Secos - Simplex Energy Control System

## 8.4. Power supply

- ▶ Ensure correct polarity
- ▶ If intended or prescribed for pumps, connect the protective earth conductor to the protective earth connection terminals of the controller. Observe the following points: Ensure that the protective earth conductor is also connected to the controller on the power supply side.
- ▶ Strain relief using flexible cables required: the enclosed cable ties must be used and tightened so that the cable cannot come loose.

## 8.5. Connect Secos temperature sensor for supply line

- a. When connecting to the controller, it is not necessary to pay attention to polarity.  
A cable with  $2 \times 0.5 \text{ mm}^2$  can be used to extend the sensor up to 2 m.  
Sensor is already mounted in immersion sleeve.

## 8.6. Connect Secos system bus

- a. Insert plug, if necessary use extension (optional accessory)
- b. 1x Bus cable ready to plug in, twist-proof.



# Secos - Simplex Energy Control System

## 8.7. Connecting room thermostats



Improper electrical connection may result in danger to life through electric shock.

- ▶ Electrical connection should only be carried out by an electrician approved by the local power supply company and in accordance with the locally applicable regulations.
- ▶ Disconnect the supply voltage before working.
- ▶ Do not open the housing parts!

Up to 8 room thermostats can be connected to the energy saving controller. If a room thermostat is used as master, it must be connected to terminal location 8.

The remaining terminal locations 1 - 7 can be used as required. All heating circuits are assigned to the room thermostats in the app.

Both 2-point room thermostats and room thermostats with PWM characteristic can be connected and utilised.

Only 230V room thermostats may be connected.

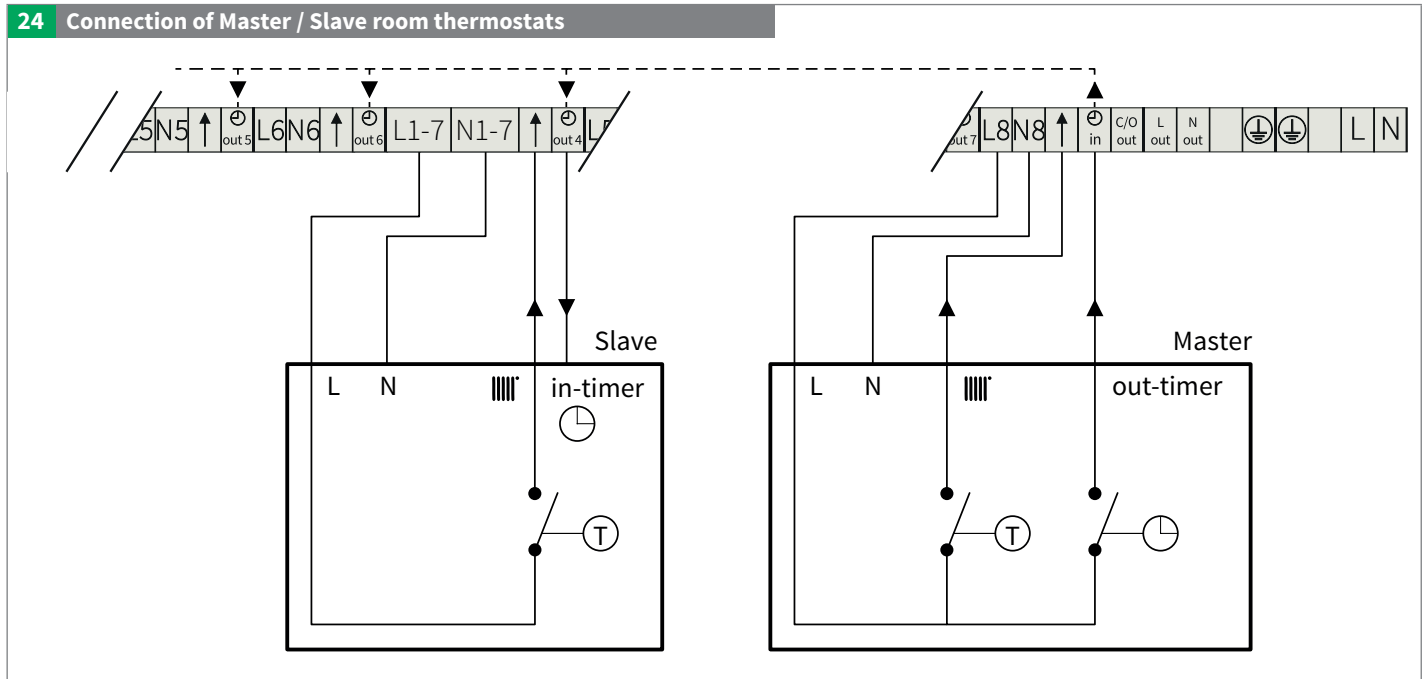
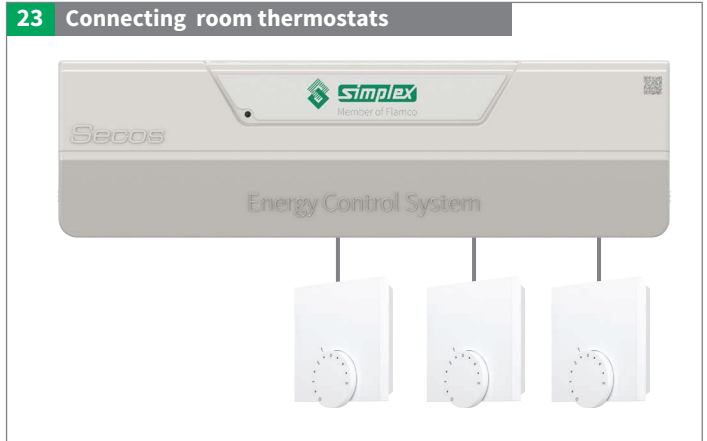

### Set-back operation for room thermostats

Thermostat with set-back output is connected to terminal block 8. Thermostats with set-back input use this signal via the respective connection, terminal blocks 1 to 7. ⌚

# Secos - Simplex Energy Control System

## 25 Connection of room thermostats with cooling operation

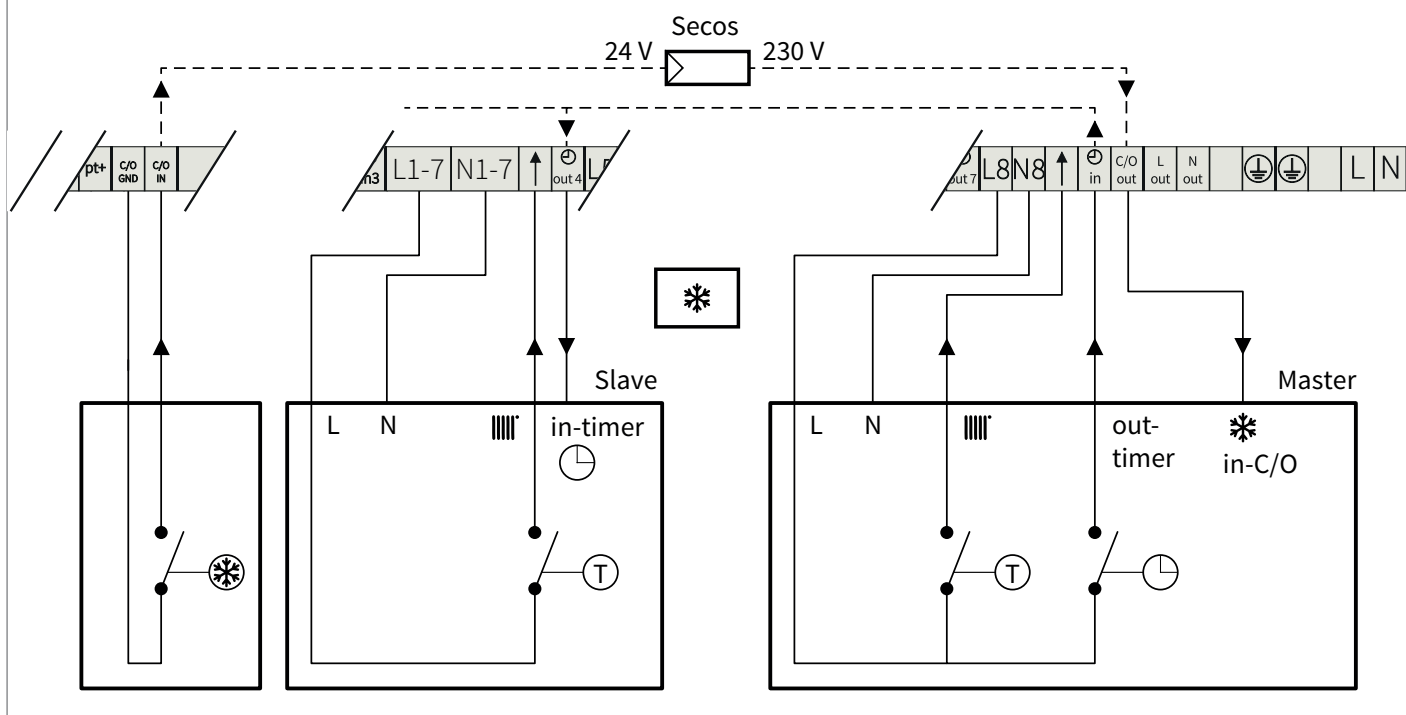

The energy-saving controller registers the cooling mode via the C/O IN input and can control the individual thermal circuits accordingly.

### Auto-inverting

In the app you can set whether the room thermostat signal should be inverted. With "Auto-inverting", the room thermostat automatically detects whether the system is in cooling mode and automatically carries out signal processing (prerequisite: c/o out of the energy-saving controller is connected to the master room thermostat).

### Non-inverting

With "Non-inverting" there is no connection between the c/o out and the room thermostat, or the room thermostat does not have a corresponding remote station. In this case, the controller inverts the room thermostat signals when switching to cooling mode (signal from cold source at c/o in).



# Secos - Simplex Energy Control System

## 8.8. Connect the remaining cables

Supply line temperature, bus cable for activators, if necessary c/o, if necessary ext. Condensation monitor, if necessary MODBUS, if necessary c/o valve 0-10V).

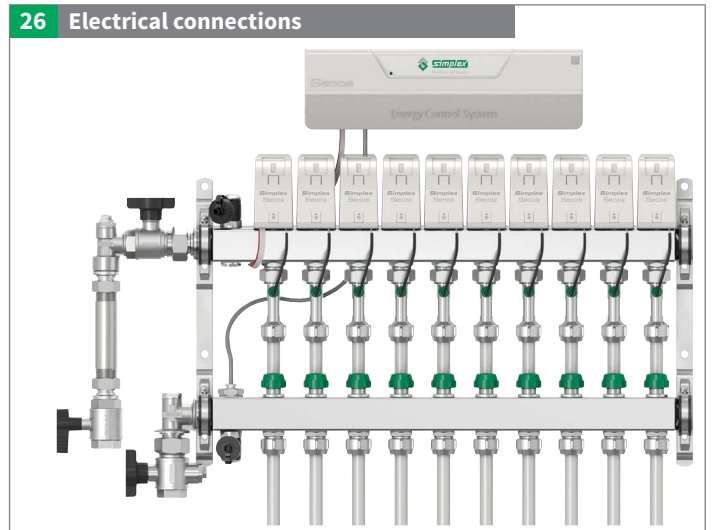

## 8.9. Connect external condensation monitor (optional accessory)

Only valid for Simplex accessories.

If other condensation monitors are used, it must be ensured that the voltage supply of the condensation monitor is taken from the energy saving controller and that a potential-free changeover contact is then fed back to a 0..10V interface.

If the external condensation monitor is triggered, all valves are closed and the pump interface is deactivated. As soon as the condensation monitor reports no further condensation, the system returns to regular operation.

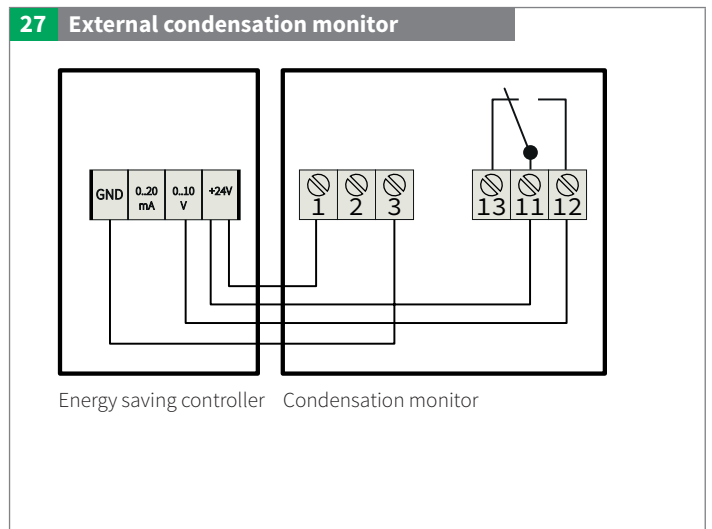





# Secos - Simplex Energy Control System

## 8.10. Installing Secos actuators



EXERCISE CAUTION during installation!

- ▶ The high-quality electronics of the actuator must be installed with appropriate care!
- ▶ Pins could be bent. This can result in the sensor or the complete drive no longer making contact.

### A - Installing the actuator

**Snap-on:** Plug-in technology for mechanical and electrical connection with just one click for error-free and time-saving installation

- 1 Set up carefully
- 2 Feel the spindle and align the housing flush with the snap-on board by turning it slightly.
- 3 Press the actuator downwards until it perceptibly locks into place.

#### 28 Installing the actuator

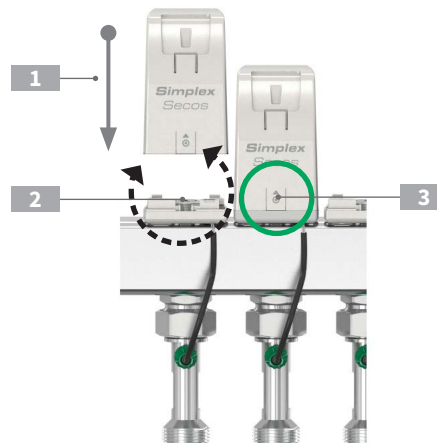

### B - Dismantling the actuator

- 1 To unlock the actuator, press at the marked point
- 2 and lift out at the same time

#### Note:

When reassembling, the actuators must be placed back on their respective snap-on boards.

Otherwise the actuators will have to be reassigned to function as expected.

After reinstallation, the energy saving controller must be restarted.

#### 29 Removing the actuator

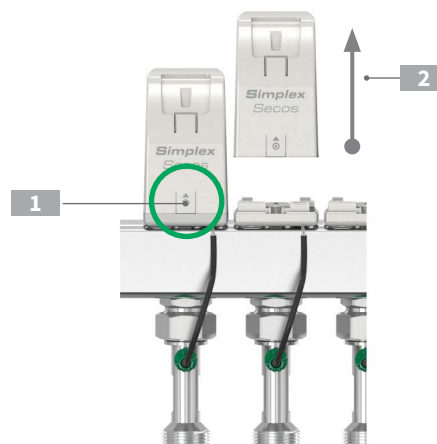



# Secos - Simplex Energy Control System

## 9. Commissioning

The following requirements must be met for successful commissioning:

- ▶ All components of the system are installed and assembled.
- ▶ The entire system is leak-tight.
- ▶ All necessary electrical connections have been made.
- ▶ A terminal device (tablet / smartphone) is available with the Flamconnect app installed.

### 9.1. Flamconnect app



- ▶ The Secos energy-saving controller can only be set and operated via a smart device with the Flamconnect app installed.
- ▶ One smart device can be connected to one controller at a time.
- ▶ The app is the tool for the expert for commissioning, logging, monitoring and diagnosis.

Download app:



For system requirements, see description in the respective App Store

- a. Play-Store - Android version
- b. iOS App Store - Apple version

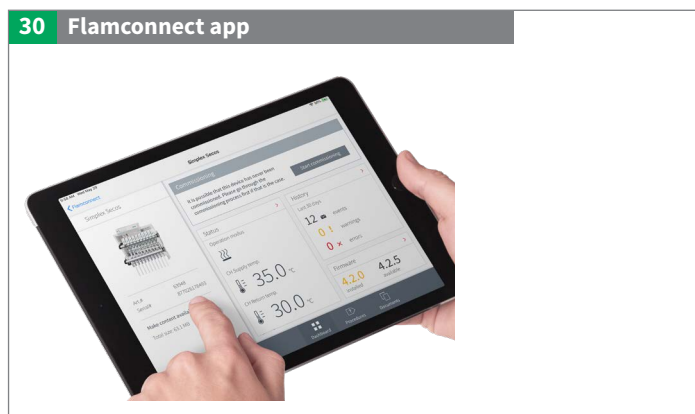

# Secos - Simplex Energy Control System

## 9.2. Perform commissioning

In the Flamconnect app, you will be guided step-by-step through the commissioning process.

The settings can be changed later at any time via the app.

- 1 Supply **controller** with power
- 2 **Open the Flamconnect app**
- 3 Scan **QR code** of controller
  - 1 Label with QR Code
- 4 **Enter connection code**
  - 2 Passkey: Input required to pair the smart device with the controller.

### 5 Configuration

Follow the further steps in the app:

- Go through the checklist to ensure the conditions for operation have been met.
- Identify actuators starting from the left
- Parameterisation of the system (operating mode heating / cooling / both, output per room or flow rate per heating circuit)
- General settings and system balancing function
- Assignment of circuits and thermostats with input of heating load / volume flows, cooling function, radiator thermostats.
- It is also possible to operate heating circuits without the assignment of a room thermostat. However, this requires manual entry of the desired power level [1 - 100 %].

1 **LED:** Display of the operating statuses

2 **Key** to identify the actuators

After successful identification, the actuators may no longer be exchanged with each other. If an exchange is necessary, the energy saving controller must be restarted and the activators must be identified and re-assigned.

### 6 Set / activate functions

**Automatic flushing function:** (see chapter on Operation)

Connect the flushing pump in the direction of flow. Flushing of the individual circuits now takes place automatically, in series, until this has been successfully carried out and confirmed by the operator.

(Connection to the smart device is not necessary during the whole process)

**Screed protocol function:** (see chapter on Operation)

After commissioning, the screed protocol function can be activated via the Flamconnect app.

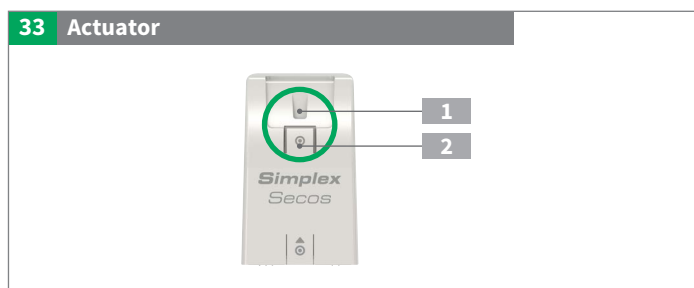
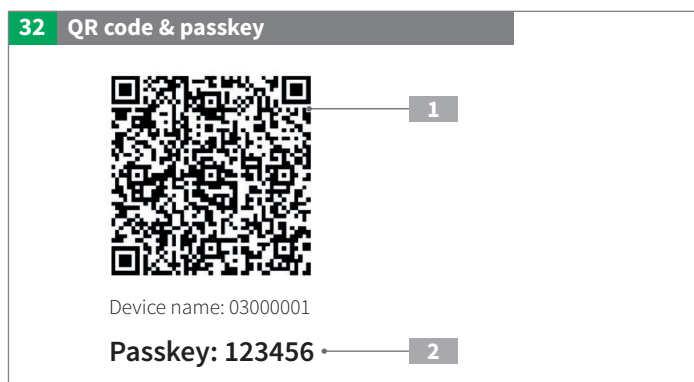
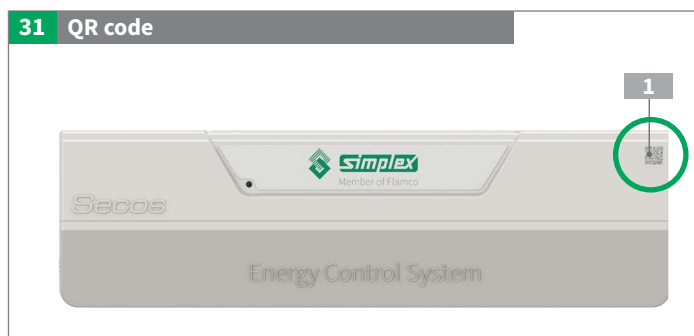



# Secos - Simplex Energy Control System

## 10. Operation

### 10.1. Energy saving controller

The Flamconnect app is essential for setting functions and calling up detailed information on the individual operating states.

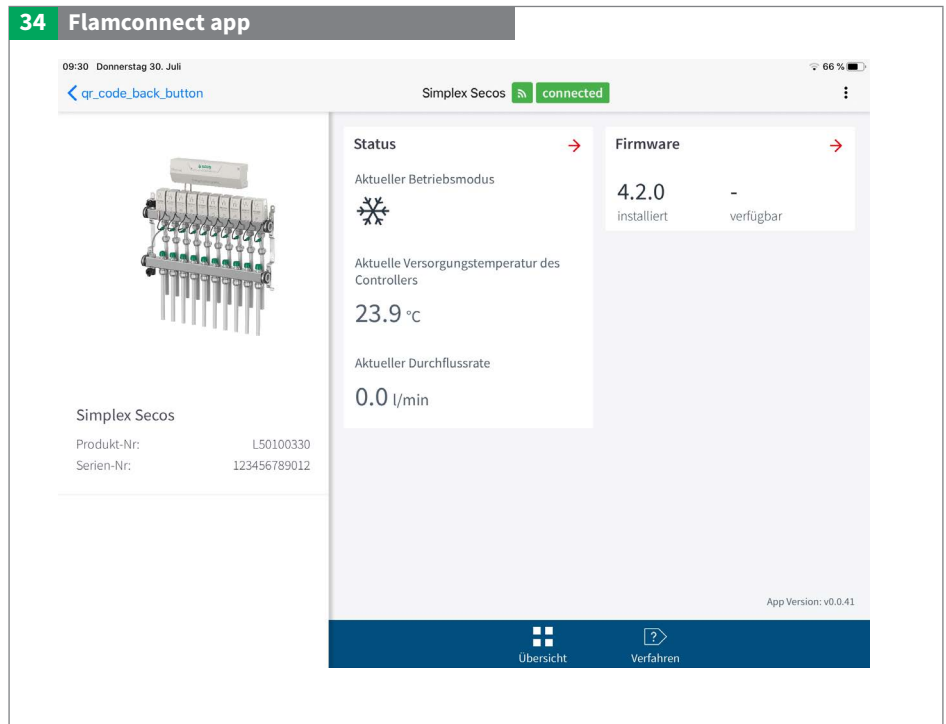

### Signalling

#### Status LED:

The energy saving controller contains a status LED to signal operating states.

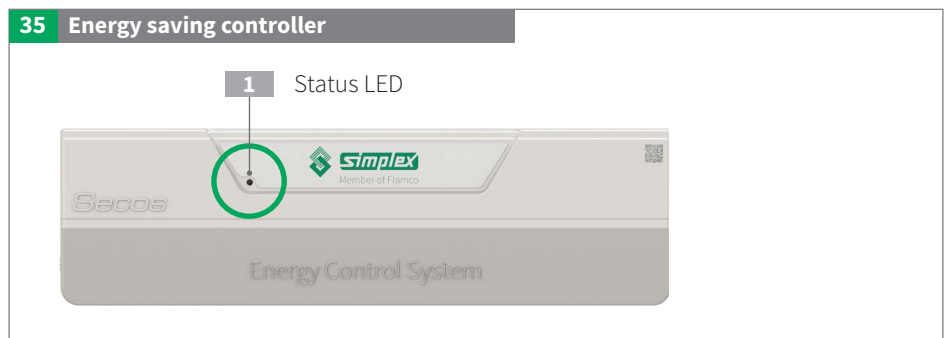

**Status LED:** The energy saving controller contains a status LED to signal operating states.

**Model:** Two-colour LED red / green.

	Status	Duration	Information
●	Green	Permanent	Ready for operation OK
⊙	Green	Flashing	Commissioning required
○	Off	Off	Not ready for operation LED is off, e.g. if commissioning has not been completed.
⊙	Red	Flashing	Warning, see chapter on Troubleshooting, LED flashes red 1 x per second
●	Red	Permanent	Error, see chapter on Fault-finding / Troubleshooting

# Secos - Simplex Energy Control System

## 10.2. Actuator

### Signalling

**Status LED:** The module has a two-colour LED red / green to signal operating states.

- 1** LED: Operating states Actuator
- 2** Key to identify the actuators

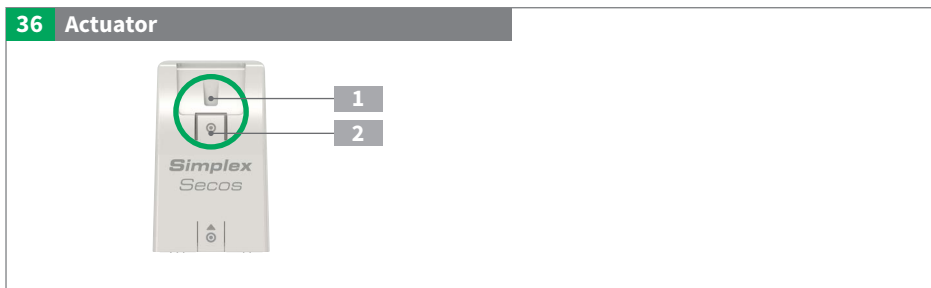

	Status	Duration	Information
○	Off	-	Condition good
⊗	Green	Flashing	Valve in motion
⊗	Red	Flashing	Warning, see chapter on Fault-finding / Troubleshooting
●	Red	Permanent	Error, see chapter on Fault-finding / Troubleshooting



# Secos - Simplex Energy Control System

## 10.3. Functions

To set or activate the functions, the energy saving controller must be connected to a tablet or smartphone via the Flamconnect app.

### 10.3.1. Flushing function

The flushing function is usually required by the installer when the heating system is commissioned. During flushing, the air from the heating circuits is flushed and separated. The heating water is pumped through the heating circuits in series at maximum speed to flush air bubbles out of the pipes. The automatic flushing process must be started in the app and will then run automatically and independently of the app.

At the end of the flushing process, the flushing function must be terminated in the app again. Only then does the energy-saving controller go into normal operation mode.

#### Flushing process

- 1 Return line
- 2 Supply line

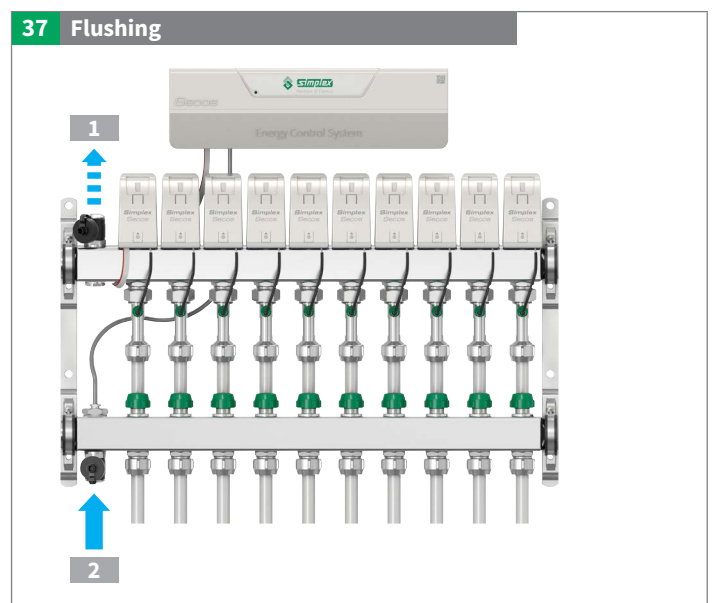

#### Signalling on the energy saving controller

**Status LED:** During the flushing function, the LED on the energy saving controller flashes green  slowly about 1x per second.

After successful completion of the function, the LED lights up green .

After completion and in the event of an error, the red  LED lights up. In this case, please repeat the procedure or flush manually.

#### Signalling on the actuator

**Status LED:** LED on the valve of the heating circuit that is being flushed flashes green  fast about 2x per second.

Flushing process OK = LED green .

Flushing process not OK = LED red . In this case, please repeat the procedure or flush manually.



# Secos - Simplex Energy Control System

## 10.3.2. Screed log

- 1 Return line
- 2 Supply line

After commissioning, the "Screed protocol" function can be activated.

The supply line temperature is recorded at regular intervals. The data can then be used to create the screed heating log.

This function can be activated even if no actuators have yet been installed. However, it must be ensured that all valves including all supply line and return valves are open.

If the actuators are already installed, they must be removed and the valve opened manually. The sequence of the actuators must not be confused if commissioning has already been carried out.

Otherwise, the actuators will have to be reassigned.

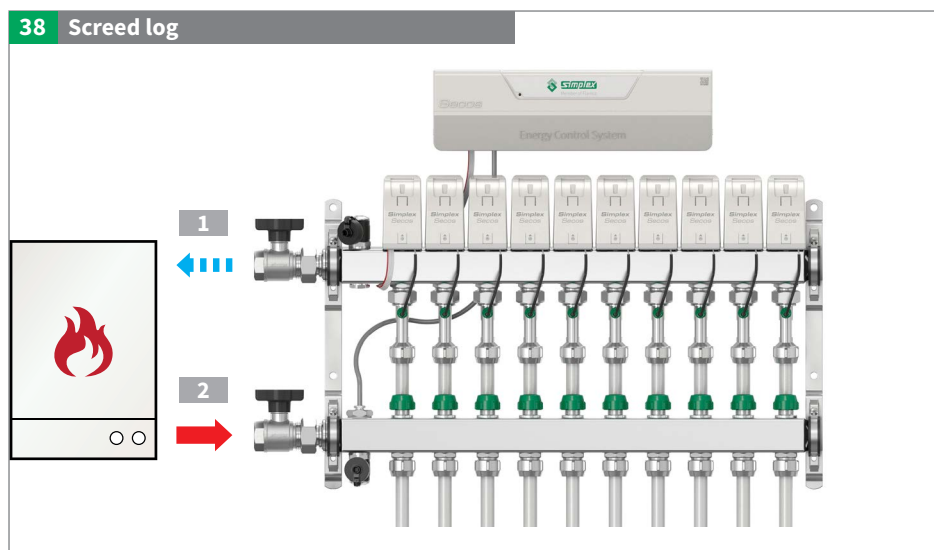

## 10.3.3. Valve and pump protection function

To ensure operational safety, the valves and the pump of the fixed-value control set are moved automatically during longer periods of inactivity. After a power failure, an automatic reference run is performed. We therefore recommend keeping the unit permanently under power.

## 10.3.4. Function of switching valve

This function enables individual control of a switching valve via the 0-10 V output. The configuration takes place in the app under "Advanced Function".

## 10.3.5. Function of radiators

If radiators are connected to the heating circuits, they can be parameterised with different properties:

- a. Radiators without thermostatic valve: These are controlled similarly to surface heating circuits via the respective room thermostat.
- b. Radiators with thermostatic valve / thermostatic head on the radiator: In this case, no room thermostat is assigned to the circuit. The valve of the corresponding heating circuit is permanently opened and hydraulically balanced. The control is based on the design value [W]. The heating circuit is opened by means of the thermostatic valve / thermostatic head.



# Secos - Simplex Energy Control System

## 10.4. Function monitoring

### 10.4.1. Supply line temperature

If the maximum permissible supply line temperature (factory setting 55 °C) is exceeded in heating mode, all valves are closed.

In cooling mode, all valves are closed if the minimum permissible supply line temperature of 15 °C is not reached.

### 10.4.2. Comparison of supply line / return line temperature

During heating operation, the spread between supply and return line temperature is constantly monitored. If the temperature in the return line rises above the supply line temperature, the corresponding valve is closed.

## 10.5. Data export

The values set or recorded in the energy saving controller can be conveniently exported via the Flamconnect app and then used for further logging purposes such as the commissioning log or the screed heating log.

For this purpose the exported file can be imported into the respective template.

The templates can be found at: <https://simplex-armaturen.de/manuals/secos>



# Secos - Simplex Energy Control System

## 11. Maintenance / service

For maintenance and in case of service, a connection via the app is necessary to view the current status, the error history and to check and correct the causes. A general visual inspection of the entire system, in particular for leaks, must also be carried out.

### 11.1. Maintenance interval:

Irrespective of desired intervals, it is recommended that the system be checked at least once a year by a specialist. Maintenance costs are usually amortized, meaning that unnecessary repair costs are often avoided, by this preventative maintenance, and therefore ongoing costs are reduced.

### 11.2. Drainage, venting and shut-off possibilities

#### Flushing process

- 1 Shutting off
- 2 Flushing / venting
- 3 Flushing / draining

If flushing is required, this can be done conveniently using the automatic flush function.

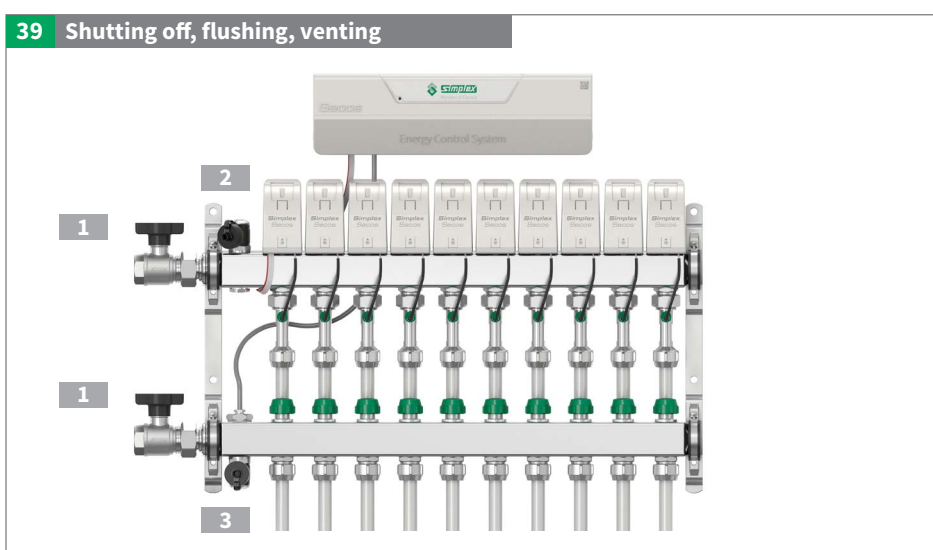

### 11.3. Replacing multisensors

- 1 Depressurise the system
- 2 Remove actuator (see chapter on Installing the Secos actuator)
- 3 Carefully loosen the plug by opening out the catches and pressing the plug from above. The Bus cable must not be damaged. If necessary, press the Bus cable slightly to the side with a plastic object to release the sensor cable.
- 4 Remove cap
- 5 Replace sensor



Fix the sensor cable so that the sensor cable does not twist while the sensor cap is being tightened

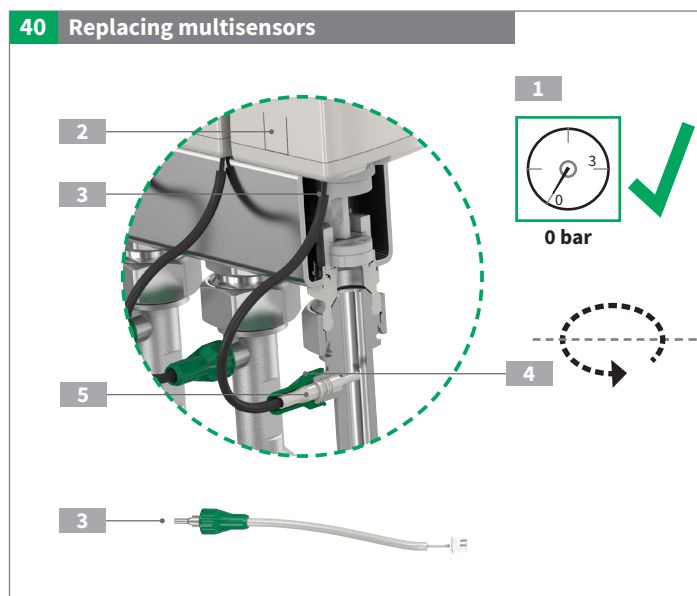







# Secos - Simplex Energy Control System



## 12. Troubleshooting / fault elimination

Display in the app		Display on the control unit	Display on the actuator	Problem	Possible causes	Corrective actions
Code	Message	Signal	Signal			
0	X	-	●	Actuator is not moving in circuit [heating circuit number]	- Actuator defective - Motor wiring defective - System Bus wiring defective - Valve too stiff or blocked	- Call customer service - Check valve for smooth running - Replace actuator
1	X	-	●	Return line temperature not measurable in circuit [heating circuit number]	- Multi-sensor not connected - Sensor defective - Wiring defective	- Call customer service - Replace multi-sensor - Check wiring
2	X	-	●	Flow rate not measurable in circuit [heating circuit number]	- Multi-sensor not connected - Sensor defective - Wiring defective	- Call customer service - Replace multi-sensor - Check wiring
3	!	☀	-	Condensation detected	- Value has fallen below dew point - Condensation monitor has detected condensate formation and triggered alarm - Supply line temperature in cooling mode too low	- Wait until condensation evaporates- Increase supply line temperature in cooling mode - Contact customer service if necessary
4	!	☀	-	No flow with open valves	- Pump is not running - Primary ball valves closed - Ceramic valves in supply line closed - Air in system - Flow externally blocked	- Call customer service - Check valve positions / settings on the heat source - Vent / flush the system
5	X	●	-	Supply line temperature exceeded	- Maximum permitted supply line temperature exceeded	- Check settings on the heat generator
6	X	●	-	Supply line temperature 999 °C	- Supply line temperature sensor not connected or defective (interruption) - Wiring defective	- Call customer service - Check wiring - Replace supply line temperature sensor
7	!	☀	-	Supply line temperature has fallen below minimum permissible level	During cooling operation: Cold source too low	- Check settings on the heat generator / cold source
8	X	●	-	Supply line temperature 000 °C	- Supply line temperature sensor defective (short circuit) - Wiring defective	- Call customer service - Check wiring - Replace supply line temperature sensor
9	X	●	-	Actuators not recognized	- Actuator not connected - Wiring defective	- Check actuators for correct seating - Check wiring - Contact customer service if necessary

# Secos - Simplex Energy Control System

Display in the app		Display on the control unit	Display on the actuator	Problem	Possible causes	Corrective actions
Code	Message	Signal	Signal			
10	!		-	Unauthorised flow in circuit [heating circuit number]	- Reference run faulty - Disc valve does not close - Multi-sensor delivering incorrect measured value	- Restart energy saving controller: Interrupt power supply for approx. 10 seconds
11	!		-	Reference run not successful in circuit [heating circuit number]	- Reference run not completely performed	- Restart energy saving controller: Interrupt power supply for approx. 10 seconds
12	X	-		Flushing not successful in heating circuit [heating circuit number]	- Valve in the supply line bar closed	- Check valve positions - Repeat flushing function
13	X			Flushing not successful in circuit [heating circuit number]	- Valve in supply line manifold closed - Flushing station not active	- Check valve positions - Check flushing station - Repeat flushing function

 Flashes    Lights up    Error    Warning

Possible sources of error that are not displayed in the energy saving controller and app		
Problem	Possible causes	Corrective actions
Valves are not opening in operating condition, no flow	- Supply line / return line have been connected in reversed order	- Ensure correct flow direction
 No connection	- Bluetooth not activated on the smart device - wrong or invalid passkey - distance too great	- Activate Bluetooth on the tablet or smartphone - Restart the app - Check or re-enter the passkey - Disconnect the energy saving controller from the power supply for at least 10 seconds - Check and ensure the power supply of the energy saving control - Restart the app - Re-enter the passkey
 Connection terminated	- Wrong or invalid passkey - Distance too great	- Disconnect the energy saving controller from the power supply for at least 10 seconds. - Restart the app - Re-enter the passkey
QR code not readable	Bullet label damaged	Contact Simplex



# Secos - Simplex Energy Control System

## 13. FAQ

### 1. What is Secos?

Secos means Simplex Energy Control System and is a highly innovative control system for surface temperature control.

### 2. How does Secos work?

Due to a constant volume flow and temperature measurement in each heating circuit the hydraulic balancing values are optimally and immediately adjusted.

### 3. How does the commissioning take place?

When the Secos energy-saving controller is connected for the first time with the "Flamconnect" app, you will be prompted to perform the commissioning.

You will be guided step by step through the required process.

### 4. Do you need to set more?

The hydraulic adjustment starts to work at the point of input of the above-mentioned values. However, all settings can be modified and additional functions specified later.

### 5. Can conventional room thermostats be used?

Secos is very flexible and can be used with all 230V room thermostats which generate an analogue signal such as a two-point or PWM signal.

### 6. Do the valves stick?

No, the ceramic disc valves are designed, and the material selected, to ensure that the valves remain free, durable and reliable. Additionally, any longer downtimes of individual valves will be detected and the valves moved at periodic intervals, to maintain freedom.

### 7. How sensitive are the Secos multisensors?

The Secos multisensors do not contain any moving parts. They are therefore wear-free and function even with dirty water.

### 8. What happens in the event of a defect or fault?

In such an event, the Secos Energy Saving Controller will register a warning signal. Then, the smartphone or tablet which is connected via the Flamconnect app to the Secos energy saving controller can be used to carry out a detailed analysis.

### 9. How does flushing take place?

There is an automatic flushing program, which can conveniently be started after connection (e.g. using flushing equipment) via the "Flamconnect" app. The automatic flushing program flushes the heating circuits separately and automatically until a reliable and constant volume flow is detected by the Secos multisensors.

### 10. Can I also shut off heating circuits without a Secos actuator?

Yes, the Secos disc valves can be manually opened and closed in the supply and return lines.

### 11. Is Secos compatible with other laying systems?

Secos is compatible with all commercially available underfloor heating laying systems such as staple, nub plate, hook and loop, drywall, support matting and renovation systems

### 12. Can all underfloor heating pipes be used?

All commercially available underfloor heating pipes can be used. These are connected with the Secos system manifold using Eurocone compression fittings.

# Secos - Simplex Energy Control System

## 14. Spare parts and accessories

### 14.1. Spare part

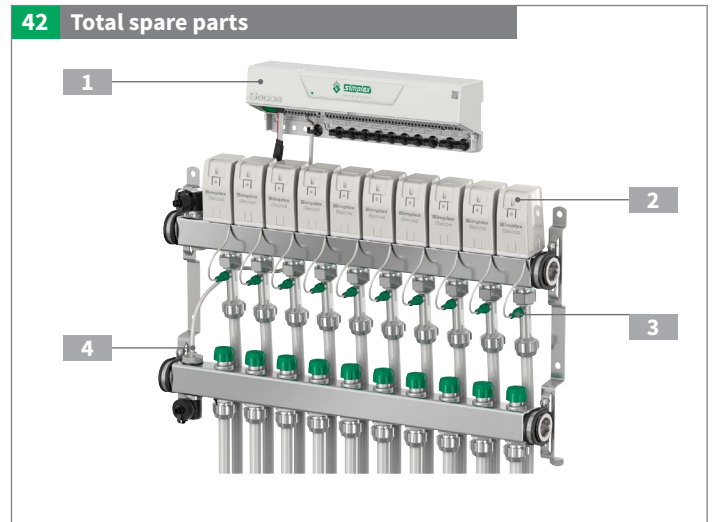
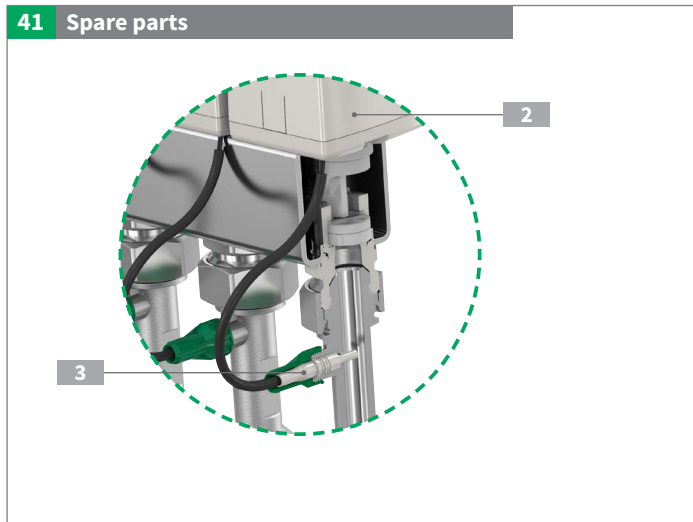

	Article no.	Article	Information
1	F18840	Secos energy saving controller	Energy saving controller for up to 8 room thermostats, up to 14 circuits
2	F18841	Secos actuator	for adjusting the ceramic disc valves
3	F18850	Secos multisensor	Multi-sensor with cable, plug and screw-on cap
4	F18852	Secos supply line temperature sensor	Supply line sensor without immersion sleeve

### 14.2. Accessories

Note: not included in the scope of delivery!

Article no.	Article	Information
F18854	Secos BUS extension for connection cable	Extension cable with plug for BUS connection (2m)
F18855	Secos external condensation monitor	External condensation monitor for decentralised application



# Secos - Simplex Energy Control System

## 15. Disposal

Separate products and packaging into their respective material groups (e.g. paper, metals, plastics or non-ferrous metals) and dispose of them in accordance with the applicable national legislation.

Electronic components, batteries and accumulators may not be disposed of in household waste, but must be disposed of properly in accordance with the applicable guidelines.

**Scope of application / note:** WEEE registration for the Waste Electrical Equipment Register: DE30940639

**Rules:** WEEE Directive 2012/19/EU

## 16. Contact persons and contacts

### Simplex Armaturen & Systeme GmbH

Isnyer Straße 28  
88260 Argenbühl  
Germany

Phone: +49 75 66 94 08-0  
Fax: +49 75 66 94 08-75

info@simplex-armaturen.de  
www.simplex-armaturen.de



# Secos - Simplex Energy Control System

## 17. Declaration of Conformity CE conformity

CE conformity	<p>Simplex Armaturen &amp; Systeme GmbH hereby declares that the product Simplex SECOS ESC is in conformity with the essential requirements and the other relevant provisions of Directives 2011/65/EU, 2014/30/EU and 2014/35/EU.</p> <p>The complete conformity assessment can be downloaded from the following address: <a href="http://www.simplex-armaturen.de/de/docfinder/conformity/">www.simplex-armaturen.de/de/docfinder/conformity/</a></p>
---------------	---

Our general terms and conditions of business and our guarantee conditions apply.

**Simplex Armaturen & Systeme GmbH**

Isnyer Straße 28  
D-88260 Argenbühl - Eisenharz

**T** +49 (0) 7566 9408-0  
**F** +49 (0) 7566 9408-75  
**E** secos@simplex-armaturen.de

Art.No. K80402220 Version 10/2020



In perfect harmony with  
Flowing Compositions

[www.floating-compositions.com](http://www.floating-compositions.com)

[www.simplex-armaturen.de](http://www.simplex-armaturen.de)

