



# Balanced Pressurisation Equipment

Flamcomat D0, D1, D2, D3, D4, D5 & D6

Grundfos PHP C0, C1, C2, C3, C4, C5 & C6

## Operation & Maintenance Manual

Rev 4.2

## Customer Details

Please fill in information future reference:

Company:	<input type="text"/>	Contact:	<input type="text"/>
Address:	<input type="text"/>	Tel No:	<input type="text"/>
		Fax No:	<input type="text"/>
Post Code:	<input type="text"/>	E-mail:	<input type="text"/>

## Equipment Details

Details of model and serial number may be found on the label

Model:	<input type="text"/>	Serial No:	<input type="text"/>
Purchase date:	<input type="text"/>	Purchased From:	<input type="text"/>

### Note:

It is highly recommended to have this equipment commissioned by a Flamco approved engineer. Any damage or loss incurred through incorrect commissioning by an unapproved engineer will not be covered by the warranty. If you wish for Flamco to arrange this please contact us. (See contact details)

Please see the warranty section for details.

Remember to fill in details for future use for re-commission unit.

Please be aware that the setup of this equipment is complex and cannot be carried out using telephone support. Service & Commissioning training is available for this equipment, price and availability on request. Alternatively please consider the use of the trained engineers and service partners already established throughout the UK.

## Commissioning Record

Top Controller				SPC (Balanced Pressurisation) Controller			
	As Found	On Completion			As Found	On Completion	
Cold Fill			Bar	System Set Pressure			Bar
High Set			Bar	Critical High Alarm			Bar
Low Set			Bar	Critical Low Alarm			Bar
Differential			Bar	Differential Pressure			Bar
Flood Limit			Mins	Safety Valve			Bar
P1 Count				Master Vessel Level			%
P1 Hours				Calibration Weight			Kg
P2 Count				Top-up Hours			Hours
P2 Hours				Degassing Mode			
Alarm Count				Zero Level Confirmed			Y/N
Power Interrupted				Flow Rest' Values			
Pulse			Y/N	Serial Number			
Excessive Start			Y/N	Master Vessel Size			Litres
Service			Y/N	Pump-set Type			
Pump Number							
Pump Type							
Pump Sense			Y/N				
Sensor Type							
SPC Controller			Y/N				
Glycol Unit			Y/N				
ID Number							
Relay Inversion			Y/N				
Overrun			Sec.				
HL Alarm			Y/N				
AutoReset							
Cascade							
Boost			Y/N				
Flomat			Y/N				

### NOTES

**Engineer Signature:** 
**Date:** 
 / 
 
 /

**Customer Signature:** 
**Date:** 
 / 
 
 /

**Commissioning certificate can be obtained please contact Flamco representative**

## Contents

Customer Details .....	2
Equipment Details .....	2
Commissioning Record .....	3
Warranty Statement.....	5
Environment .....	6
Safety .....	6
SPC Wiring – 230v - Single Phase - 50 Hz (SPCx-lw).....	22
SPC Wiring – 400v - Three Phase - 50 Hz (SPCx-hw).....	22
SPC Terminal Plan Glossary .....	23
Break down of parts .....	24
Installation Checks & Tasks.....	37
Flamcomat (PHP) Checklist.....	38
Commissioning Against a Running System .....	40
Initial Commissioning .....	41
SPC Controller Set-up .....	43
Topup Fault Codes .....	54
Shutdown procedure.....	55
Start-up Procedure .....	55
Maintenance.....	56
Topup Troubleshooting .....	61
SPC Fault Codes .....	65
Service Logs .....	75
Appendix 1.....	77
Warranty Details.....	78
Notes.....	79

This equipment is covered against manufacturing defects for 12 months from date of purchase from Flamco Limited.

**This warranty covers the replacement of parts or products, verified as having a manufacturing defect, when inspected at the St Helens factory.**

Flamco Limited reserves the right to inspect an installation to verify that the equipment has been installed in accordance with the written instructions.

**Any modifications to the supplied equipment must be approved in writing by Flamco Limited, failure to do so will invalidate the warranty.**

All goods are carefully tested and inspected before dispatch. Should any goods appear defective owing to faulty materials or manufacture, they must be returned to us for examination. If we (acting reasonably) agree they are defective, we shall replace them. This shall be our only obligation in relation to the defective goods, unless we have notified you in writing of any additional warranties we may provide and you have complied with all conditions attached to these warranties. Beyond this all conditions, warranties and representations expressed or implied by statute, common law or otherwise in relation to the Goods (save for the conditions implied by section 12 of the Sale of Goods Act 1979) are excluded from the Contract to the fullest extent permitted by law (if you are acting as a consumer please see paragraph below).

**Flamco Limited can only respond to warranty queries from its direct customer. If in doubt, please contact your installer to establish the supply chain.**

We are not liable for any indirect, special or consequential liabilities, losses, charges, damages, costs and expenses you suffer howsoever caused and including, without limitation, pure economic loss, loss of anticipated profits, goodwill, revenue, reputation, anticipated savings, management time, business receipts or contracts or losses or expenses resulting from third party claims. Nothing in these Conditions excludes or limits our liability (a) for death or personal injury caused by our negligence, (b) for our fraud or fraudulent misrepresentation or (c) for any matter which it would be illegal for us to exclude or attempt to exclude our liability. If you are acting as a consumer you will have additional statutory rights which we cannot contract out of and we are not excluding or limiting these rights.

## Environment

- It is not anticipated that this equipment will be exposed to adverse environmental conditions without additional protection.
- Site the equipment in a **Frost Free Area**.
- Ensure that 500mm of clear access is available around the equipment with dedicated clear access at the front of the pumpset cabinet and above the spill vessels.
- Flush the mains water supply pipe before connection to this equipment.
- An inline filter must be fitted to the inlet of the equipment if the mains water supply is suspected to contain debris.
- Please refer to BS 7074 for the installation code of practice.
- Maximum running conditions 40 °C and 70% humidity.

## Safety

- Electrical installation must be carried out by a **competent\*** person
- **WARNING – LIVE TERMINALS WITHIN THIS EQUIPMENT**
- Isolate the equipment before removing any covers
- **Do Not** make any electrical adjustments to the equipment unless it is isolated from the mains electrical supply
- **Do Not** operate with the electrical covers removed
- **Do Not** alter any internal pipe-work, this equipment is tested prior to Dispatch.
- **Do Not** obstruct and ventilation fans or apertures
- **Check** supply voltage and overload protection is correct
- **All** Electrical installations must be carried out in lines with BS7671:2008



### Warning

Within this manual there is reference to the symbol for 'Danger – Electric Current'

Disregarding these warnings may:

- Jeopardise Health
- Cause death, fire or other damage
- Lead to overloading of system components and permanent damage
- Impair the function of the equipment



**Warning:** This equipment contains sensitive electronic components which may be adversely affected by electrical installation testing. The equipment must be disconnected from the supply before carrying out electrical installation tests.

## Delivery of Goods

Buyers or their agents within the United Kingdom and Republic of Ireland must notify the carrier and Flamco UK in writing in the event of damage to or partial loss of goods within three days of delivery.

In the event of non-receipt of goods, both the carrier and Flamco UK Ltd must be notified in writing within ten days of receipt of invoice. Unless such notification is received, the goods will be deemed to have arrived in good condition and we shall not be liable upon and shall have the right to reject any claim in respect of any such damage, loss, shortage or non-receipt of goods.

## Transportation

Vessels are shipped horizontally within a disposable wooden frame, pumpsets are shipped upright on a disposable wooden pallet. Care must be taken to ensure the pallets, packaging and equipment does not bottom out, tip or rock causing damage or marking of the powder coated finish. Lifting lugs and points, when provided, will be clearly visible and marked. Do not stack equipment, once removed from the transportation packaging the equipment must be put into position.

## Unloading of goods

Due to the nature, size, weight, and shape of the goods, appropriate offloading equipment will be required on site, as well as any moving equipment such as winches, forklifts and trolleys. Please refer to your site health and safety officer for appropriate procedures.

## Storage

Once delivered this equipment must be stored appropriately, without exposure to adverse weather conditions and in a frost free area for the duration of the storage period. Water may remain within the unit following factory testing, in the event of a frost, sensitive electronic equipment may be damaged by the expansion of water as it turns to ice.

Storage conditions:	Temperature:	50 °C Max
	Humidity:	60 - 70% Max
	Protection against:	Sunlight, heat radiation and vibration
	Room conditions:	Closed, Frost free, Dry

## Appropriate Use

This equipment is designed for use on sealed heating and chilled systems, where the thermal expansion and contraction directly affects the fluid system volume.

This equipment is intended for use on balanced sealed heating and chilled systems where a closely maintained pressure is required.

Water based, sealed heating and chilled systems are in accordance with BS EN 12828:2003. For system temperatures exceeding 105 °C additional rules and regulations may apply, please contact the thermal system designer for confirmation.

## Commissioning Personnel

Commissioning must be carried out by a qualified person. This is defined as anyone who has successfully received professional training and guidance from the manufacturer of the equipment, Flamco UK. The qualified person is also expected to have sufficient knowledge and experience of relevant national safety standards.

## Installation Location

Access for unqualified and untrained personnel must be restricted or forbidden to this equipment.

The intended location for the equipment must ensure operation, service, maintenance, inspection, repair, installation and dismantling of the equipment can be carried out unhindered and in safety (**See Appendix 1 for example**).

Weight loadings must be checked to ensure the vessel and pumpset are stable throughout the operation life of the equipment.

A suitable drain point must be located within a practical distance of the spill vessel(s). In a service or fail condition it may be necessary to drain the fluid content of the spill vessel(s). This fluid may be up to 70°C under normal operating conditions, and over this temperature as a result of improper usage. Therefore a safe and appropriate drainage point is essential.

Care must be taken to ensure the equipment is not submerged in the event of a flood situation; internal components are not suitable for complete immersion in water and must be practically prevented from doing so.



## Emergency Stop

Directive 2006/42/EC requires an emergency stop facility is made available on the main power switch to the control unit. This separates the phases and neutral lines. Where additional Emergency Stop facilities are required, these are to be installed onsite and do not form part of the equipment supplied.

## Personal Protective Equipment (PPE)

PPE must be used when carrying out potentially dangerous work, including but not limited to, transportation of equipment, installation, commissioning and maintenance, please refer to your site health and safety officer for appropriate procedures and wears.



## Over Temperature

Equipment used in combination with the expansion automat must guarantee that the permitted operating temperature and the permitted fluid temperature cannot be exceeded. Excess pressure and temperature may lead to component overload, irreparable damage to components, loss of function and, as a result, to severe personal injury and damage to property. Regular checks/inspections of these safeguards must be carried out.

It is the responsibility of the end user to ensure appropriate installation of safety devices to protect equipment in such events as over pressurisation, over temperature and any other foreseeable system problems that may occur, to protect both the equipment and personnel.

## System Fluid

Fluid that is non flammable, does not contain solids or long fibre components and does not present danger to operations due to its contents, and will not affect or damage the water bearing components.

The Flamcomat Equipment is suitable for water glycol mixes up to and including 50:50 mix (please note that any addition of glycol in to water vastly increases the expansion coefficient, if the original sizing has not been done on the correct percentage mix then the equipment may be under sized!).

Operation with improper media can lead to impaired function, damage to components and, as a consequence, to serious personal injury and damage.

**\*Definition: Competent person:** A person who possesses sufficient technical knowledge, relevant practical skills and experience for the nature of the (electrical) Work undertaken and is able at all times to prevent danger, and where appropriate, injury to him/herself and others

## Safeguards

The equipment supplied is equipped with the required safety devices. To test their effectiveness or restore the set-up conditions, the equipment must first be taken out of service. Taking the system out of service implies that the electrical power and hydraulics must be isolated.

Mechanical hazards:



The fan wheel casing on the pump protects operators from personal injury from moving parts. Before commissioning, check that it is fit for purpose and fixed in place. Expansion automats with protective casings are protected against dirt, prevent unauthorized operation and minimize noise emission.

Electrical hazards:



The protection class of electrically-operated components prevents personal injury by electrocution, which can be deadly. The protection class is usually IP54 (5: access with wire impossible, dust protected, 4: protected against splashing water). The control unit enclosure, the cover of the pump feed, the threaded cable glands and the valve connector plugs must be inspected for effectiveness

prior to commissioning. The installed pressure and volume sensors are operated with protective extra-low voltage.

Avoid welding work on additional equipment which is electrically connected to the control unit. Stray welding current or an improper earth connection could lead to the danger of fire and damage to parts of the unit (e.g. the control unit).

## Electrical Equipment Inspection

Regardless of the prescriptions of the property insurer / operator it is recommended to inspect the electrical equipment of the Flamcomat together with the heating or refrigerating installation at least every 1.5 years

(Also see **BS EN 60204-1:2006+A1:2009** and **BS 7671:2008**)

## Maintenance & Repair

These services may only be carried out when the system is shut down, or if the expansion automat is not required to balance the thermal expansion and contraction. The pressurisation equipment must be taken out of service and guarded against unintentional re-starting until the maintenance work is finished. Note that the safety circuits and data transmissions made while shutting down could trigger the safety chain or lead to false information transmitted to the Building Management System (BMS). Existing instructions for the heating or cooling unit as a whole must be observed. To stop hydraulic components, isolate the relevant sections and drain them using the available drain connections, and release the pressure.

Caution: The maximum system water temperature in conducting components (vessel, pumps, casings, hoses, pipelines, peripheral equipment) may reach 70°C and, in the case of improper operation, may exceed that. This brings a danger of burns and/or scalding.

The maximum pressure of system water in conducting components may equal the maximum set pressure for the applicable safety valve. Vessel, nominal pressure 2 bar, Safety valve max. 2 bar; pump-unit nominal pressure 6; 10 or 16 bar: Safety valve max 6, 10 or 16 bar. Use of eye/face protectors is required if the eyes or face could be injured by flying debris, parts or spraying fluids.

To stop electrical equipment (control unit, pumps, valves, peripheral equipment), isolate the power to the control unit. The power supply must remain off for the period of the work. It is forbidden to alter or use non-original components or replacement parts without written authorisation. Such acts may result in serious personal injury and endanger operational safety. They will also render any claim for damages against product liability null and void.

## Validity

All technical information, data and schematics contained herein are correct at the time of publication. This information is the sum of our current findings; we reserve the right to make technical changes subject to future development and product enhancement.

Images and schematics, therefore, may not represent assemblies or parts as delivered. Images, drawings and schematics are not to scale and may contain symbols for simplification.

## Copyright ©

This manual must be used confidentially; it may be circulated amongst authorised personnel only and must not be passed to third parties. All documentation is protected by copyright. Distribution, reproduction, extract, exploitation or notification of the contents is not permitted unless otherwise stated. Infringements are liable to prosecution and payment of compensation. We reserve the right to exercise all intellectual property rights.

## Operating Principle

The Flamcomat (PHP) is designed to accurately balance system pressure to within (typically) 0.2 barg.

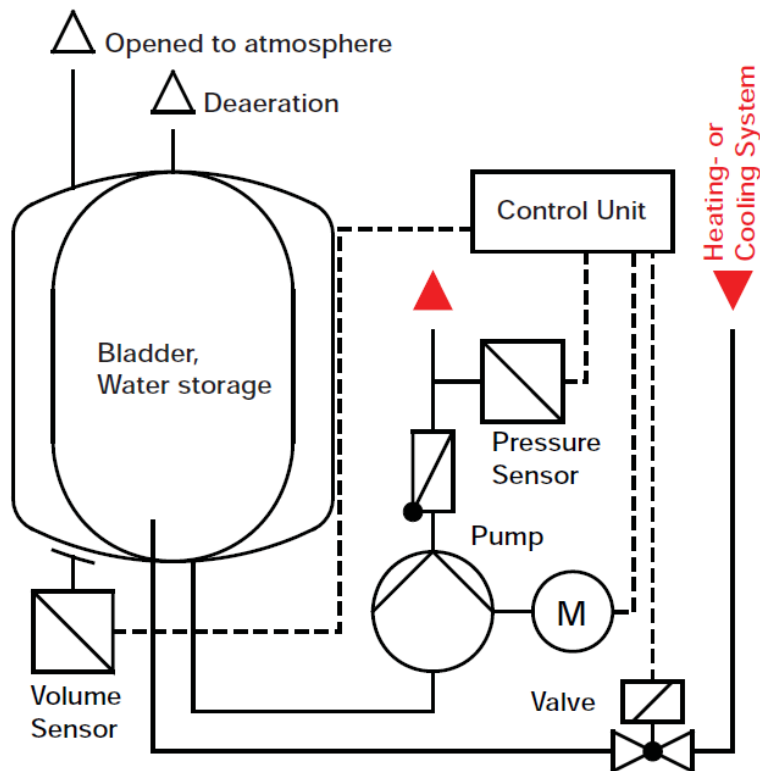

## Expansion Relief

As the system fluid heats up it expands, during expansion the system pressure attempts to rise. The Flamcomat (PHP) control equipment senses the pressure rise and opens the connection (solenoid) valve to the expansion vessel. The expanding fluid flows into the vessel, through an orifice (to restrict flow rates) and a system pressure rise is prevented.

## Contraction Compensation

As the system cools down, the system fluid contracts, during contraction the system pressure attempts to drop. The Flamcomat (PHP) control equipment senses the pressure drop and energises the pumps. The fluid is actively from the vessel back into the system, and a system pressure drop is prevented.

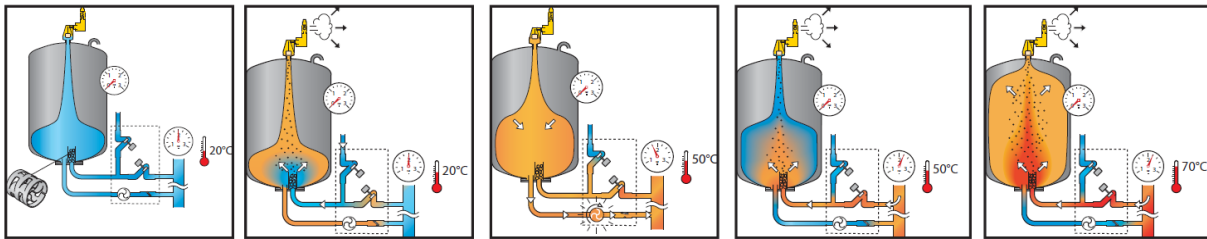

## Unit Safeguards

Weight sensor to calculate water content of vessel at any one time. The weight sensor is calibrated in the factory with the system dry, this allows for accurate water measurement during normal operation.

Pressure sensor for monitoring system pressure.

Filling interlock for replenishment fluid (via integral pressurisation unit). System fluid is lost through leaks and evaporation during air removal, fluid top up is required for maintaining the system content and integrity. This is automatically activated if the vessel volume drops below 12%.

Flamcomat (PHP) self diagnostics. The system holds the most recent alarm conditions in its memory, these can include water top up, excessive pump activation and high / low pressure alarms.

Cascade setting for the pumps allows the second pump to energise in addition to the first, if faster fluid replenishment is required.

## Pressureless Vessel and Active De-aeration

The water held in the vessel is at atmospheric pressure. The system effectively spills the expanded water into the Flamcomat (PHP) vessel. This action creates an active pressure drop between the system and the vessel.

In accordance with Henry's law dissolved air can be released from water by increasing the temperature or dropping the pressure.

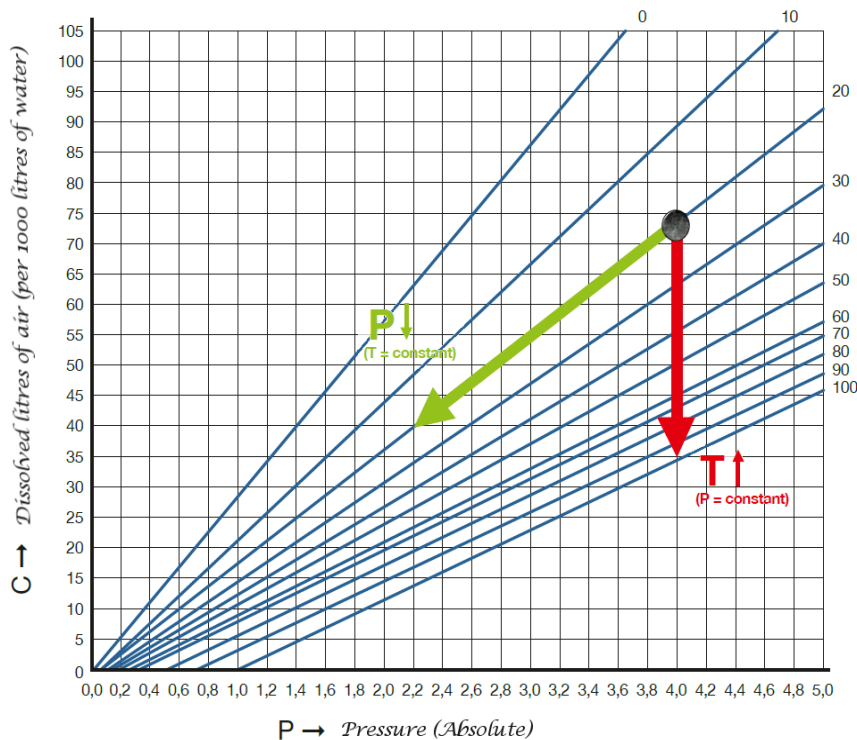

The Flamcomat (PHP) system with its pressure drop design allows dissolved air to be released from the system water. This is enhanced by a cartridge of patented PALL rings in the inlet stream to the vessel. The released air is allowed to vent out of the vessel via an automatic air vent on the top. The air vent is also fitted with a non return valve to prevent air being drawn back into the system.

When the Flamcomat (PHP) is in passive de-aeration mode air is released during the heating and cooling cycles only.

When the Flamcomat (PHP) is in turbo de-aeration mode the system water is continually being exchanged with the vessel water by cycling the solenoid and pumps on the skid. This turbo mode operates within the +/-0.2 bar tolerance on the system pressure setting.

**Note: Active De-aeration is not suitable and must not be activated on systems with flow temperatures exceeding 90°C.**

**Specification Details:**

Pump Set	Dimensions			Connections			Nominal Weight [kg]
	Width	Depth	Height	Vessel	System	Top-Up	
D0 (PHP C0)	680	680	1450	1-½"	1-½"	½"	105
D1 (PHP C1)	680	680	1450	1-½"	1-½"	½"	110
D2 (PHP C2)	680	680	1450	1-½"	1-½"	½"	115
D3 (PHP C3)	680	680	1450	1-½"	1-½"	½"	150
D4 (PHP C4)	680	680	1450	1-½"	1-½"	½"	215
D5 (PHP C5)	680	680	1450	1-½"	1-½"	½"	225
D6 (PHP C6)	680	680	1850	1-½"	1-½"	½"	240

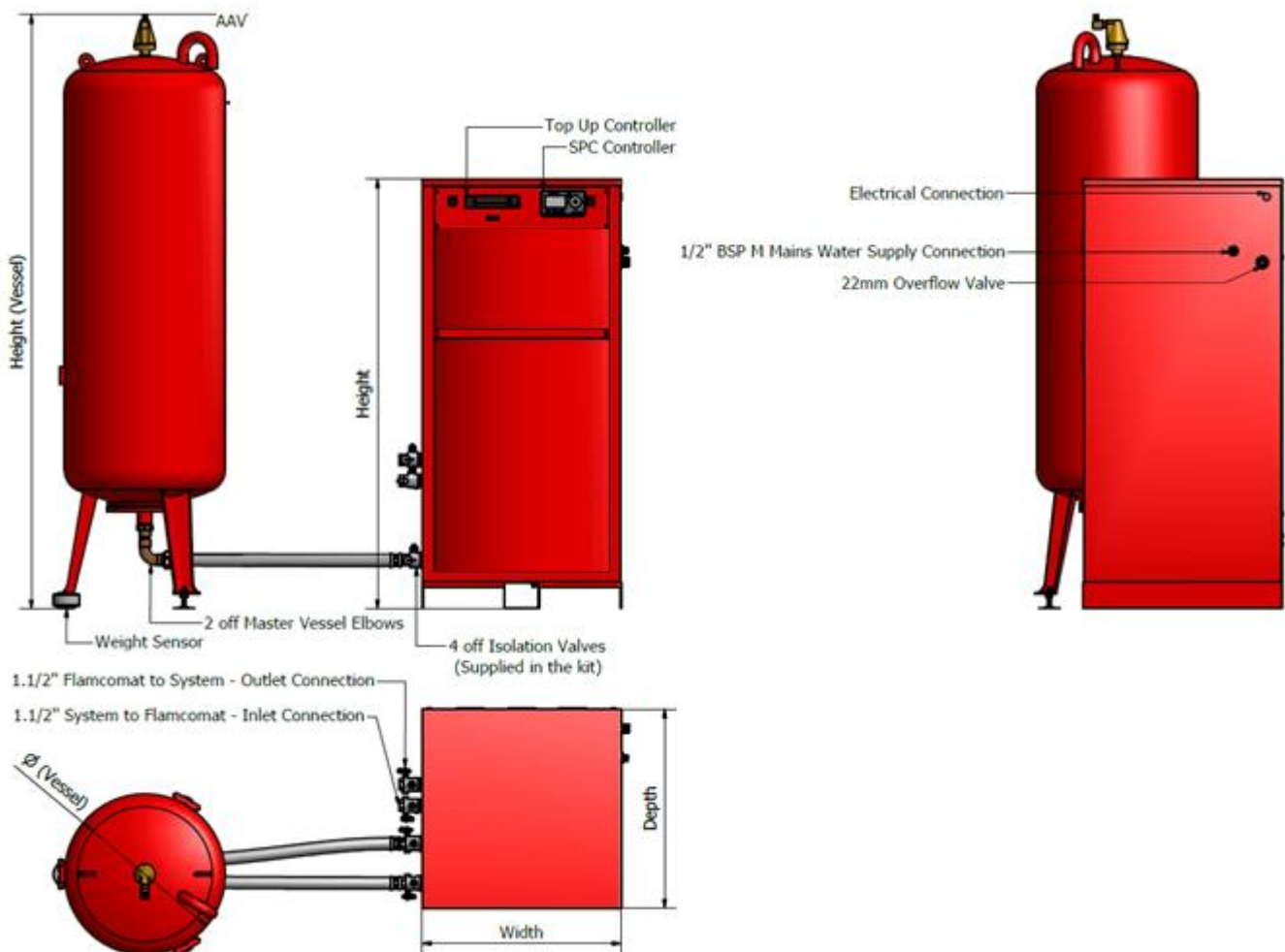

For vessel dimension see the main and auxiliary vessel list

Pump set	Noise Rating (dBA)	Pump Model	Full Load Current (Amps)	Power Consumption (kW)	Required Supply Voltage)
Top Up Equipment (Integral)	61	Pedrollo PQA60	2.1	0.37	230V/1/50Hz
D0 (PHP C0)	58	Grundfos CM1-4	6.2	1.0	230V/1/50Hz
D1 (PHP C1)	58	Grundfos CM3-6	8.8	1.34	230V/1/50Hz
D2 (PHP C2)	65	Grundfos CM5-6	10.6	2.6	415V/3/50Hz
D3 (PHP C3)	52	Grundfos CR3-15	14.8	2.2	230V/1/50Hz
D4 (PHP C4)	54	Grundfos CR3-17	6.4	3.0	415V/3/50Hz
D5 (PHP C5)	54	Grundfos CR3-23	9.0	4.4	415V/3/50Hz
D6 (PHP C6)	55	Grundfos CR3-31	12.6	6.0	415V/3/50Hz

### Installation & Placement:

The Flamcomat (PHP) should be installed in a frost-free and humidity free area. All vessels must be installed at the same height.

The GB (PHP M) main vessel must be connected using the flexible hoses to give an accurate weight reading from the foot sensor.

Additional BB (PHP A) auxiliary vessels can be connected using hard pipe. Individual isolation and drain valve for each vessel are recommended.

*Note: Many internal components of the Flamcomat pump set have been omitted*

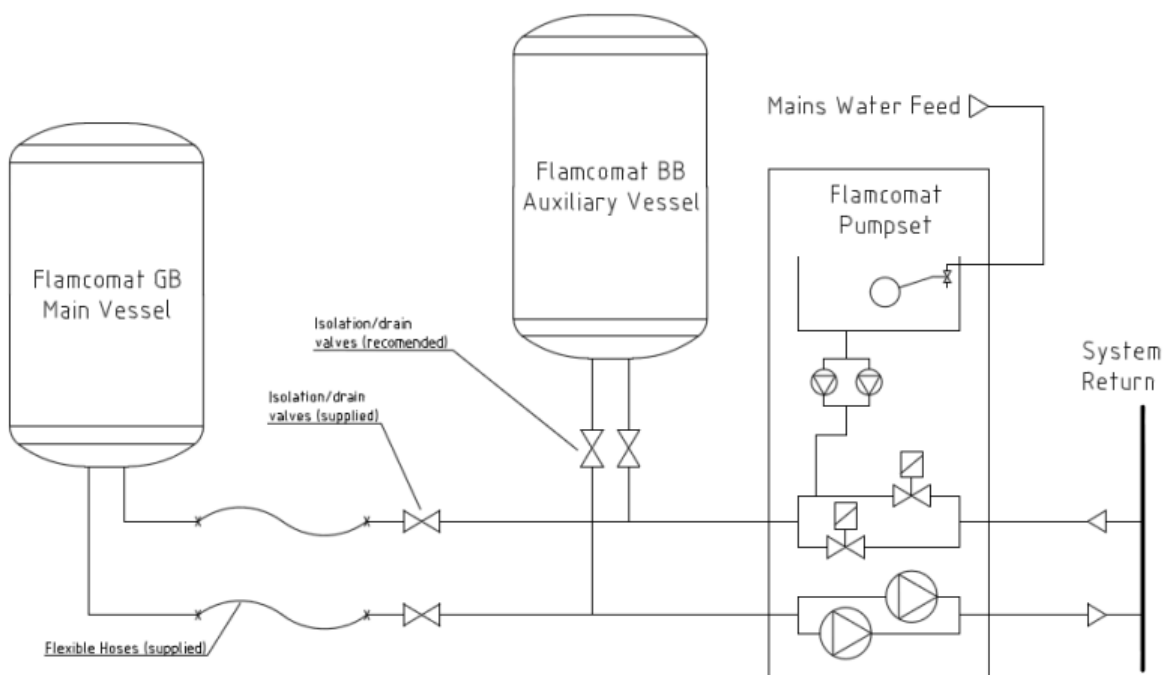

Typical Installation Diagram (illustration purposes only)

© 2014 Flamco group. All rights reserved.

We reserve the right to change designs and technical specifications of our products.



**Pump Curve:**

Curve designated with a prefix of 'M' show the normal characteristics of the pump module running as a single pump, curves with a prefix of 'D' show the normal characteristics of the pump module with 2 pumps running in duty assist mode.

For system requirements outside the shaded areas please contact your technical advisor.

**Please Note:**

The dimensions of the atmospheric expansion vessels are shown separately in this document. Flamcomat Pump set D0-D6 FLCs stating the figures for both pumps running at the same time. FLC for Top up unit shows figure for single pump running only as far as duty/standby mode is applicable.

Therefore the Flamcomat unit Final Full Load Current will be sum up of the Main Pump set current draw + Top up unit current draw.

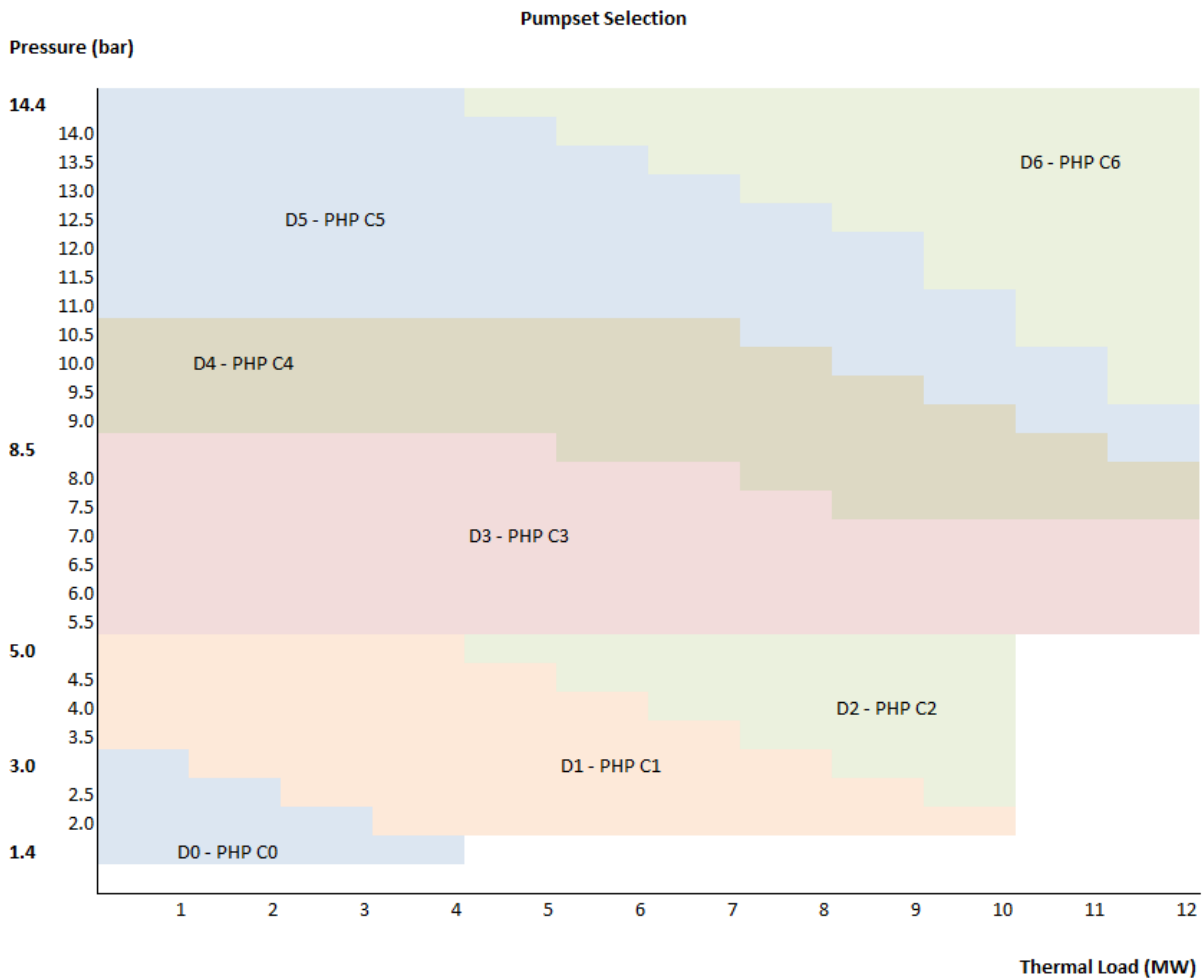

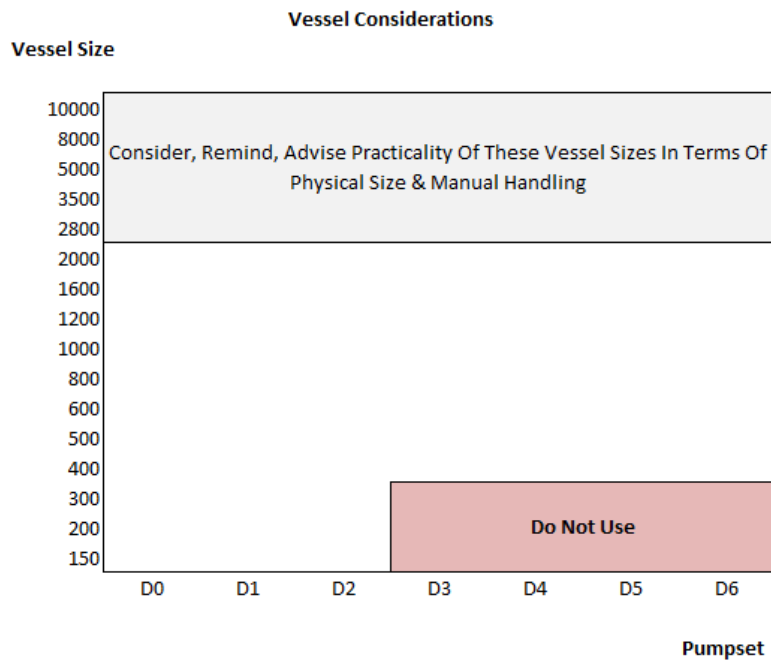

## Flamcomat (PHP) -Atmospheric expansion vessels

Flamcomat (PHP) main & Auxiliary vessel are manufactured to DIN 4807. The vessel includes a de-aeration cartridge containing Flamco patented Pall ring technology

**Flamcomat GB Main Vessels – PHP M Vessel**

Type	Capacity (l)	Dimensions		Dry Weight (Kg)
		Ø (mm)	Height (mm)	
GB 200 (PHP M2.0)	200	484	1560	31
GB 300 (PHP M3.0)	300	600	1596	41
GB 400 (PHP M4.0)	400	790	1437	62
GB 500 (PHP M5.0)	500	790	1587	70
GB 600 (PHP M6.0)	600	790	1737	77
GB 800 (PHP M8.0)	800	790	2144	92
GB 1000 (PHP M10.0)	1000	790	2493	106
GB 1200 (PHP M12.0)	1200	1000	2210	291
GB 1600 (PHP M16.0)	1600	1000	2710	346
GB 2000 (PHP M20.0)	2000	1200	2440	431
GB 2800 (PHP M28.0)	2800	1200	3040	516
GB 3500 (PHP M35.0)	3500	1200	3840	626
GB 5000 (PHP M50.0)	5000	1500	3570	1241
GB 6500 (PHP M65.0)	6500	1800	3500	1711
GB 8000 (PHP M80.0)	8000	1900	3650	1831
GB 10000 (PHP M100.0)	10000	2000	4050	2026

**Flamcomat BB Auxiliary Vessels – PHP A Vessel**

Type	Capacity (l)	Dimensions		Dry Weight (Kg)
		Ø (mm)	Height (mm)	
BB 200 (PHP A2.0)	200	484	1560	31
BB 300 (PHP A3.0)	300	600	1596	41
BB 400 (PHP A4.0)	400	790	1437	62
BB 500 (PHP A5.0)	500	790	1587	70
BB 600 (PHP A6.0)	600	790	1737	77
BB 800 (PHP A8.0)	800	790	2144	92
BB 1000 (PHP A10.0)	1000	790	2493	106
BB 1200 (PHP A12.0)	1200	1000	2210	291
BB 1600 (PHP A16.0)	1600	1000	2710	346
BB 2000 (PHP A20.0)	2000	1200	2440	431
BB 2800 (PHP A28.0)	2800	1200	3040	516
BB 3500 (PHP A35.0)	3500	1200	3840	626
BB 5000 (PHP A50.0)	5000	1500	3570	1241
BB 6500 (PHP A65.0)	6500	1800	3500	1711
BB 8000 (PHP A80.0)	8000	1900	3650	1831
BB 10000 (PHP A100.0)	10000	2000	4050	2026



**CE** Nr. 0045  
97/23/EC-PED

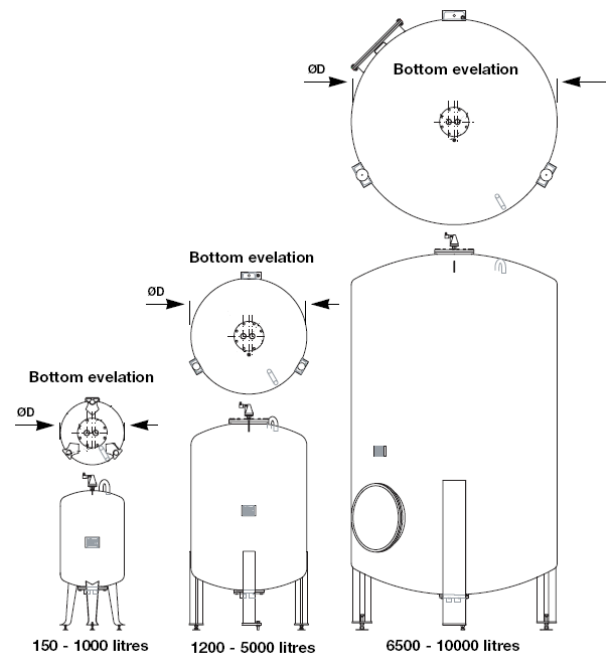

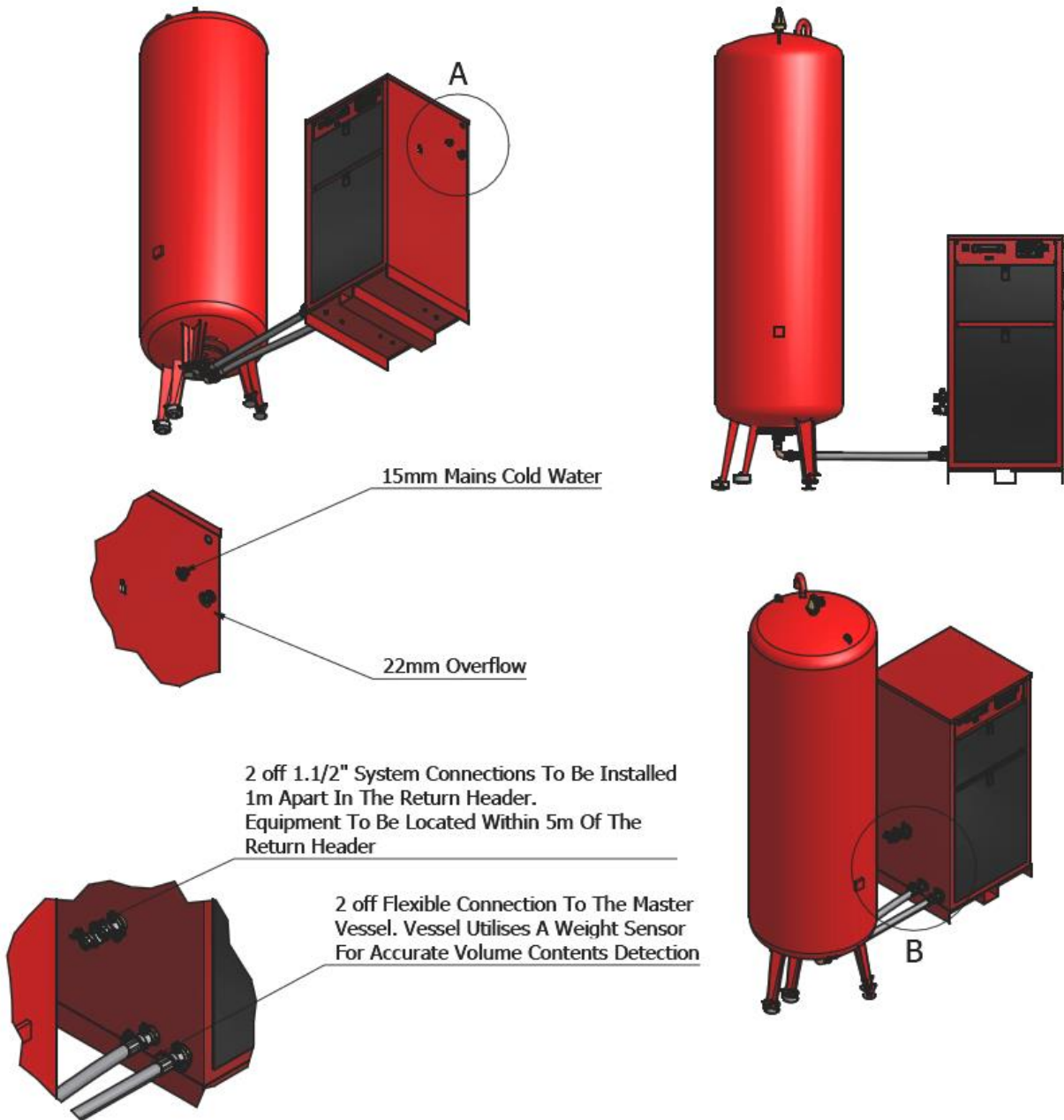
**Connection requirements:**

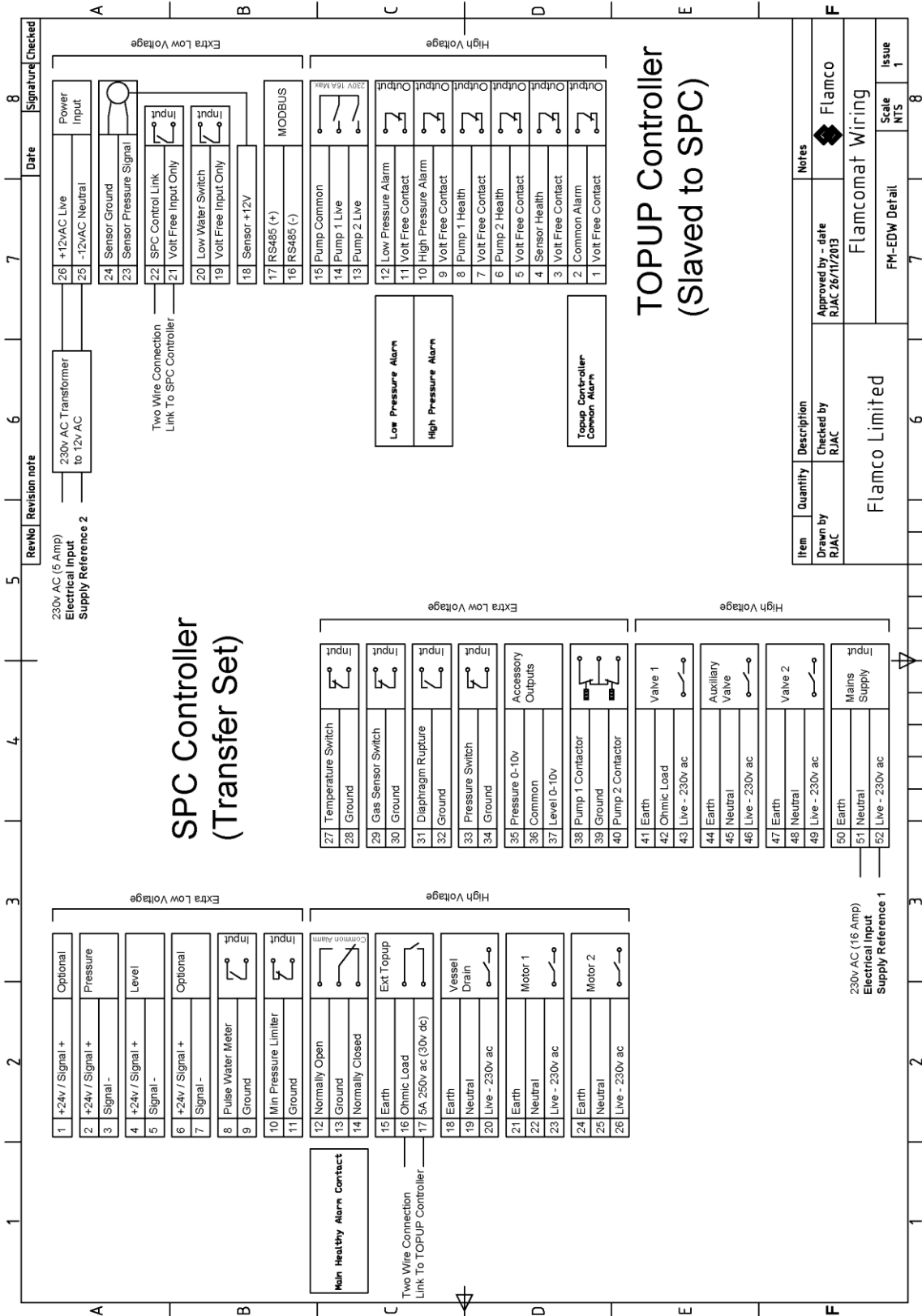

## SPC Wiring – 230v - Single Phase - 50 Hz (SPCx-lw)

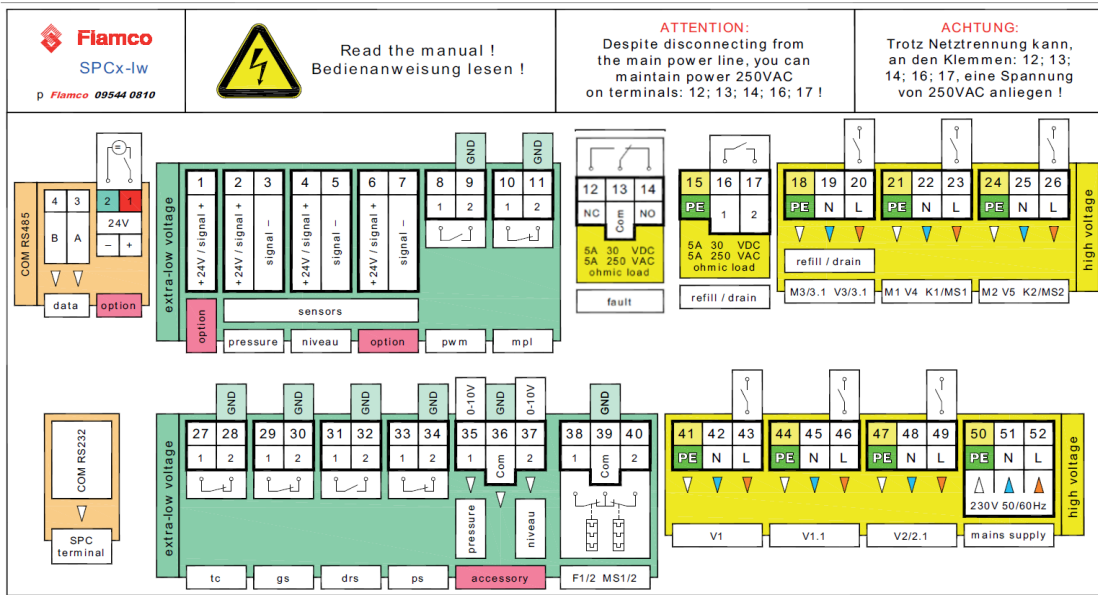

## SPC Wiring – 400v - Three Phase - 50 Hz (SPCx-hw)

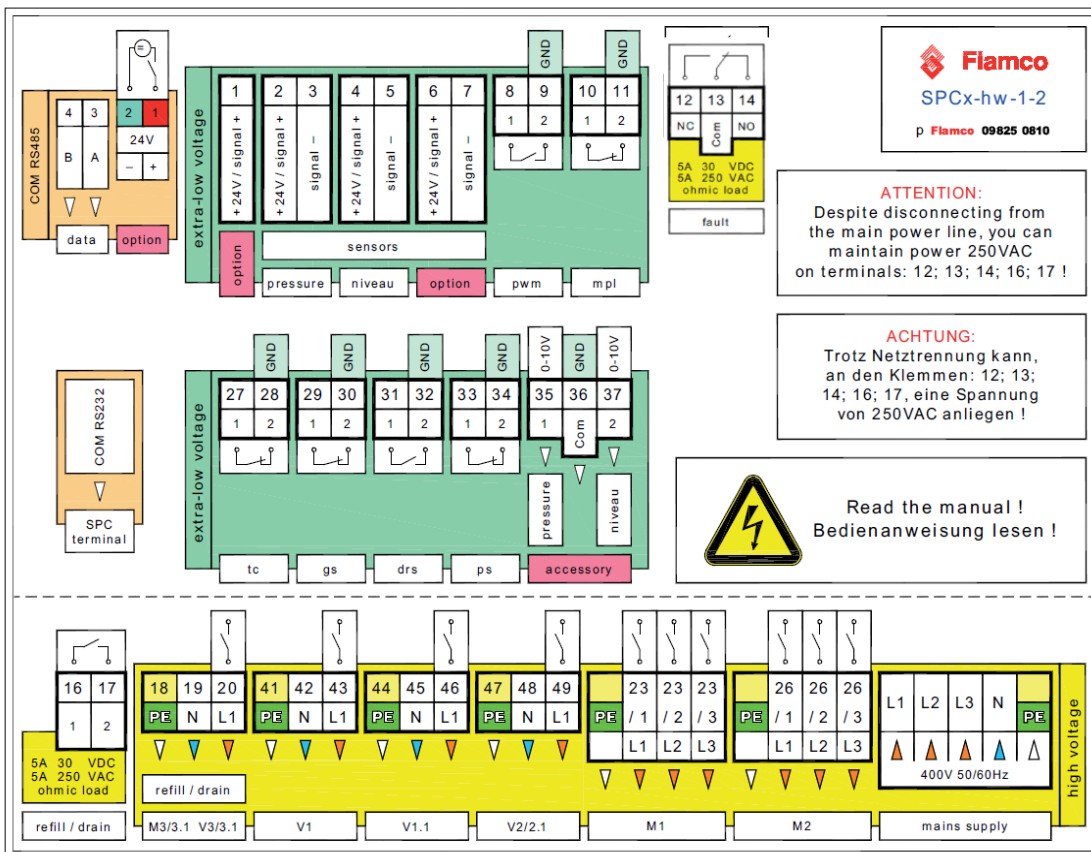



## SPC Terminal Plan Glossary

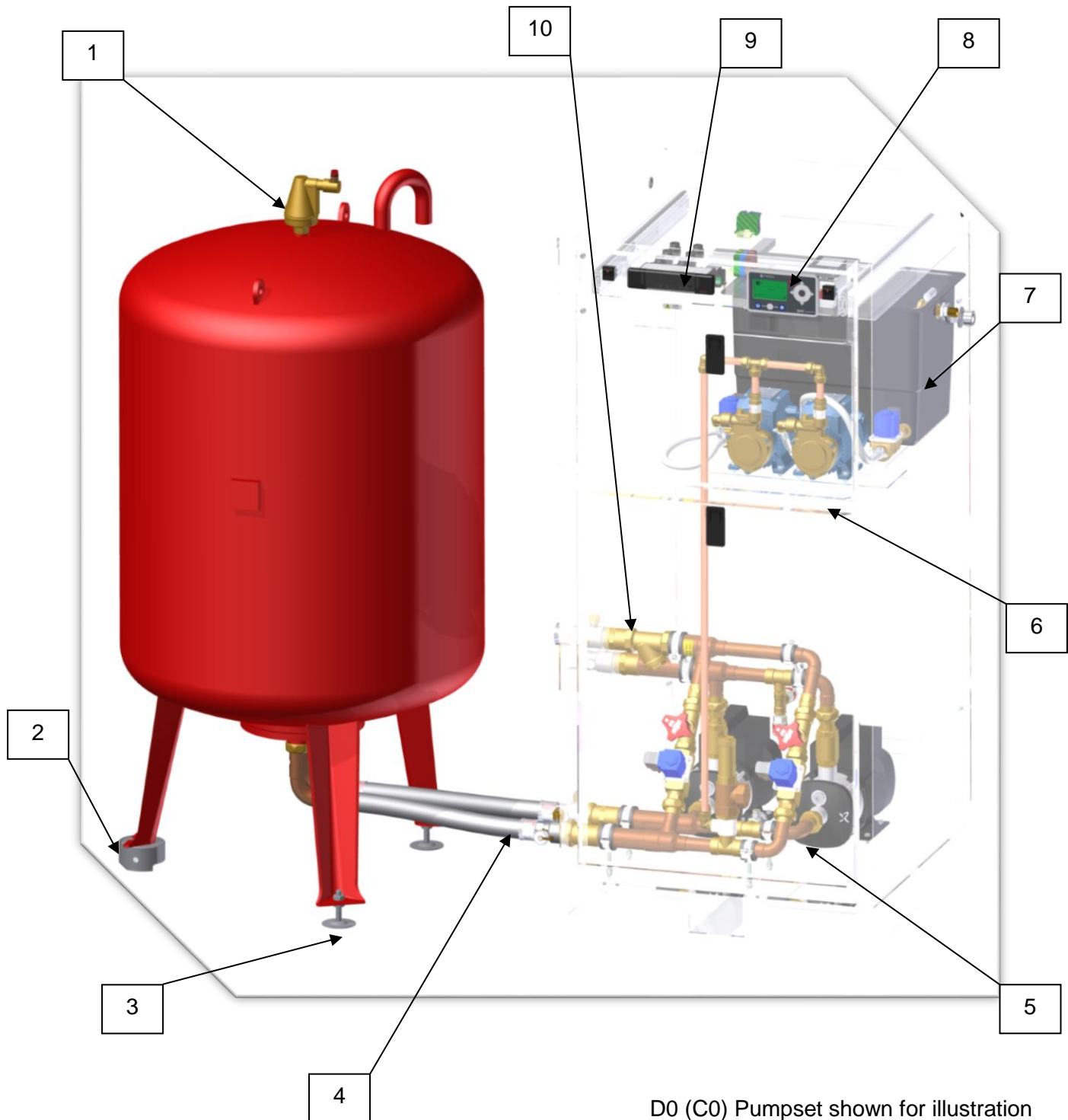

Accessory	Optional expansion connections for vessel volume and system pressure
COM 485	Serial communications port
Com	Common connection for volt free contacts
data	Optional data expansion connection
drs	Optional diaphragm rupture connection
extra low voltage	Protective low voltage $\approx$ 24v
fault	Common alarm volt free contact
F1/2 MS1/2	Motor circuit switch 1/2, combination motor circuit switch 1/2 (SPCx-hw)
gs	Optional vented gas sensor connection
high voltage	Voltage as per the markings on the Flamcomat
mains supply	Mains power feed
mpl	Optional minimum pressure limiter connection
M3/3.1 V3/3.1	Motor 3 (Optional top up) / 3.1 (Optional drainage valve) / Valve 3
M1 V4 K1/MS1	Motor 1 / Valve 4 (Optional) / Compressor 1 / Motor circuit combination 1
M2 V5 K2/MS2	Motor 2 / Valve 5 (Optional) / Compressor 2 / Motor circuit combination 2
niveau	Water level / vessel contents
ohmic load	Ohmic load / resistance
Option	Not available as standard
pressure	Pressure / System pressure
pwm	Optional Pulse Water Meter
ps	Optional Pressure switch / low level top-up switch
refill/drain	Optional top-up / drain
sensors	Sensors
tc	Optional Temperature switch
V1; 1.1	Valve 1; 1.1; Parallel expansion balancing valve
V2	Valve 2; expansion balancing valve
V2.1	Optional Valve 2.1

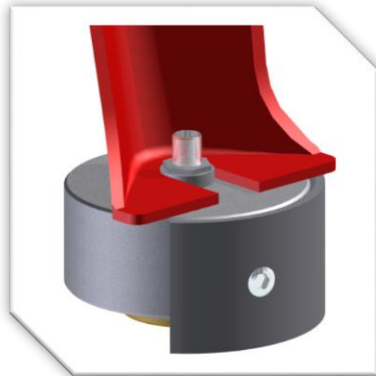

## Break down of parts



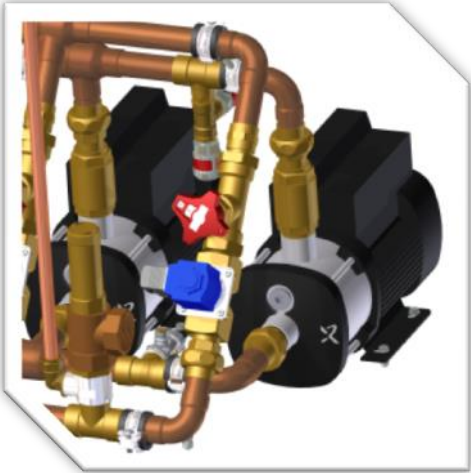

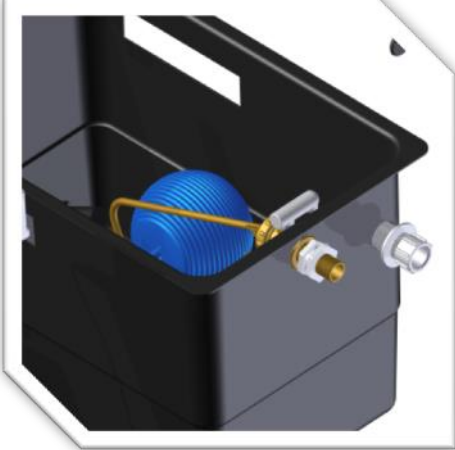
1		<p>Automatic air vent with non return valve</p> <p>Atmospheric Vent (Do not block or valve off)</p>
2		<p>Weight sensor cable connection</p> <p>Foot sensors (Weight / Load cell) <b>Please Do Not Throw Away</b></p> <p><b>Transport Guard, to be removed by the commissioning engineer only!</b></p>
3		<p>Jacking screw for levelling of the vessel. It is recommended that magnetic spirit levels are used to ensure the vessel is installed vertically</p>
4		<p>Flexible connection set. For main vessel(s) only.</p> <p>Elbow and swivel nut.</p> <p>Lock-shield valve complete with drain point, Flexible hose</p>

5		Non return valve Transfer pump Flow restrictor valve Expansion solenoid valve Safety relief valve (vessel protection only)
6		Non return valve Antigravity Solenoid Top-up pump
7		Top-up break tank complete with Fluid category 5 "AB" Air Gap (as per BS EN 13077:2008) WRAS approved float valve 22mm Overflow Fluid Category 4 "AF" Air Gap

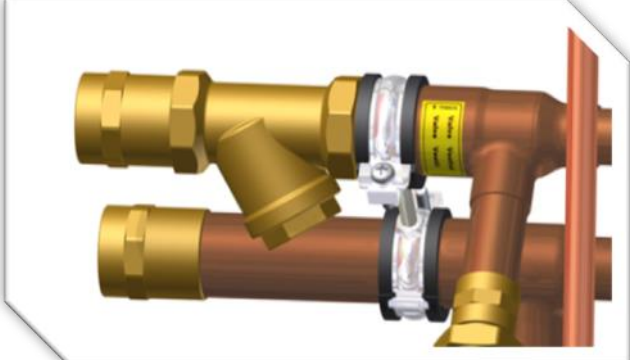
8		SPC front panel
9		Top-up controller (slaved to the SPC controller)
10		"Y" Strainer  System connections (1.25") Flow in to unit Flow out of unit

Note: Flamcomat vessel 200 -1000 L (2017 range have now change please see next page for more information about product change. Older vessel style need the older version of level sensor (FSI 1/FSI 2)

New level sensors have been introduced as the weight of the new vessels has decreased. These sensors are installed on an extension, are delivered separately and will need to be installed onsite. These sensors are not backwards compatible. As the new vessels have less weight, during installation the controller needs to be setup for A type (STAG) or B type (Bunschoten) vessel. All new vessels are clearly marked A type or B type on the product label.

## Flamcomat spare list

### Location of parts

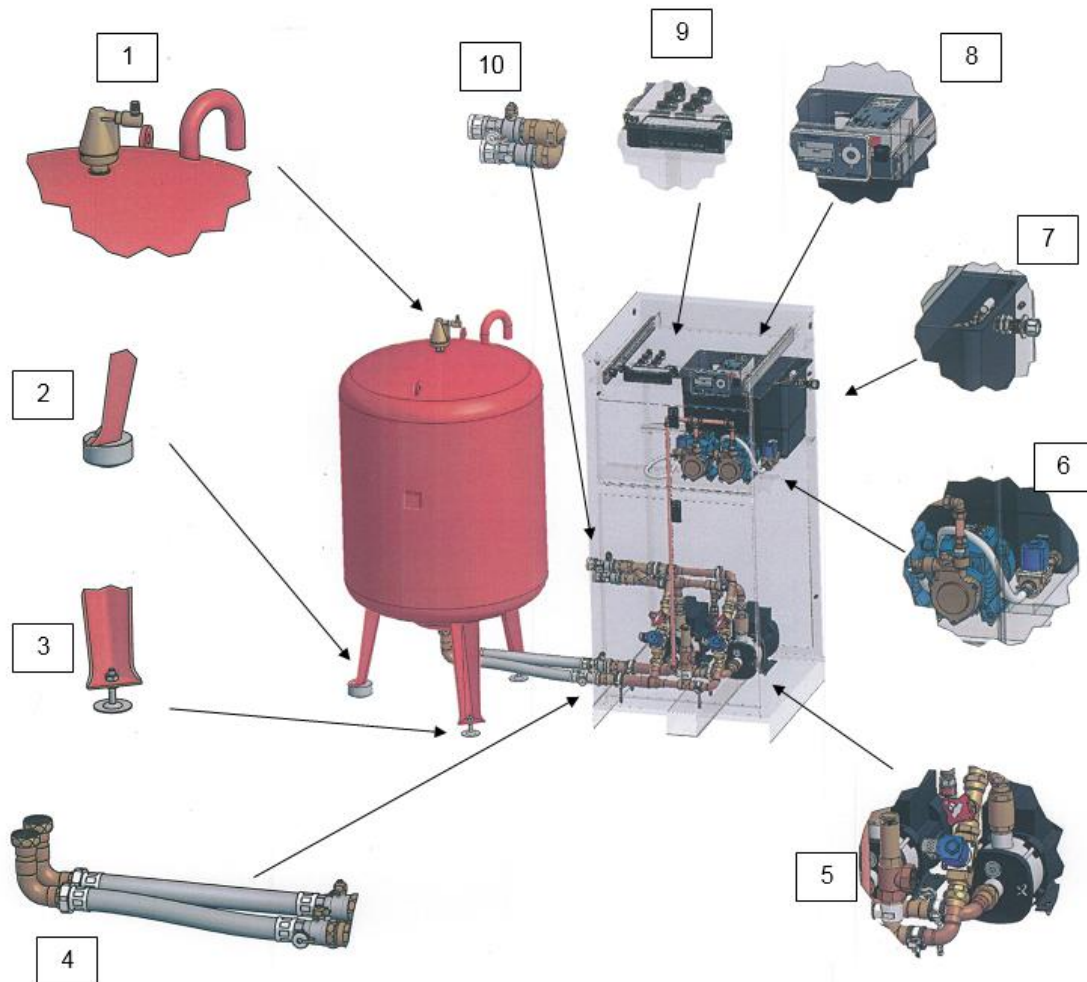

D0 Pumpset shown for illustration

1. Automatic air vent assembly
2. Weight sensor
3. Jack screw for vessel x 3 (>1200 l)
4. Flexible hose kit
5. Transfer pump set arrangement
6. Top up pump set arrangement
7. Break tank assembly
8. SPC Controller / Terminal box
9. Micro controller (Top up controller)
10. System connection (Locksheild valve)

## Spare Parts List

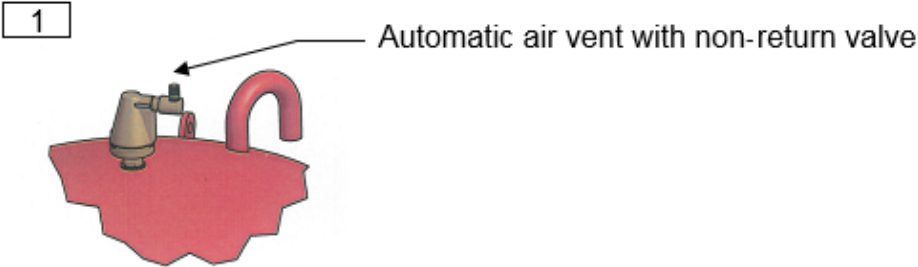

Kit No	Kit Description	Part Description	Qty
STA12539	Flamcomat - Automatic Air Vent assembly kit	Flexvent Super 1/2 Auto Air Vent	1
		Single check Valve	1
		Gauze	1
		22 mm x 1/2 F Coupling	1
		15 mm x 1/2 C X MI Coupling	1

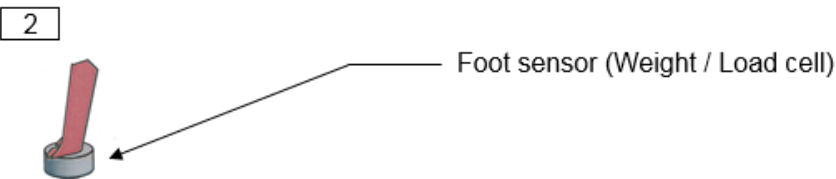

Description	Part code
Level sensor FSI 1 (150 - 300l) <2017	STA07415
Level sensor FSI 2 (400 - 800l) <2017	STA07416
Level Sensor FSI 3 (1000l - 2000l) <2017 (up to 1000L)	STA07417
Level sensor FSI 4 (2800 - 3500l)	STA07418
Level sensor FSI 5 (5000 - 10000l)	STA07419

FS1 / FS2 / FS3 version above are up to 2017 after 2017 please see number 3 for details

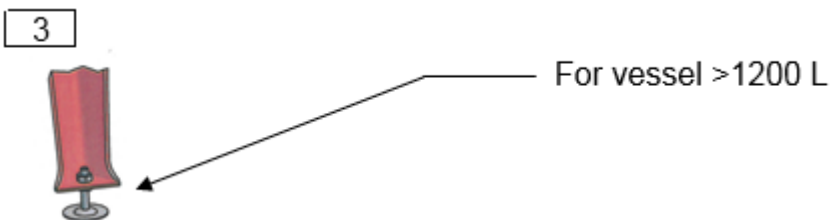

These are standard issue with vessel >1200L

**Flamcomat vessel – 2017 Onwards (Up to 1000 L)**

Vessel size (L)	Bladder	Extension piece >P<	Level sensor >Q<	Adjusting foot >R<
200	STA10017	STA10039	STA10036	STA10033
300	STA10018			
400	STA10019	STA10030	STA10037	STA10035
500	STA10020			
600				
800	STA10021		STA10038	
1000	STA10022			

Every number corresponds with 1 item only.

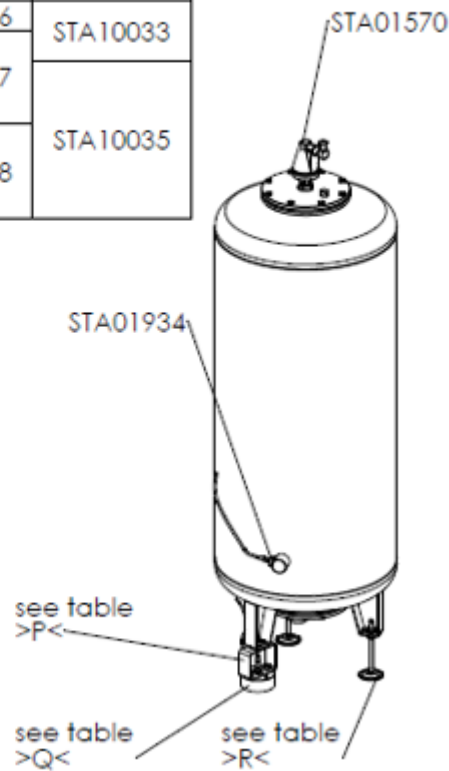

Description	Part code
Level sensor FSI B1 (200l) >2017	STA10036
Level sensor FSI B2 (300l - 500l) >2017	STA10037
Level Sensor FSI B3 (600l - 1000l) >2017	STA10038
Weight sensor connector - Flamcomat	STA10043
Diaphragm Rupture Sensor 200l - 1000l FMAT >2017	STA01934
Flexvent super 1/2" with air intake preventor	STA01570
Diaphragm 200l >2017	STA10017
Diaphragm 300l >2017	STA10018
Diaphragm 400l >2017	STA10019
Diaphragm 500l - 600l >2017	STA10020
Diaphragm 800l >2017	STA10021
Diaphragm 1000l >2017	STA10022
Extension piece for level sensor M12 [200l - 300l]	STA10039
Extension piece for level sensor M16 [400l - 1000l]	STA10030
Adjusting foot M12 [200l - 300l]	STA10033
Adjusting foot M16 [400l - 1000l]	STA10035

4

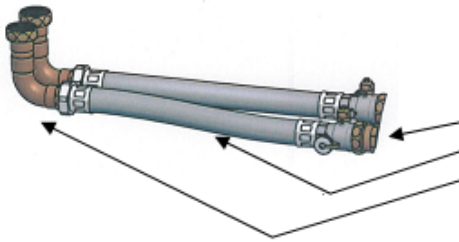

Flexible connection set. For main vessel(s) only.  
 Lockshield valve complete with drain point,  
 Flexible hose  
 Elbow and swivel nut.

Description	Part code
Vessel connection Type 4	17730
Vessel connection Type 5	17731

5

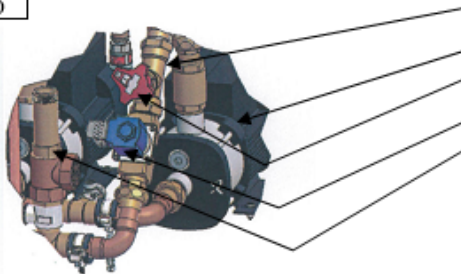

Non- return valve (Transfer pump)  
 Transfer pump  
 Flow restrictor valve  
 Expansion solenoid valve  
 Safety relief valve (vessel protection only)

Kit No	Kit Description	Part Description	Qty
STA12540	Flamcomat - Expansion Solenoid Kit D0 - D3	SPC Solenoid Valve - Danfoss 1"	2
		Solenoid Coil	2
		Solenoid Plug	2

Kit No	Kit Description	Part Description	Qty
STA12541	Flamcomat - Expansion Solenoid Kit D4 - D6	SPC Solenoid Valve - Danfoss 1/2"	2
		Solenoid Coil	2
		Solenoid Plug	2

Description	Part code
<b>Non-return valve</b>	
Non- Return Valve (Check Valve) 1" (D0, D1, D2)	STA01922
Non- Return Valve (Check Valve) 1/2" (D4, D5, D6)	STA06636
Flat Non- Return Valve D3 to D6	STA02037
<b>Safety relief valve</b>	
1-1/4" 2 bar Safety relief valve D3 - D6	STA09675
1" 2 bar Safety relief valve D0 - D2	STA06288

Description	Part code
<b>Transfer pump</b>	
Pump D0 CM 1-4 A-R-I-E AQQE CAAN (1 x 230V)	STA06824
Pump D1 CM3-6 A-R-I-E AQQE CAAN (1 x 230V)	STA06825
Pump D2 CM5-6 A-R-I-E AQQE (3 x 415V)	STA06827
Pump D3 CR3-15 A-FGJ A-E HQQE (1 x 230V)	STA06828
Pump D4 CR3-17 A-FGJ-A-E HQQE (3 x 415V)	STA06704
Pump D5 CR3-23 A-FGJ-A-E HQQE (3 x 415V)	STA06829
Pump D6 CR3-31 A-FGJ-A-E HQQE (3 x 415V)	STA06830

6

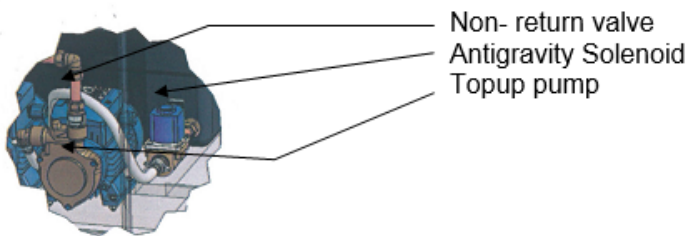

Kit No	Kit Description	Part Description	Qty
STA12542	Flamcomat - Topup pump & Solenoid Kit	Pump – Pedrollo PQA60	2
		Single check Valve (Non-return valve)	2
		Antigravity Solenoid Valve	2
		Solenoid Coil	2
		Solenoid Plug	2

7

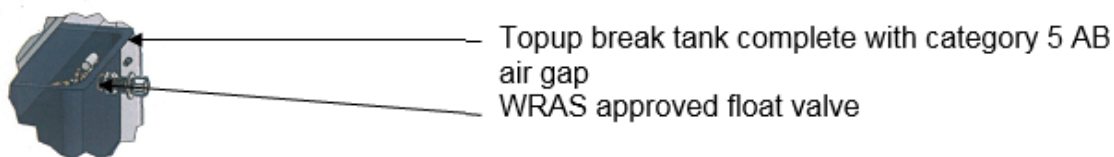

Kit No	Kit Description	Part Description	Qty
STA12530	Break Tank Spares	Low Level Float Switch	1
		Float Valve	1
		15mm x 1/2 Tank Connector	2
		1/2 Pillar Washer	2
		1/2 Flat Gauze Filter	2
		Overflow Connection	1



8

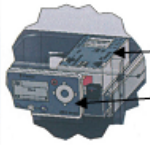

SPC controller main terminal box  
SPC controller panel

Description	Part code
<b>SPC Controller</b>	
SPC Controller 230v D0, D1, D2, D3, D4, D5, D6	STA06018
<b>Terminal box</b>	
Motor Contactors for D2 (3 Phase) (2 x 1.3 kW)	STA06851
Motor Contactors for D4 (3 Phase) (2 x 1.5 kW)	STA06819
Motor Contactors for D5 (3 Phase) (2 x 2.2 kW)	STA06821
Motor Contactors for D6 (3 Phase) (2 x 3.0 kW)	STA06823

9



Topup controller

Kit No	Kit Description	Part Description	Qty
STA12500	Controller Spares Kit	Micro Controller	1
		On/Off Switch	1
		Electrical Plate - Two pump	1

10



System connection lockshield valve

Description	Part code
Ball Connection Valve & Adaptor DN32	17738

**Not shown items:**

Description	Part code
<b>Pressure Sensor</b>	
Topup Pressure Sensor 10b (1-6V) 060G3996	STA12543
Topup Pressure Sensor 16b (1-6V)	STA12544
JUMO MIDAS 0-20 mA 0-16 Bar (Transfer pump sensor)	STA06286
<b>Strainer (outlet)</b>	
Particle Filter D0, D1, D2, D3	STA01559
Particle Filter D4, D5, D6	STA01560
<b>Balancing Valve</b>	
BALANCING VALVE - IMI STAD DN15 (D0 - D3)	STA07510
BALANCING VALVE - IMI STAD DN25 (D4 - D6)	STA09332



Transducer 0-10 Bar (1-6V)



Transducer 0-16 Bar (1-6V)



Particle Filter

 Jumo Midas 0-20mA  
(Transfer pump transducer)

Balancing Valve DN15

**Accessories:**
**Auxiliary vessel connection**

Connection set including T-piece PN10, hose and a block & bleed valve for easy installation of a Flamcomat FB auxiliary vessel.



Description	Part code
Auxiliary vessel connection Flamcomat	17647

**T-Piece**

T-piece PN 10 for an easy installation of a Flamcomat FB auxiliary vessel.

Description	Part code
T-Piece G 1-½"	17664

**Pressure Safety Switch**

Description	Part code
Minimum pressure switch	27459
Maximum pressure switch	27458

**Bimetallic Temperature Switch**

Electromechanical switch with fixed switching temperature of 70 °C.

Flamcomat: Reaching 70 °C is detected as an error and is stored in the error memory. When this temperature is reached the temperature, switch prevents the system from degassing until the temperature falls below 70 °C again.

Description	Part code
Bimetallic Temperature Switch	17659



### Diaphragm Rupture sensor

To be fitted to Flamcomat main vessel to monitor vessel's diaphragm. Can be integrated later date. Used on > 1200L



Description	Part code
Diaphragm rupture sensor	22386

### Analogue Signalling

For analogue signalling (0-10 V) of vessel volume (0-100%) and system pressure (0-16 bar).

- Build-in afterwards is possible.



Description	Part code
Analogue Signalling	17802

### SD Card Module

External SD Card module used for:

- Saving of SPC parameter files.
- Downloading of files via SD Card to PC.
- Transmission of the files to Service Centre.
- Firmware updates by the service support.



Description	Part code
SD Card Module	17803

### SPC Extension Module

Connection module for communication between two controls.

- For SPC control.
- Makes linked operating options possible (Configuration and Commissioning by Flamco Service Only).

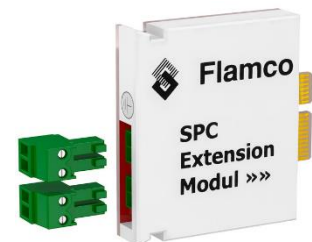

Description	Part code
SPC Extension Module Master + Slave	17500
Extra Slave Module	17501

## Installation Checks & Tasks

- Remove the appropriate coverings.
- Prior to installing the vessels, ensure the weight sensor cover plate is in place. Do not remove the cover plate; **this task must be left for the commissioning engineer.**
- If the cover plate has been removed prior to installing/standing the vessel in position, extreme care must be taken to prevent impact damage to the weight sensor.
- Vessels must be installed vertically, use of magnetic spirit levels is recommended.
- Vessels must be free standing and not bolted down to the ground.
- Vessels must be connected using the provided flexible hoses to allow the foot sensor to work correctly
- Vessels must not have electrical trunking, pipe work or cable trays attached or resting upon or against them; this will interfere with the weight reading on the vessel and disrupt normal operation.
- Vessels must be installed on the same level as the pumpset unit.
- Multiple vessels must be installed at the same level
- Multiple vessels must have the same volume, e.g. 2 x 600 litre vessels is acceptable 2 x 300 + 1 x 600 is not acceptable
- Ensure that the float valve within the top-up break tank is set to its lowest position.
- All pipe-work connections are to be made with appropriate proprietary jointing compound. **PTFE is not permitted.**
- Connect the overflow pipe-work.
- Connect the mains water pipe-work.
- Connect the system pipe-work, the system connections must be 1m apart and both connections are to be on the return header to the boiler. Water entering the Flamcomat (PHP) **must be below 70 °C**, if the temperature at the point of connection is greater than 70 °C then appropriate measures must be taken to reduce the temperature before it enters the Flamcomat (PHP). An intermediate vessel(s) is typically used for this purpose.
- When multiple intermediate vessels are supplied, they must be piped in series, with the hotter water connected to the top of the vessel, cooler water from the bottom of the vessel is then taken to the top of the next intermediate vessel. Cool water from the bottom of the last intermediate vessel is then taken and connected to the pumpset.
- The Flamcomat pumpset (PHP) is typically sited within 5m of the connection points to the return header. The pipe-work diameter must not be reduced over this distance.
- The Flamcomat vessels (PHP) are also typically located within 5m of the Flamcomat pumpset; the master vessel must be freestanding and connected using the flexible hoses provided. The pipe-work diameter **must not** be reduced over this distance.
- When using multiple Flamcomat (PHP) vessels the additional vessels, without the foot sensor, can be hard piped. The pipe-work diameter must not be reduced and the additional vessels must be within 5m of the pumpset.
- If the pumpset or vessels are installed at distances over 5m and under 15m the equipment may operate correctly by increasing the pipe-work diameter to 50mm (2"). It may also be required in this case to move the pressure sensor from the pumpset and install the sensor directly in the return header. A 15mm (1/2") connection in the header would be required in this case.
- Installation distances over 15m are not recommended.
- Check the break tank internal pump suction filter is present and clear.
- Connect the electrical supply to the fused connection block / fused spur as appropriate.
- Connect the boiler to the boiler interlock connection / Common Alarm if required.

## Flamcomat (PHP) Checklist

Connected to the return header? Confirm Y/N

Connected temperature less than 70 deg. C? Confirm Y/N

If temperature at point of connection is above 70deg. C

Is there VSV Intermediate vessel present? Confirm Y/N

If there is a VSV Intermediate vessel present is the hotter system  
side connected to the top

Confirm Y/N

Is the floor surface where GB Master (PHP M) vessel is laid down smooth,  
without holes or dents (consistent surface)? Confirm Y/N

Is the transportation lock present at one of the Master vessel legs? Confirm Y/N

Verify the distance in between Flamcomat and System Return Header? Confirm Y/N

Distance from the return header	Up to 5 meters	Between 5 meters and 10 meters	Over 10 meters but below 25 meters
Required pipe diameter	1.1/2" minimum	1.1/2" minimum	2" minimum
Recommend sensor move to the header?	No	Yes	Yes

**NOTE:** Interconnecting pipes from Flamcomat (PHP) to system return header shall be installed to ensure a minimum pressure drop through the pipes (as few elbows as possible).

Inlet and outlet connections are on the return header 1000mm apart? Confirm Y/N

Is Flamcomat cabinet and associated vessel(s) laid at the same floor plane? Confirm Y/N

Master vessel (GB vessel) free to move and fit via flexible hoses (supplied in kit)?	Confirm Y/N
Is the GB Master vessel installed in almost perfect vertical position	Confirm Y/N
Is the AAV complete with the Intake Preventer installed at the top of (each) vessel?	Confirm Y/N
Flow restrictors set to match the system requirements?	Confirm Y/N
Top-up equipment checked as operational?	Confirm Y/N
Pump and valve timers set and checked as 5 seconds?	Confirm Y/N
Main transfer pumps bled?	Confirm Y/N
Topup pumps bled?	Confirm Y/N
All valves open between the system and the unit?	Confirm Y/N
No non return valves are present between the system and the unit?	Confirm Y/N
Is the unit connected to the main system in the orientation below?	Confirm Y/N

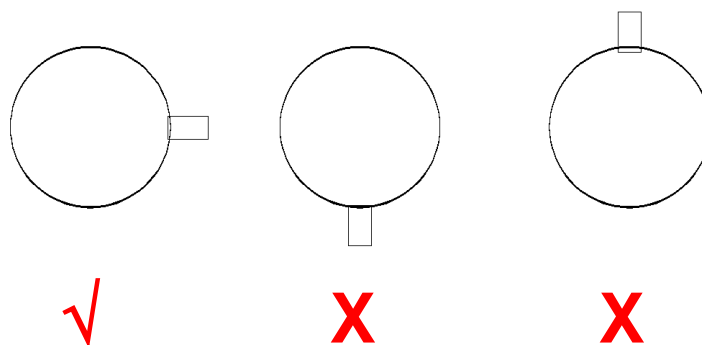

## Commissioning Against a Running System

Commissioning can only be guaranteed and recognised when performed in conjunction with an operational heat exchanger. Standard practice involves setting up the Flamcomat (PHP) with the heat exchanger disabled, and then operation is confirmed with the heat exchanger activated.

If a different volume level is required than the self-established minimum level after start (operational system), the vessel should be filled according to the minimum required level needed for the actual system temperature, after completing the commissioning procedure on the control unit.

The graphs below are provided for guidance only, individual systems may require interpretation to achieve the desired results.

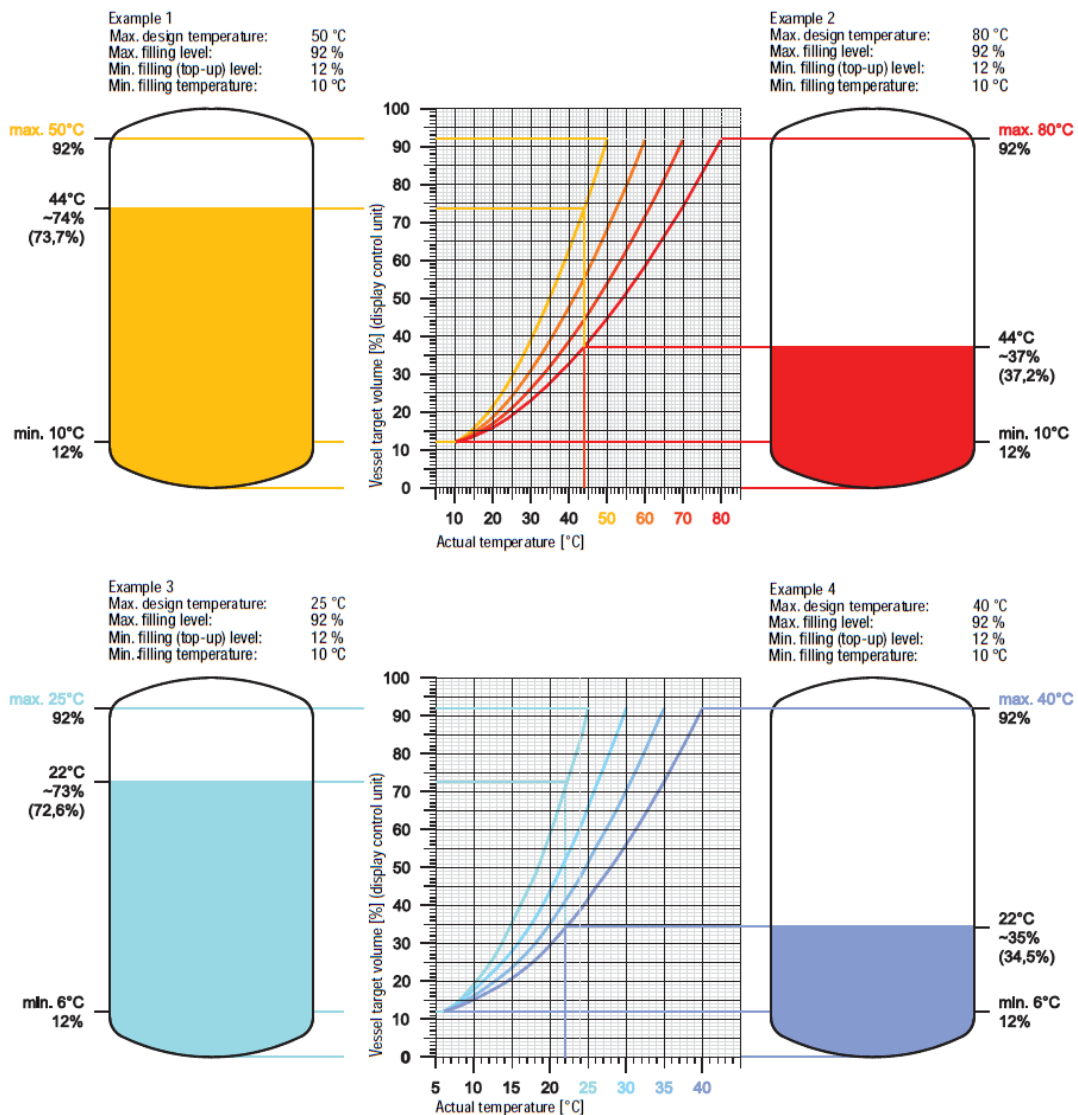



## Initial Commissioning

- Document the commissioning procedure (actions and settings).
- Check that all the installation and other actions prior to use have been carried out in full (e.g. power supply available and connected, functioning or active fuses, seal tightness of the equipment, removed transport securing of the volume sensor).
- Caution: Ensure that the basic vessel is not filled until all the commissioning measures have been completed.
- Adjust the flow restrictor valve on the pump module, remove the centre plastic cover (beige plastic) to reveal the limiting 'grub' screw

### Flow Restrictor Setting

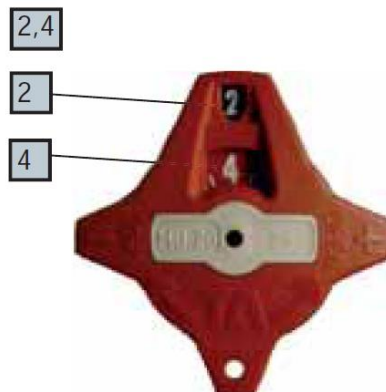
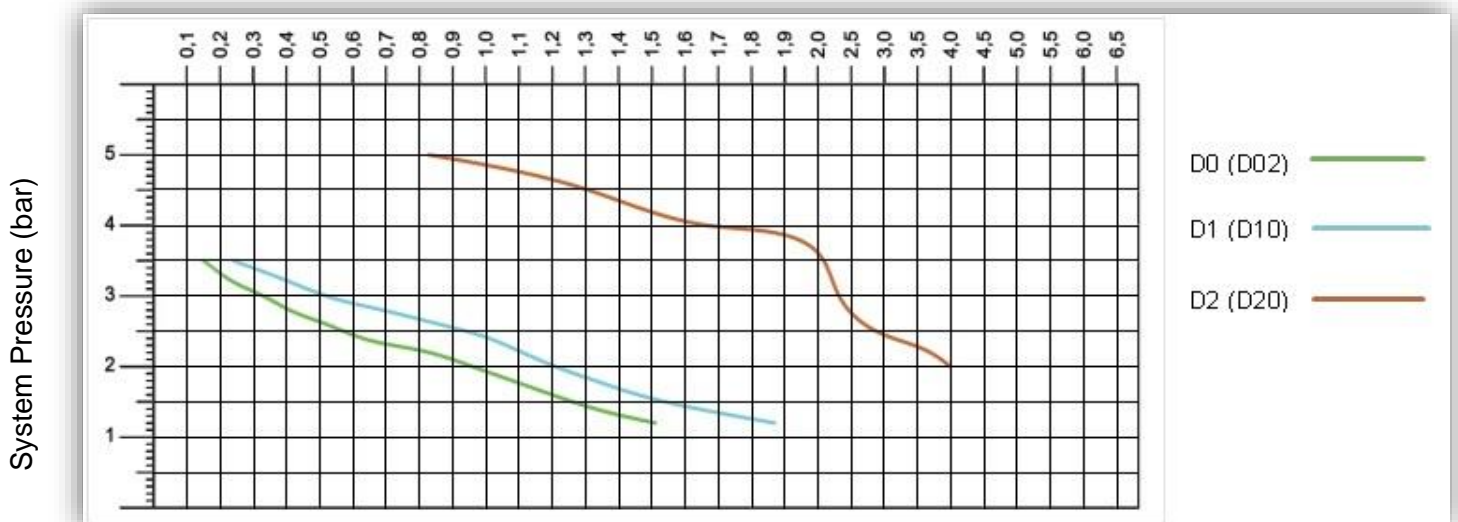

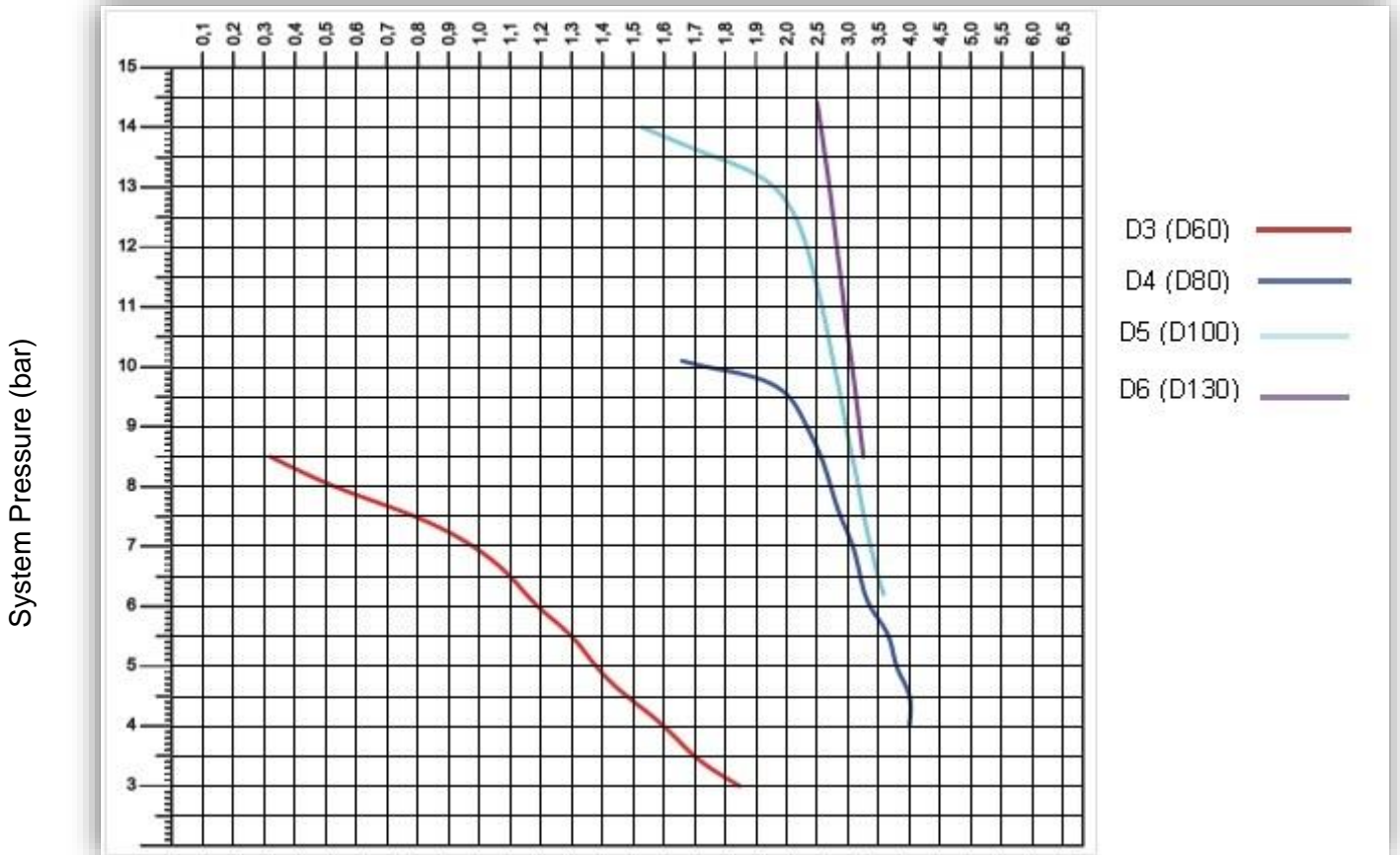





- Fill and vent the heating or cooling system (not the vessel!)
- Check the operational readiness of the top-up equipment
- Open the lock shield valves at the flexible connection assembly (vessel connections)
- Switch ON the control unit and run the start menu procedure
- This start-up procedure is followed by switching ON the top-up. Until a volume level of approx. 7% is reached (see display), turn the control unit OFF and de-aerate pump or pumps. In the case of pumps with automatic vents these should be to opened by a single turn of the red cap.
- Open the lock shield valves on the system side of the Pumpset.
- Seal all the lock shield valves (open position).
- Read through the manual for any and all recommendations and checks, perform actions as required
- **SWITCH ON THE CONTROL UNIT**

## SPC Controller Set-up



The SPC Controller is a Touch sensitive multifunction Controller

	<b>Warning Indiciation</b>
	<b>Backup</b>
	<b>Edit</b>
	<b>Select</b>
	<b>Navigation Wheel</b>

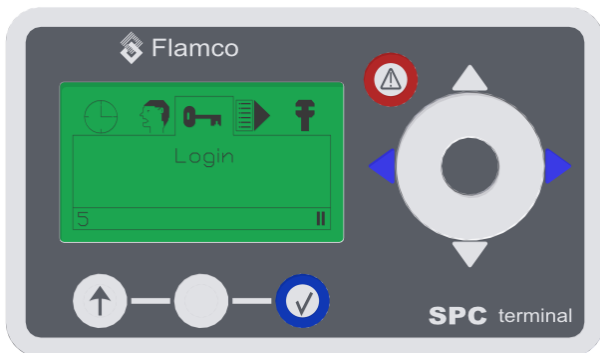

Scroll to Start menu Symbol and press select

The menu (below) will be shown, you have to set up in order the unit will not allow you to move on until each selection has been confirmed.

First option is a Prompt to read the Manual (9-1),  Press "Select"

### System Safety Valve

Nom. Pressure (Nominal pressure) (9-4)  Press "Select"

Scroll to Edit (9-4-1) and press "Select" you will be given the following menu -

Using the Edit and Select buttons change to appropriate level the Select and confirm.



Factory Operating Calibration (9-6)  press select an hour glass will briefly appear and if vessel is empty and correct vessel has been selected then a tick will appear on screen to confirm.

Pressure setting (9-8)  press select you will have a screen below.

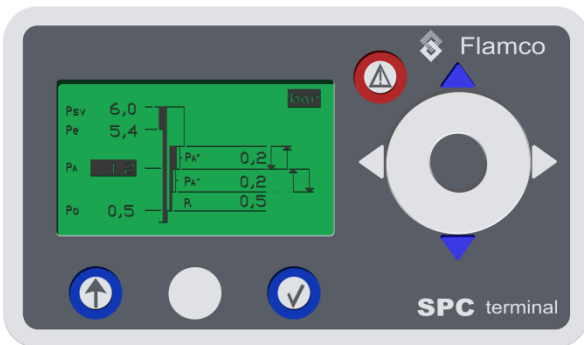

- Psv - System Safety valve Setting
- Pe - Upper Alarm Limit
- PA - System working pressure
- Po - Lower Alarm Limit
- PA+ - Upper Differential (usually 0.2 b)
- PA- - Lower Differential (usually 0.2 b)
- P+ - Low Limit Warning

Using the Scroll pad select the parameter you want to change i.e. Working pressure (PA) and Press select

As before use the middle edit button to start editing the value, the select button to confirm and the scroll button to move to the next digit.

Once set press select, either scrolls to any other parameter and repeat the above or press “Back” to confirm entries.

Start (9-9) the screen will appear as shown.

Press the back button to go to the main menu before Starting the unit

Scroll to Level (8-2) and press select

Select Top up (8-2-1) and make sure the that the tick box next to on is ticked (8-2-1-1)

Scroll to Litres Counter (8-2-1-2) and again make sure the box is ticked.

Go back to the main menu

**Degassing (8-5)\***

To activate select so the tick boxed is ticked (8-5-1)

\*Please note that if your return temperature is greater than 70°C and intermediates Vessels are being used then this option should remain disabled and at no point be reactivated.

(8-5-(2 to 6)) Scroll to desired Degassing Option usually Set to Normal or Fast in cases of first system set up, Select so its marked with a tick.

Normal Mode: pumps and valves will cycle every 60

Enter the start menu again and activate start function

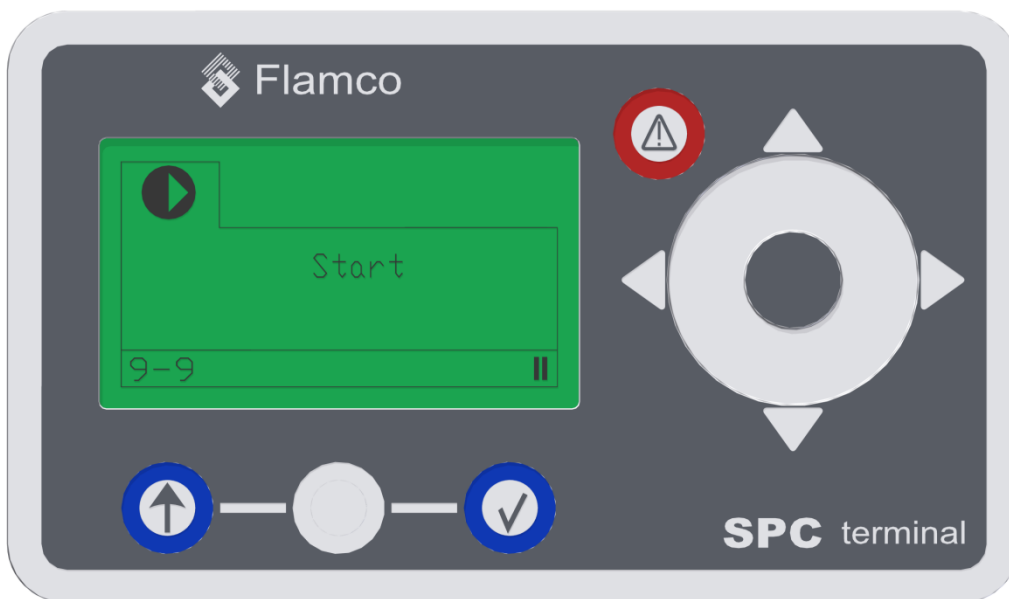

## Operating menu, options for configuration

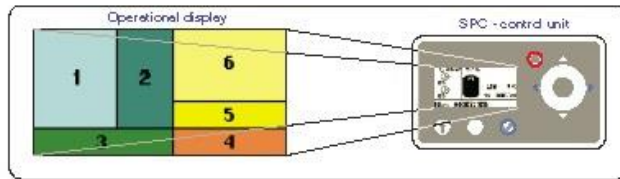

<b>1</b>	<b>4,2bar</b> (Over-) pressure, read out at pressure sensor (example)	Pump	Valve
		Pump, ON (pressure increase)	Valve, ON (pressure decrease)

<b>2</b>	<b>12 %</b> Vessel volume, read out (example)	Vessel-volume, visual	de-aeration procedure active (Menu 8-5-1 ON)
	Min. filling level ON [Error- Nr.: 19; 10]		Max. filling level ON [Error- Nr.: 11]

<b>3</b>	Top-up, self monitored			Top-up, externally monitored	
	Valve, 230V 1~	Valve, potential-free	Pumpe, 230V 1~	Signal, 230V 1~	Signal, potential-free
	Valve, 230V 1~ ON	Valve, potential-free, ON	Pumpe, 230V 1~ ON	Signal, 230V 1~ ON	Signal, potential-free, ON
	[Possible errors: error-no.: 14; 18; 22- 27]			[Possible consecutive errors: error-no.: 19; 8; 10]	
Indicated value of top-up in [hours] : [minutes] with impulse water meter in [litres].					

<b>4</b>	Water treatment, remaining volume of conditioned water in litres, (Top-up with pulse water meter required) Value 0: conditioned water used up [possible error: error-no.: 55]
----------	--

<b>5</b>	Drainage, self monitored			Drainage, externally monitored	
	Valve, 230V 1~	Valve, potential-free	Pumpe, 230V 1~	Signal, 230V 1~	Signal, potential-free
	Valve, 230V 1~ ON	Valve, potential-free, ON	Pumpe, 230V 1~ ON	Signal, 230V 1~ ON	Signal, potential-free, ON
	[Possible errors: error-no.: 28; 29; 11]			[Possible consecutive error: error-no.: 11]	
Indicated value of drainage with impulse water meter in [litres].					

<b>6</b>	De-aeration procedure		
	+: within range $P_{\text{max}}$ - : within range $P_{\text{min}}$	Gas-sensor (optional) (Menu 8-5-2 ON)	Normal cycle (Menu 8-5-4 ON)
	Temperature limiter ON, de-aeration OFF (optional)	Fast cycle (Menu 8-5-5 ON)	Sleep-mode ON (Menu 8-5-6 ON)
	Reduced cycle (1. reduction triggered by signal of sensor)	Test cycle (2. reduction triggered by signal of sensor) (Menu 8-5-3 ON)	
	Maintenance mode ON (Default: ON, when pumps have not been activated within a period of 14 days)		

## Topup Controller Overview

### Fault contacts

There are 6 volt free fault contacts which can be used for connection to a BMS system, or as a boiler interlock. These are terminals 1-12, located on the digital controller:

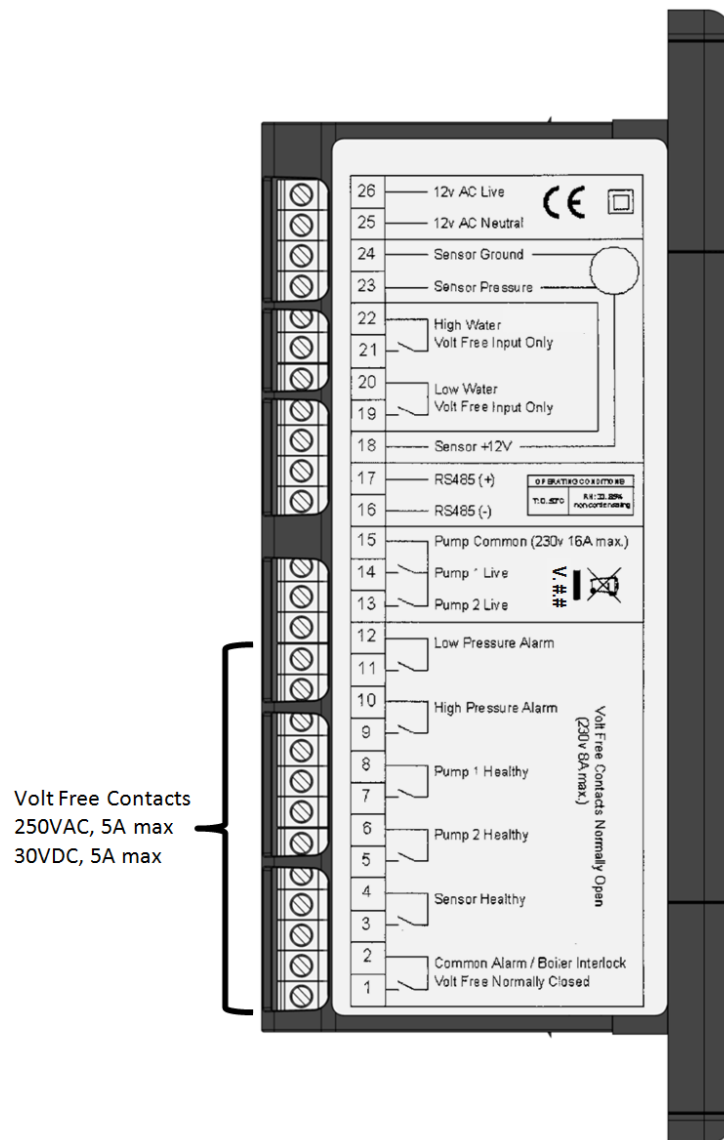

With the exception of the Common Alarm, it is possible to convert all other fault contacts to normally closed. For further information please refer to the commissioning section of this manual.



The following image shows the front of the pressurisation unit digital controller. 4 buttons are provided for programming, and an LED display which shows scrolling messages.



When the controller is first powered up, it will display the controller version number. This manual relates to controller version >8.0. If the controller is of a different version, there may be differences in the menu items available.

When in normal operation, the controller will display the current system pressure. If a fault occurs, the controller will display a fault code and produce an audible alarm.

In normal operation, the functions of the buttons are as follows:

Button	Function	
	Press	Hold
<b>SET</b>	-	Show Current System Pressure
<b>MUTE</b>	Mute Audible Alarm	Reset Unit
<b>+</b>	-	Enter Programming Menu
<b>-</b>	-	Enter Programming Menu

## Topup Controller Programming



Do not alter any settings without first understanding the implications of doing so. Incorrect settings may cause damage to the equipment, system or property.

To enter the programming menu, hold the (+) button until “enter code” appears on the screen, followed by “0000” with a flashing cursor after the first digit.

To gain access to the programming menu, one of the following codes must be entered:

Customer Code	Standard set of options	<b>2601</b>
Engineer Code (≥V6.3)	Extended set of options	<b>4706</b>

To enter the code, change the first digit with the (+) and (-) buttons, then press (SET) to move onto the next digit. Repeat for all digits, then once the correct code is shown on the display, press (SET) to enter the programming menu.

Once a correct code has been entered, the first option [COLD FILL] will appear on the screen.

Once in the menu, the value of the current menu item can be changed using the (+) and (-) buttons. Once the current value has been set, pressing the (SET) button will move on to the next option.



It is not possible to navigate backwards through the menu. To return to a previous setting in the menu, press the (SET) button repeatedly to scroll through to the end of the menu, and then re-enter the appropriate code.



If the controller loses power while in the programming menu, all changes made will be erased. To confirm all changes, the end of the menu must be reached, and the “SAVING...” message must be displayed.

## Topup Program List

The table below gives details of all menu items, in the order that they will appear:

#	Menu Item	Function	Default Value
1	<b>COLD FILL</b>	Set this figure to match the balanced pressure setting on the SPC controller	1.0 Bar
2	<b>HIGH SET</b>	The high pressure alarm setting. If the pressure in the system reaches this value, the <HIGH PRESSURE> alarm and common alarm will be activated. The recommended setting is 10% below the safety valve rating. For example, if the safety valve rating is 3 Bar, the recommended setting is 2.7 Bar. It is not possible to enter a value lower than the current [COLD FILL] value.	2.7 Bar
3	<b>LOW SET</b>	The low pressure alarm setting. If the pressure in the system falls below this value, the <LOW PRESSURE> alarm and common alarm will be activated, and the pressurisation pumps will not run. The recommended setting is 0.5 Bar below the [COLD FILL] pressure. It is not possible to enter a value higher than the current [COLD FILL] value.	0.5 Bar
4	<b>DIFFERENTIAL</b>	Not applicable on Flamcomat (PHP) Systems	0.2 Bar
5	<b>FLOOD LIMIT</b>	The maximum continuous run time for each of the topup pressurisation pumps. If a pump runs continuously for longer than this period, the pump will stop and a <FLOOD LIMIT> alarm will be activated. This is to prevent the unit from pumping large amounts of water in the event of a large leak/burst pipe. For very large systems, this may need to be increased. The value can be changed in increments of 10 minutes, to a maximum of 990.	30 MINS
6	<b>PUMP 1 COUNT</b>	The cumulative number of pump starts for pump 1. This is a cumulative counter, the value of which cannot be modified. If using the engineer's code, the counter can be reset to zero by holding the (MUTE) button.	-
7	<b>PUMP 1 HOURS</b>	The cumulative run time in hours for pump 1. This is a cumulative timer, the value of which cannot be modified. If using the engineer's code, the counter can be reset to zero by holding the (MUTE) button.	-

#	Menu Item	Function	Default Value
8	<b>PUMP 2 COUNT</b>	The cumulative number of pump starts for pump 2. This is a cumulative counter, the value of which cannot be modified. If using the engineer's code, the counter can be reset to zero by holding the (MUTE) button.	-
9	<b>PUMP 2 HOURS</b>	The cumulative run time in hours for pump 2. This is a cumulative timer, the value of which cannot be modified. If using the engineer's code, the counter can be reset to zero by holding the (MUTE) button.	-
10	<b>ALARM COUNT</b>	The cumulative number of all alarm incidents. This is a cumulative counter, the value of which cannot be modified. If using the engineer's code, the counter can be reset to zero by holding the (MUTE) button.	-
11	<b>POWER INTERRUPTED</b>	The cumulative number of power interruptions (i.e. controller turned off/ power cut). This is a cumulative counter, the value of which cannot be modified. If using the engineer's code, the counter can be reset to zero by holding the (MUTE) button.	-
12	<b>PULSE</b>	When enabled, if a pump has been inactive for 60 days, it will start and run for 2 seconds. This is to prevent the pumps from seizing.	YES
13	<b>EXCESSIVE START</b>	When enabled, if there are more than 3 individual pump runs within an 8 hour period, the unit will register an <EXCESSIVE DEMAND> alarm. Enabling this option may cause false alarms on some systems.	NO
14	<b>SERVICE</b>	When enabled, a service reminder will be displayed after 12 months from when the option was enabled. To reset the service reminder, set the value to 'NO' and exit the menu. Then, re-enter the menu and set the value to 'YES' again.	NO
15	<b>FILL SYSTEM</b>	Not applicable on Flamcomat Systems	NO



If using the customer code, the menu will end at this point. After pressing (SET) once more, the controller will display "SAVING..." and return to normal operating mode. If using the engineer's code, additional menu items will be displayed.



cause is a power

The following settings are all pre-programmed in the factory and should not need to be modified on site. If these settings appear to have been reset, the most likely spike. If this problem persists, a power filter may be required.



The following settings are for experienced engineers only. Incorrect configuration of these settings can cause the equipment not to function correctly, and may cause damage to the equipment, system or property.

#	Menu Item	Function	Default Value
16	<b>PUMPS NUMBER</b>	The number of pumps installed in the pressurisation unit. This can be set to either 1 or 2.	2
17	<b>PUMP TYPE</b>	The type of pump installed in the pressurisation unit. There are two options, which are as follows: 0 – Centrifugal Pump (Flexfiller /Digifiller/ Midi) 1 – Piston Pump (mini units only)	0
18	<b>PUMP SENSE</b>	Disabling this option will stop the controller from monitoring the pumps and generating <PUMP FAIL> faults. It is not recommended to disable this option. Please consult Flamco Technical before doing so.	YES
19	<b>SENSOR TYPE</b>	The type of pressure sensor installed in the unit. There are two options which are as follows: 1 – 1-6V Output, 0-10 Bar Range 2 – 1-6V Output, 0-16 Bar Range	1
20	<b>SPC CONTROLLER</b>	Essential setting on balanced pressurisation equipment	YES
21	<b>ADDITIVE</b>	Not required on standard Pressurisation unit	NO
22	<b>ID NUMBER</b>	A user configurable identification number. This option does not serve any functional purpose.	01
23	<b>RELAY INVERSION</b>	When enabled, all normally open fault contacts (i.e. all except the common alarm) are converted to normally closed.	NO
24	<b>OVERRUN</b>	Allows the pump to continue running for a set period of time after the required pressure has been reached. This will prevent the pumps from ‘hunting’. The value can be set from 0 – 10 seconds.	5
25	<b>PRESSURE ALARM AUTO RESET</b>	When enabled, the <HIGH PRESSURE> and <LOW PRESSURE> alarms will be cleared automatically if and when the pressure returns to normal. If disabled, the alarms must be manually reset.	YES
26	<b>CASCADE</b>	Allows the pumps to operate in duty/assist mode. After either pump starts, the other pump will start after a set period of time. This option can be set to OFF, or 5 – 30 seconds.	OFF
27	<b>BOOST</b>	When enabled, the controller will allowing the pumps to run even if the system pressure is zero.	YES
28	<b>SOLENOID CONTROL</b>	When enabled, the “high water” input is used to trigger a top up solenoid valve connected to the “sensor healthy” volt free contact. This option should only be enabled on units which utilize a solenoid valve as the means of top-up.	NO

Note:

21 = GLYCOL UNIT

28 = FLOMAT ON (>7.3 VERSION CONTROLLER)

Once commissioned, the pressurisation unit should operate without any user intervention.

Under normal operating conditions, the display will show the current system pressure in Bar.

While the unit is filling, the display will show <PUMP 1 RUN> or <PUMP 2 RUN> depending on which pump is currently running.

If the unit identifies a fault, the display will show the relevant fault code.



If the pressurisation unit is showing a fault code on the display, holding down the [SET] will cause the current system pressure to be temporarily shown on the display.

## Topup Fault Codes

The following table gives the meanings of all fault codes used on the digital controller:

Fault Code	Description	Auto/Manual Reset
LOW PRESSURE	The system pressure is below the [LOW PRESSURE] set point.	User Defined
HIGH PRESSURE	The system pressure is above the [HIGH PRESSURE] set point.	User Defined
LOW H2O	The break-tank low level float switch has been activated	Auto Reset
HIGH H2O	The break-tank high level float switch has been activated	Auto Reset
P1 FAIL P2 FAIL	The controller has detected a fault (incorrect current draw) on the respective pump	Manual Reset
P1 FLOOD LIMIT P2 FLOOD LIMIT	The respective pump has run for longer than the [FLOOD LIMIT] period	Manual Reset
ERR. 1	The signal from the pressure sensor is out of range	Manual Reset
EXCESSIVE DEMAND	There have been 4 pump starts within an 8 hour period	Manual Reset
SERVICE	The pressurisation unit is due an annual service	Manual Reset



For practical guidance on diagnosing and rectifying faults, please refer to the Troubleshooting section of this manual.

## Shutdown procedure



The pressurisation unit must be shut-down during any of the following scenarios:

- Work is being carried out on the system.
- Work is being carried out on the pressurisation unit
- The heating/cooling system is being flushed

To shut down the pressurisation unit, please follow the steps below:

1. Isolate the electrical power supply to the pressurisation unit
2. Isolate the mains water supply to the pressurisation unit
3. Isolate the pressurisation unit from the system using the isolation valves
4. Vent the internal pipework using the drain valves on the isolation valves
5. If required vent and drain the expansion vessels
6. If it is anticipated that the unit will be out of commission for more than 24 hours, it is advisable to drain the water from the break tank.

## Start-up Procedure



Attention – This procedure is for restarting the unit after being shutdown (as described above). For initial start-up and commissioning procedures, please refer to the Commissioning section of this manual.

To restart the pressurisation unit, please follow the steps below:

1. Perform a visual inspection of the unit and installation to check for signs of damage
2. Check the break-tank for debris/deposits and remove if necessary
3. Turn on the mains water supply to the pressurisation unit and allow the break tank to fill
4. Open the internal isolation valve
5. Turn on the mains power supply and wait for the controller to start
6. Depending on the conditions in the system, the unit may display one or more fault codes at this point. If this happens, please refer to the Troubleshooting section of this manual for guidance.

## Maintenance

Due to variations in operating conditions, and the varying loads placed on pressurisation units, it is not feasible to provide accurate predictions of component lifespan. The most effective method of maintenance is to inspect the pressurisation unit for early signs of component failure and take action accordingly.

The following maintenance procedures should be performed at least once a year:

### Visual Inspection

A basic visual inspection will highlight the majority of potential faults on a pressurisation unit. It is recommended to perform a visual inspection annually. However, due to the simplicity of performing these checks, frequent inspections are encouraged.

- Check the digital display for fault codes
- Check for signs of leakage (e.g. water, mineral deposits, corroded components/cabinet)
- Check the break tank overflow for signs of water discharge
- Check flexible hoses for signs of degradation (e.g. cracks)
- Check that the pressure reading on the digital display corresponds to the actual system pressure (read off another gauge)

### Interrogate Controllers

The digital controllers keep a log of the number of pump starts and total hours run for each pump, as well as the number of alarm activations and power interruptions. It is advisable to take a note of these figures when servicing the unit, as they may be helpful in diagnosing potential issues. Fields are provided in the service log for these figures.

It is advisable to scroll through all the settings (including engineers setting) and check them against the figures on the commissioning report. If there are any discrepancies, check first with on-site staff to see if the changes are deliberate. If not, reconfigure appropriately.



If settings are persistently becoming corrupted, a power filter may be required. Please refer to the Installation section of this manual for more information.



## **Test Unit Operation**

The best way to test the operation of the pressurisation unit is to drain water from the system, allowing the pressure to drop slowly. Once the pressure falls below the pump cut-in pressure ([COLD FILL] – [DIFFERENTIAL]) the pump should start. As soon as the pump starts, close the drain point and allow the system pressure to rise. Once the [COLD FILL] pressure is reached, the pump should stop.

If the unit is a twin pump model, this test should be repeated until both pumps have run and successfully re-pressurised the system.

The SPC controller will also allow trained engineers to manually activate the electrical components to verify operation and integrity. This should be done in a controlled and structured manner.

## **Check Float Valve Operation**

To test the operation of the break tank float valve, first ensure that the break tank overflow has a suitable path to drain.

Gently push down on the arm of the float valve until it starts to discharge water, then release the float valve arm. Once the arm has been released, the flow of water should stop within a few seconds.

## **Check Float Switch Operation**

To test the operation of the break tank low level float switch, reach into the break tank and gently push the float switch down into the horizontal position.

The digital controller should now display a <LOW H2O> fault.

Release the float switch and observe the display. The fault should clear after a delay of a few seconds.

## **Check Break Tank Water Condition**

Perform a visual check of the water in the break tank. If there is any dirt or debris in the water, or deposits on the sides of the tank, the tank should be drained down and cleaned.

## Topup Wiring diagram

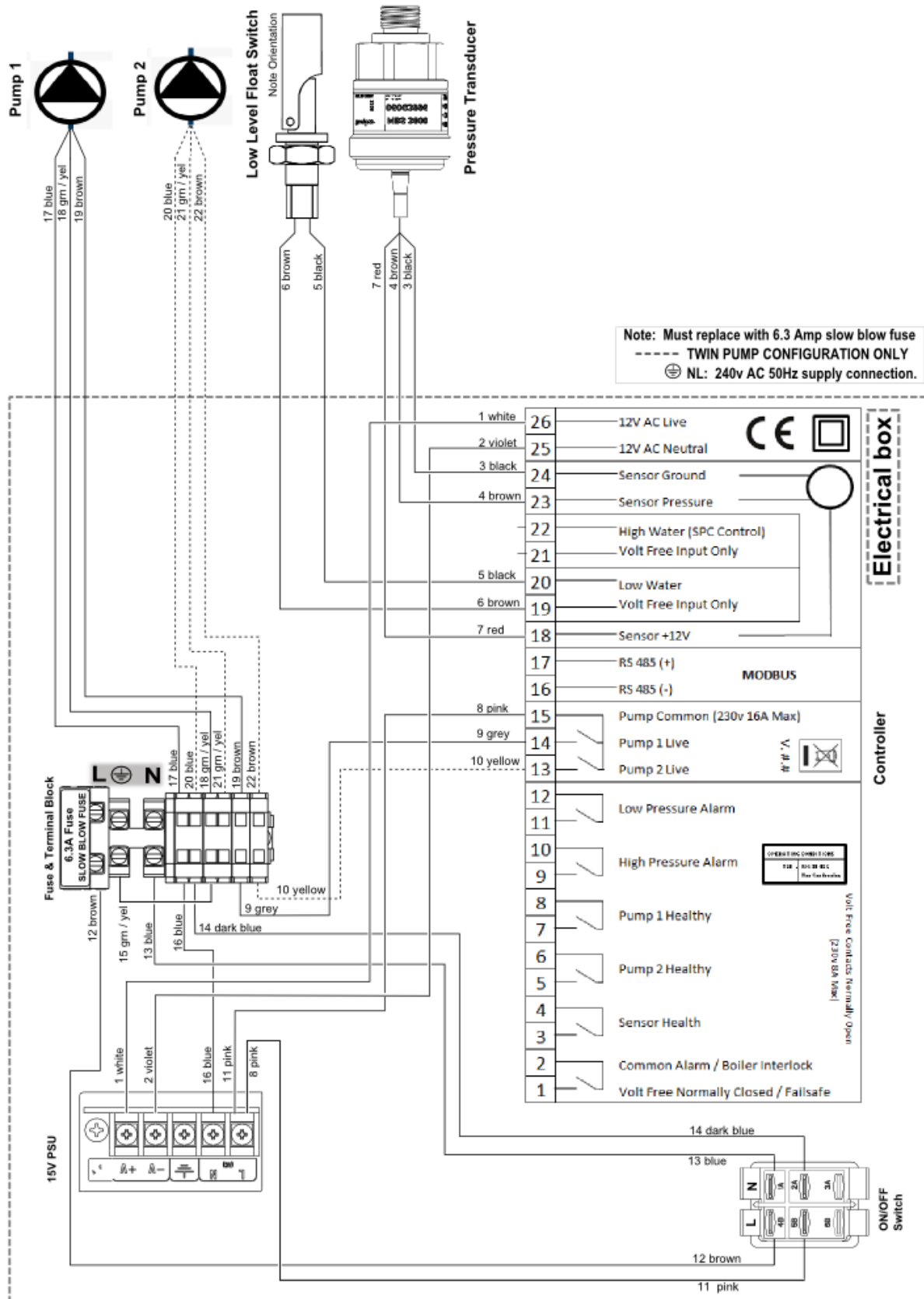

## Topup Wiring location list

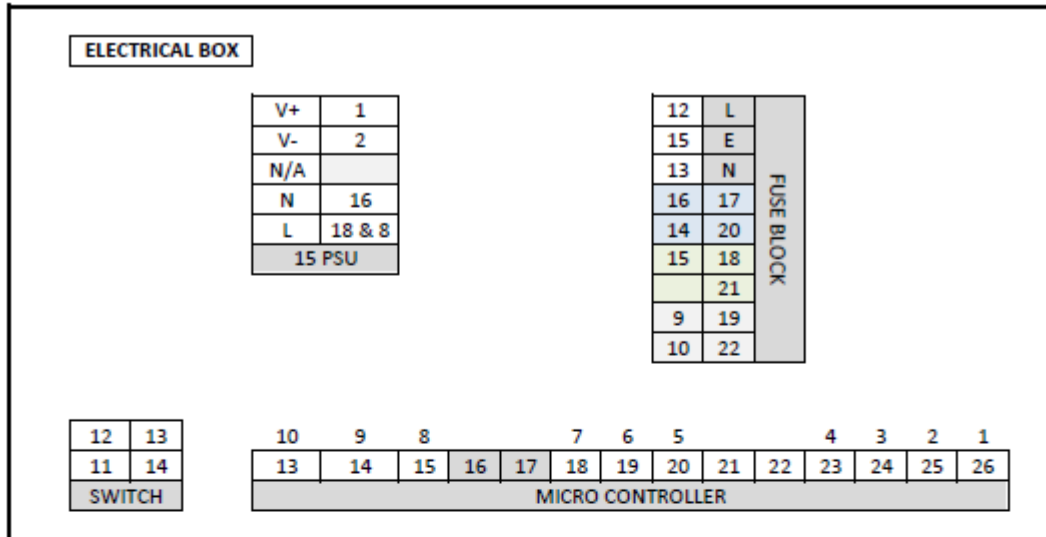

No	Colour	Connection	→	Connection	
1	White	Controller (26)		15V PSU (V +)	
2	Violet	Controller (25)		15V PSU (V -)	
3	Black	Controller (24)		Transducer	
4	Brown	Controller (23)		Transducer	
5	Black	Controller (20)		Low level Float Switch (Water Tank)	
6	Brown	Controller (19)		Low level Float Switch (Water Tank)	
7	Red	Controller (18)		Transducer	
8	Pink	Controller (15)		15V PSU (L)	
9	Grey	Controller (14)		Fuse terminal	
10	Yellow	Controller (13)		Fuse terminal	TWIN PUMP (ONLY)
11	Pink	Switch (L)		15V PSU (L)	
12	Brown	Switch (L)		Fuse terminal (Grey)	
13	Blue	Switch (N)		Fuse terminal (Grey)	
14	Dark Blue	Switch (N)		Fuse terminal (Blue)	
15	Green/Yellow	Fuse terminal		Fuse terminal (G/Y)	
16	Blue	15V PSU (N)		Fuse terminal (Blue)	
17	Blue	Pump 1		Fuse terminal (Blue)	
18	Green/Yellow	Pump 1		Fuse terminal (G/Y)	
19	Brown	Pump 1		Fuse terminal (Grey)	
20	Blue	Pump 2		Fuse terminal (Blue)	TWIN PUMP (ONLY)
21	Green/Yellow	Pump 2		Fuse terminal (G/Y)	TWIN PUMP (ONLY)
22	Brown	Pump 2		Fuse terminal (Grey)	TWIN PUMP (ONLY)

## Topup Controller Spare Parts



The drawings on the following pages show the internal components for a range of pressurisation equipment. Due to continuing development and minor design changes, some components may be changed without notice. Therefore, the drawings may not accurately reflect the current production design. If in any doubt about the compatibility of replacement parts, please contact Flamco.

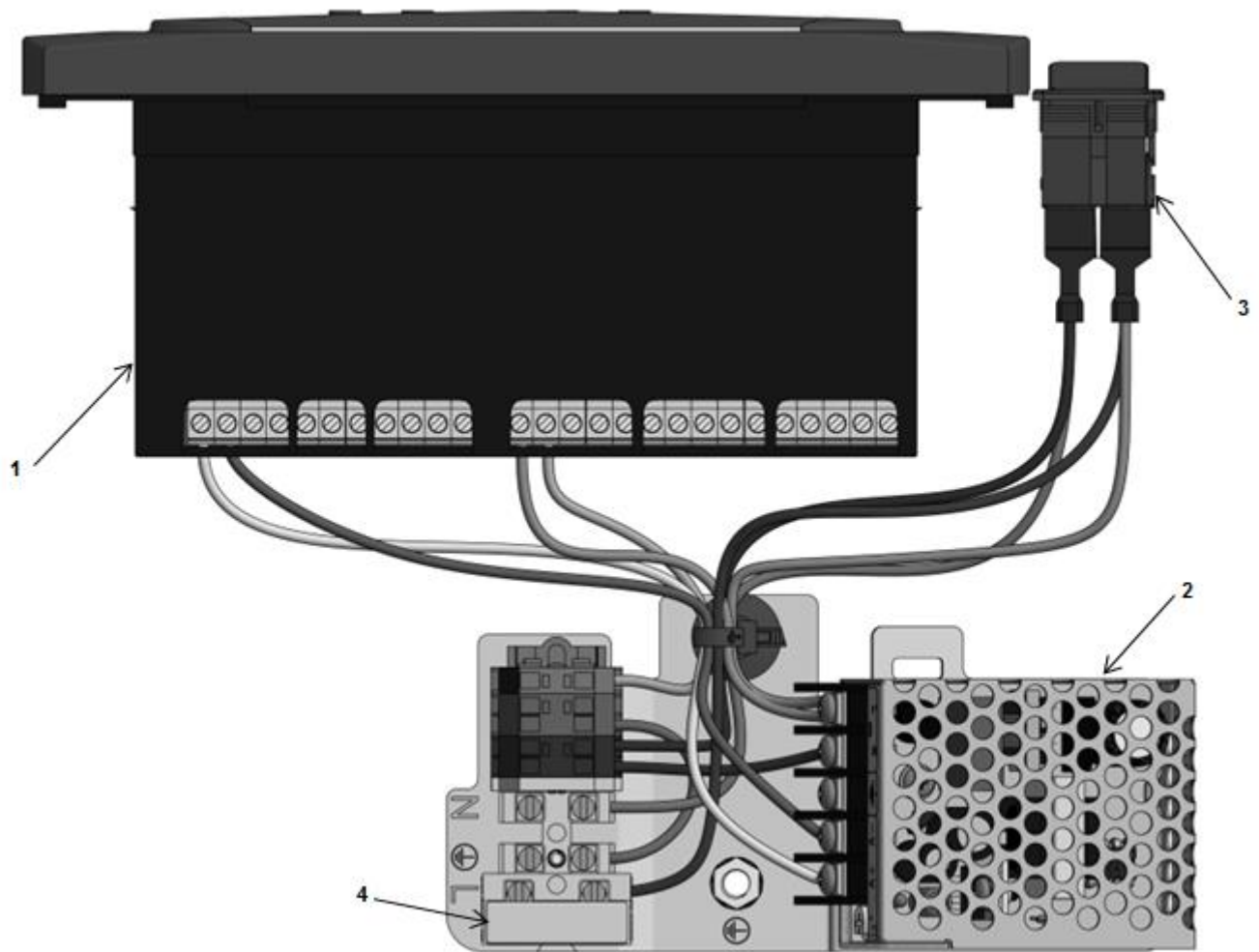

\*Image for indication only

Kit No	Kit Description	ID	Part Description	Qty
STA12500	Controller Spares Kit	1	CONTROLLER	1
		2	ELECTRICAL PLATE TWO PUMP	1
		3	ON/OFF SWITCH	1

ID Number (4) is included with part of Electrical plate as standard, this rated at 6.3 Amp.

## Topup Troubleshooting

If for any reason the pressurisation unit does not seem to be functioning correctly, please refer to the table below for a list of solutions to known problems.



If the pressurisation unit is showing a fault code on the display, holding down the [SET] button will cause the current system pressure to be temporarily shown on the display.

Symptom	Problem	Solution
LOW PRESSURE fault is displayed and the pumps do not run	The internal isolation valve within the unit is closed	Open the internal isolation valve
	The system pressure has fallen below the LOW PRESSURE set point	Increase system pressure using a filling loop, or enable the SYSTEM FILL option
	The LOW PRESSURE set point is too high	Review the system specifications
HIGH PRESSURE fault is displayed	The internal isolation valve within the unit is closed	Open the internal isolation valve
	The system pressure has risen above the HIGH PRESSURE set point	Decrease system pressure using a suitable drain point
	The expansion vessel has failed or lost its pre-charge	Check the expansion vessel pre-charge and re-charge if necessary
	The expansion vessel is undersized	Review the expansion vessel selection
	The HIGH PRESSURE set point is too low	Review the system specifications
P1 and/or P2 FLOOD LIMIT is displayed	A large amount of water has been lost from the system	Investigate cause
	The relevant pump is air-locked and not pumping water	Bleed the pump
	The unit is undersized for the system	Review unit selection
	The FLOOD LIMIT time is too short.	Consult Flamco

Symptom	Problem	Solution
P1 and/or P2 FAIL is displayed	The PUMP TYPE option is set incorrectly.	Review PUMP TYPE setting
	The relevant pump has failed	Replace pump
P2 FAIL is displayed but the unit is a single pump model	The PUMPS NUMBER option is incorrectly set to 2	Set PUMPS NUMBER to 1
LOW H2O fault is displayed	The mains water supply to the unit has been isolated	Turn on the mains water supply
	The mains pressure is poor	The fault will clear once the break tank has been re-filled
	A non-standard electrical connection has been made into terminals 19 & 20	Remove all non-standard electrical connections
	The low water float switch has failed	Replace low water float switch
	The digital controller has failed	Replace digital controller
HIGH H2O fault is displayed	A non-standard electrical connection has been made into terminals 21 & 22	Remove all non-standard electrical connections
	The digital controller has failed	Replace digital controller
Pressure reading does not match actual system pressure.	The internal isolation valve within the unit is closed	Open the internal isolation valve
	The SENSOR TYPE option is set incorrectly	Review SENSOR TYPE setting
	A non-return valve has been installed between the unit and the system	Remove non-return valve
	The pressure sensor has failed	Replace pressure sensor
ERROR 1 fault is displayed	The SENSOR TYPE option is set incorrectly	Review SENSOR TYPE setting
	The pressure sensor has failed	Replace pressure sensor

Symptom	Problem	Solution
Pump runs but does not make up pressure	The pump is air-locked and not pumping water	Bleed the pump
The pump is persistently becoming air-locked	The wrong/no flow restrictor is installed in the float valve (mini and midi units only)	Check float valve flow restrictor selection (mini and midi units only)
The break tank is overfilling and discharging water to drain or over the weir	The wrong/no flow restrictor is installed in the float valve (mini and midi units only)	Check float valve flow restrictor selection (mini and midi units only)
	The float valve position is set incorrectly	Set the float valve to its lowest possible position
	The float valve has failed	Replace float valve
	A pump non-return valve has failed	Replace non-return valve
The pump is repeatedly running in short bursts	The internal isolation valve within the unit is partially closed	Fully open the internal isolation valve
	The restriction in the connecting pipe work is too great	Increase bore/ reduce number of bends/ reduce length of connecting pipe work
	A pump non-return valve has failed	Replace non-return valve
	The expansion vessel has failed or lost its pre-charge	Check the expansion vessel pre-charge and re-charge if necessary
	The point of connection of the unit is too far away from the expansion vessel	Move unit/expansion vessel connection points closer together.
The buttons on the digital controller do not respond	The plastic housing of the digital controller has come apart and the PCB has moved	Reassemble the digital controller housing and ensure that the PCB is properly seated
The digital controller parameters are being corrupted	The controller is being subject to power spikes	Fit a suitable power filter

Symptom	Problem	Solution
The digital controller does not power up when the unit is switched on	The fuse has blown	Replace the fuse
	The mains power supply is at an incorrect voltage or frequency	Check mains power supply
	The 12V transformer has failed	Replace Transformer
	The digital controller has failed	Replace digital controller
SERVICE is displayed on the screen	The unit is due an annual service	Contact service engineer



## SPC Fault Codes

Error Number	Error, Name [Cause; effect/measure]	Menu Item Location	Default Menu Item Setting
1	Voltage spike sensor (short circuit)	-	On
2	Pressure sensor > 20mA	-	On
	Signal out of sensor range or short circuit, no pressure read-out; ball valve in cold-leg connection in incorrect position (closed) Check electrical installation, threaded round connector, sensor range (4-20mA; 16bar) cold-leg connection, change sensor if necessary and service		Automatic reset of error when fault condition is no longer seen
3	Pressure sensor < 4mA	-	On
	Signal below sensor range or not connected, no pressure read-out / Check electrical installation, threaded round connector, sensor range (4 -20 mA; 16 bar), change sensor if necessary » service		Automatic reset of error when fault condition is no longer seen
4	Volume sensor > 20mA	-	On
	Signal out of sensor range or short circuit, no volume readout / Check electronic installation, threaded round connection or sensor range FSI 1: 150-300 FSI 2: 400-800 FSI 3: 1000-2000 FSI 4:2500-5000 FSI 5: 6500-10000 Change sensor if necessary and service		Automatic reset of error when fault condition is no longer seen
5	Volume sensor < 4mA	-	On
	Signal out of sensor range or not connected, no volume read-out/ Check electrical installation, threaded round connector or sensor range; change sensor if necessary and service		Automatic reset of error when fault condition is no longer seen

8	Pressure	8-4-1	Off
	<p>Minimum working pressure ON (actual pressure): Default setting has been reached or not achieved; Ball valve in vessel or cold-leg connection in incorrect position (closed), insufficient capacity of pumps, improper system layout, or as consequence of error-no. : 10-16; 15-17; 19; 20; 22-27</p> <p>Check system lay-out, electronic installation, pumps, leaktightness of the equipment and system and ball valve; insufficient capacity diagnosed, service as required</p>		<p>PA - PA- – 0,3 bar</p> <p>Automatic reset of error when fault condition is no longer seen</p>
9	Pressure	8-4-1	Off
	<p>Maximum working pressure ON (actual pressure): Default setting has been reached or exceeded; Ball valve in cold-leg connection in incorrect position (closed), improper system layout, or as consequence of error-no. : 11; 20 Check system lay-out, electronic installation, Valve 1; 2 , particle filter, cold-leg connection, ball valve Service as required</p>		<p>PA + PA+ + 0,3 bar</p> <p>Automatic reset of error when fault condition is no longer seen</p>
10	Vessel Volume	8-4-2	Off
	<p>Minimum vessel volume ON: Default setting has been reached or not achieved; Pump motor 1; 2 is turned OFF; with top-up feature installed top-up is ON (rising level starting at 0%)/ See error-no.: 19;</p>		<p>5%</p> <p>Automatic reset of error when fault condition is no longer seen</p>
11	Vessel Volume	8-4-2	Off
	<p>Maximum vessel filling volume ON: Default setting has been reached or exceeded; Valves 1; 2 (3 is OFF) are switched OFF, Pump motor 1; 2 are not switched ON; no pressure increase or decrease; error-no.:(8) 9 can be consecutive error; improper system lay-out of initial filling / Check functioning of valves 1; 2; 3; check valve, re-calculate expansion volume, drain system water (beware of error-no.: 19);</p>		<p>96%</p> <p>Manual reset of error when fault condition is no longer seen</p>

12	Motor Circuit Switch	8-4-4	Off
	<p>Motor 1</p> <p>SPCx-lw: current-value is not reached, the temperature safety switch of the motor has been triggered due to elevated working temperatures, limiter has opened, (winding fault, power or temperature overload, no motor ventilation</p> <p>Exception: the power supply installation of the motor is after signal „motor ON“ not available or disconnected), may be followed by error-no. 8 /</p> <p>Ensure that medium and ambient temperature (module) are within admissible ranges, if necessary supply sufficient ventilation; Check electronic installation, at recurring error</p> <p>Service as required</p> <p>SPCx-hw: the default value of the motor circuit-switch has been exceeded, overcurrent (winding fault, power or temperature overload) or incorrect default setting is present, no motor ventilation, may be followed by error-no. 8 / Reassure admissible medium and ambient temperature (module), if necessary supply sufficient ventilation, check default setting and correct if necessary (name plate module: in case of DP-modules the nominal current value <math>\times \frac{1}{2}</math> corresponds with the default setting of each motor circuit-switch), at recurring error</p> <p>Service as required</p>		<p>...&lt;0,0 A</p> <p>Manual reset of error when fault condition is no longer seen</p>

13	Motor Circuit Switch	8-4-4	Off
	<p>Motor 2</p> <p>SPCx-lw: current-value is not reached, the temperature safety switch of the motor has been triggered due to elevated working temperatures, limiter has opened, (winding fault, power or temperature overload, no motor ventilation</p> <p>Exception: the power supply installation of the motor is after signal „motor ON“ not available or disconnected), may be followed by error-no. 8 /</p> <p>Ensure that medium and ambient temperature (module) are within admissible ranges, if necessary supply sufficient ventilation; Check electronic installation, at recurring error</p> <p>Service as required</p> <p>SPCx-hw: the default value of the motor circuit-switch has been exceeded, overcurrent (winding fault, power or temperature overload) or incorrect default setting is present, no motor ventilation, may be followed by error-no. 8 / Reassure admissible medium and ambient temperature (module), if necessary supply sufficient ventilation, check default setting and correct if necessary (name plate module: in case of DP-modules the nominal current value <math>\times \frac{1}{2}</math> corresponds with the default setting of each motor circuit-switch), at recurring error</p> <p>Service as required</p>		<p>...&lt;0,0 A</p> <p>Manual reset of error when fault condition is no longer seen</p>

14	Motor Circuit Switch	8-4-4	Off
	<p>Motor 3 Topup Motor</p> <p>SPCx-lw: current-value is not reached, the temperature safety switch of the motor has been triggered due to elevated working temperatures, limiter has opened, (winding fault, power or temperature overload, no motor ventilation</p> <p>Exception: the power supply installation of the motor is after signal „motor ON“ not available or disconnected), may be followed by error-no. 8 /</p> <p>Ensure that medium and ambient temperature (module) are within admissible ranges, if necessary supply sufficient ventilation; Check electronic installation, at recurring error</p> <p>Service as required</p>		<p>...&lt;0,0 A</p> <p>Manual reset of error when fault condition is no longer seen</p>
15	Motor runtime	8-4-7	Off
	<p>Motor runtime of Motor 1 exceeded:</p> <p>Default value has been reached or exceeded; suspected leakage in equipment or system, insufficient pump capacity, ball valve in vessel or cold-leg connection in incorrect position, improper system lay-out; may be followed by error-no.: 8 /</p> <p>Check system lay-out, electronic installation, pumps, leaks in equipment and installation, ball valves; insufficient pump capacity diagnosed</p> <p>Service as required</p>		<p>30 minutes</p> <p>Manual reset of error when fault condition is no longer seen</p>
16	Motor runtime	8-4-7	Off
	<p>Motor runtime of Motor 2 exceeded:</p> <p>Default value has been reached or exceeded; suspected leakage in equipment or system, insufficient pump capacity, ball valve in vessel or cold-leg connection in incorrect position, improper system lay-out; may be followed by error-no.: 8 /</p> <p>Check system lay-out, electronic installation, pumps, leaks in equipment and installation, ball valves; insufficient pump capacity diagnosed</p> <p>Service as required</p>		<p>30 minutes</p> <p>Manual reset of error when fault condition is no longer seen</p>

17	Minimum pressure limiter (optional)	8-4-5	Off
	<p>Minimum pressure limiter ON:</p> <p>The default setting at pressure limiter has been reached</p> <p>(limiter has opened); Pump motors 1; 2 and valves 1, 2, 3 are</p> <p>switched OFF (further pressure decrease will lead to vapour</p> <p>build-up in the installation) /</p> <p>Check functioning of valves 1, 2 and check valve, check</p> <p>equipment and installation for leaks (Error-no.: 8 is ON)</p>		Manual reset of error when fault condition is no longer seen
18	Level top-up pump (optional)	8-4-4	Off
	<p>Minimum volume level top-up pump ON:</p> <p>Break tank of top-up unit with insufficient volume level;</p> <p>Top-up pump is turned off, no top-up function, feed pressure is too low, feed-valve with insufficient flow rate, may be followed by error-no.: 8; 10; 19 /</p> <p>Check feed conditions</p>		Automatic reset of error when fault condition is no longer seen
19	Vessel Volume	8-4-2	Off
	<p>Minimum vessel filling volume ON:</p> <p>Default setting has been reached or not achieved;</p> <p>Pump motor 1; 2 is turned OFF, no pressurisation; May be followed by error-no.: 8; Execution without top-up feature, insufficient initial filling or as consequence of error-no. : 22-27 /</p> <p>Check top-up functioning, leaks in equipment, system lay-out; if necessary re-fill manually, beware of error-no: 11 !</p>		<p>6%</p> <p>Automatic reset of error when fault condition is no longer seen</p>

20	Bladder rupture (optional)	8-4-3	Off
	<p>Bladder rupture sensor ON:</p> <p>Water at electrodes of conductive sensors;</p> <p>Pump motors 1; 2 and valves 1; 2; 3 are switched OFF, no pressure increase / decrease or top-up;</p> <p>Error-no.: 8; 9 can be consecutive errors;</p> <p>Suspected bladder rupture / open condensate drain valve. If the opening results in water discharging continuously, the bladder should be visually checked for ruptures and leaks (Hint: inspect the vessel internally, which is part of the routine vessel inspection),</p> <p>clean the inside of the vessel</p>		Manual reset of error when fault condition is no longer seen
22	Topup	8-4-9	Off
	<p>Top-up amount too low (pulse water meter, optional)</p> <p>No pulse from pulse water meter after top-up request;</p> <p>Valve 3, Motor 3 are switched OFF, feed pressure too low, valves in incorrect position or not functioning properly, motor 3 with insufficient pump capacity;</p> <p>Exception: signal leads not installed or otherwise missing, water meter not functioning properly /</p> <p>Check electronic installation, component functioning, restore feed conditions;</p>		Manual reset of error when fault condition is no longer seen
23	Topup	8-4-9	On
	<p>Uncalled-for top-up (pulse water meter, optional)</p> <p>Pulse received from pulse water meter without request for top-up, valve 3, motor 3 are switched OFF; Equipment in in flow direction after the water meter or valve 3 is leaking or fails to close (incorrect flow direction due to non-return valve blocking) /</p> <p>Check functioning and check for leaks in the equipment</p>		Manual reset of error when fault condition is no longer seen

24	Topup	8-4-9	On
	Minimum cycle distance exceeded		Manual reset of error when fault condition is no longer seen
25	Topup	8-4-9	On
	Maximum no. of cycles per timeframe exceeded.		Manual reset of error when fault condition is no longer seen
26	Topup	8-4-9	On
	Maximum top-up cycle amount exceeded (pulse water meter, optional)		Manual reset of error when fault condition is no longer seen
27	Topup	8-4-9	On
	Maximum top-up cycle time exceeded		Manual reset of error when fault condition is no longer seen
28	Draining (Optional)	8-4-10	Off
	<p>Draining amount too low (pulse water meter, optional). No pulse from pulse water meter after draining request; valve 3.1, Motor 3.1 are switched OFF, feed pressure too low, valve in incorrect position or not functioning properly, motor 3.1 with insufficient or defective pump capacity; Exception: signal leads not installed or otherwise missing, water meter not functioning properly /</p> <p>Check electronic installation, component functioning, restore drain conditions</p>		Manual reset of error when fault condition is no longer seen



29	Draining (Optional)	8-4-10	Off
	<p>Uncalled-for draining (pulse water meter, optional)</p> <p>Pulse to pulse water meter without request for draining; valve 3.1, motor 3.1 switched OFF; equipment may leak in flow direction after the water meter or valve 3.1 fails to close (incorrect flow direction due to non-return valve being blocked) /</p> <p>Check component functioning, check for leaks in the equipment</p>		Manual reset of error when fault condition is no longer seen
30	SPCx-hw: Phase monitor (optional)	8-4-17	Off
	<p>Missing phase or sequence of phases is incorrect, motors and valves are switched OFF, no pressure increase or decrease</p> <p>Hint: the equipment supplied is installed for operation with clockwise rotating field (U/L1; V/L2; W/L3) /</p> <p>Locate phases, check power supply fuse for this equipment, switch wiring for correct sequence</p>		Automatic reset of error when fault condition is no longer seen
55	Conditioning (optional)	8-4-11	Off
	Amount of additive in conditioning exceeded		Manual reset of error when fault condition is no longer seen
56	Service 1	8-4-12	Off
	Carry out service 1 (equipment service)	365 days	Manual reset of error when fault condition is no longer seen
57	Service 2	8-4-13	Off
	Carry out service 2 (inspect vessel internally)	1825 days	Manual reset of error when fault condition is no longer seen

58	Service 3	8-4-14	Off
	Carry out service 3 (strength test vessel)	3650 days	Manual reset of error when fault condition is no longer seen
59	Service 4	8-4-15	Off
	Carry out service 4 (routine test electronic installation)	584 days	Manual reset of error when fault condition is no longer seen
53	Date, time invalid	8-4-16	Off
	Backup power for date, time is too small, not available or incorrect line entry of these data / redo or complete entry or when after complete entry error recurs » service Error OFF: self-resetting when error resolved.		Manual reset of error when fault condition is no longer seen

## Service Logs

This service log should be completed by the service engineer after each annual service.

Date		P1 COUNT	
Engineers Name		P1 HOURS	
Company		P2 COUNT	
Contact Number		P2 HOURS	
		ALARM COUNT	
		POWER INTERRUPTIONS	
Comments			
Date		P1 COUNT	
Engineers Name		P1 HOURS	
Company		P2 COUNT	
Contact Number		P2 HOURS	
		ALARM COUNT	
		POWER INTERRUPTIONS	
Comments			
Date		P1 COUNT	
Engineers Name		P1 HOURS	
Company		P2 COUNT	
Contact Number		P2 HOURS	
		ALARM COUNT	
		POWER INTERRUPTIONS	
Comments			
Date		P1 COUNT	
Engineers Name		P1 HOURS	
Company		P2 COUNT	
Contact Number		P2 HOURS	
		ALARM COUNT	
		POWER INTERRUPTIONS	
Comments			

Date		P1 COUNT	
Engineers Name		P1 HOURS	
Company		P2 COUNT	
Contact Number		P2 HOURS	
		ALARM COUNT	
		POWER INTERUPTIONS	
Comments			

Date		P1 COUNT	
Engineers Name		P1 HOURS	
Company		P2 COUNT	
Contact Number		P2 HOURS	
		ALARM COUNT	
		POWER INTERUPTIONS	
Comments			

Date		P1 COUNT	
Engineers Name		P1 HOURS	
Company		P2 COUNT	
Contact Number		P2 HOURS	
		ALARM COUNT	
		POWER INTERUPTIONS	
Comments			

Date		P1 COUNT	
Engineers Name		P1 HOURS	
Company		P2 COUNT	
Contact Number		P2 HOURS	
		ALARM COUNT	
		POWER INTERUPTIONS	
Comments			

# Appendix 1

## P&ID – Standard layout

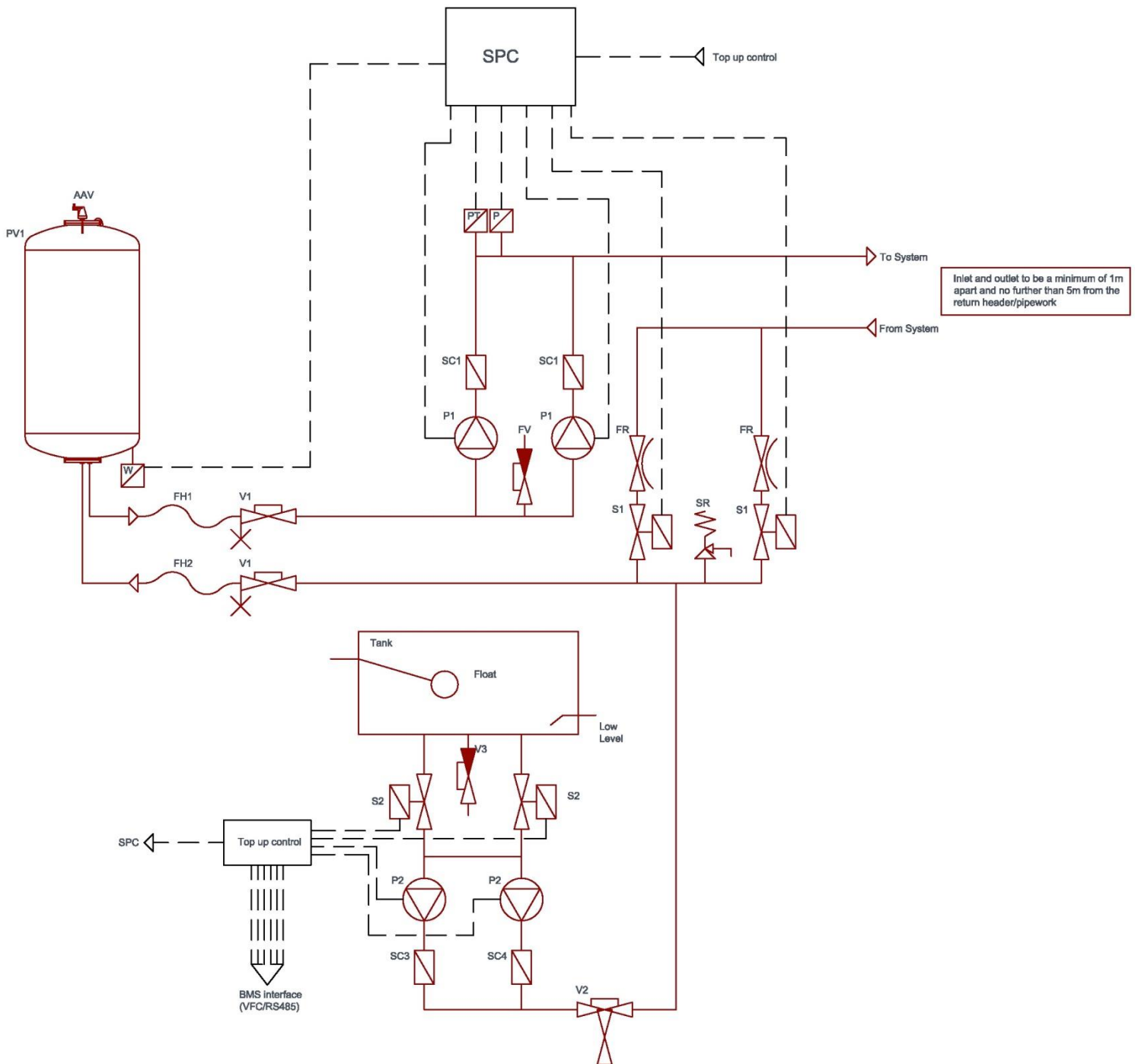

## Warranty Details

### Warranty - What Is Covered?

The Flamco warranty on equipment supplied to distribution and OEM covers manufacturing defects, under our standard terms and conditions of sale.

If the unit is identified with a manufacturing defect then no charge is made for correcting the defect.

The Flamco equipment is manufactured to order and is clearly marked, where applicable, with a unique serial number, allowing traceability to both individual model configuration and the engineer or site responsible for the build and test.

### Warranty - What Is Not Covered?

If a defect or problem has arisen as a direct result of the connected system, misuse, incorrect handling, incorrect installation or incorrect commissioning then any service visit is chargeable.

If a defect is identified as a manufacturing defect it will be addressed as described above, additional remedial works as a result of misuse, incorrect handling, incorrect installation or incorrect commissioning then the additional work is chargeable.

Installation costs and/or consequential losses are not covered by this agreement.

## Conditions of warranty

DOS - Date Of Supply

DOC - Date Of Commissioning

Equipment	Conditions	Timescale
Flamco Pressurisation Equipment inc PSD & Flamcomat	That there is an appropriate safety valve on the system protecting the equipment. That the equipment is undamaged at the time of installation. That the equipment is not exposed to adverse environmental conditions. That the equipment is stored and installed in a frost free area. That the operating and maintenance instructions are followed. That the equipment is used for the purpose for which it was designed.	18 months DOS 24 months DOC

## Contact Details

If you any queries please use contact below.

Phone: +44 (0)1744 744 744  
 Fax: +44 (0)1744 744 700  
 Email: [info@flamco.co.uk](mailto:info@flamco.co.uk) (General Enquires)  
 Email: [service@flamco.co.uk](mailto:service@flamco.co.uk) (Service Enquires)





**Sized**



**Sealed**



**Delivered**

**Flamco Limited**

Washway Lane  
St. Helens  
Merseyside WA10 6PB  
United Kingdom

**T** +44 1744 744 744

**F** +44 1744 744 700

**E** [info@flamco.co.uk](mailto:info@flamco.co.uk)