

Flextronic Bağlantı Rehberi



- TUR** **Bağlantı rehberi**
Kurulum ve işletme talimatları
- Flamconnect Ağ Geçidi
 - Analog çıkışlar
 - Dijital (Ayrık) çıkışlar
 - Bina Yönetim Sistemi (BMS) Arayüzü

İçindekiler

1. Doğru kullanım.....	2
2. Ürün açıklaması	2
2.1 Kablolama detayları.....	3
2.2 Flamconnect Ağ Geçidi	3
2.3 BMS Bağlantısı Modbus ve Bacnet	4
2.4 Ara Bağlantılı Flamco Otomatları.....	4
2.5 Analog çıkış sinyalleri (müşteri).....	4
2.6 Dijital (Ayrık) çıkış sinyalleri	5
3. Kablosuz Yapılandırması ve ayarları	5
3.1 İletişim Arayüzü ayarları.....	6
3.2 Dijital (Ayrık) çıkış programlama	6
4. Modbus eşleştirme tablosu	7
4.1 Flamcomat.....	7
4.2 FlexFiller	9
5. BacNet eşleştirme tablosu	12
5.1 Flamcomat.....	12
5.2 FlexFiller	14

Bu belge, ürün Kurulum ve İşletme talimatlarına bir ek olarak hazırlanmıştır.

Bu talimatlar özellikle Flamcomat G4'ün güvenliği, kullanımı ve işletimi açısından destek sağlamaktadır.

Çeşitli dillerde kurulum talimatları ve ek belgeler için www.flamcogroup.com/manuals adresini ziyaret edin.

Üretimle ilgili diğer bilgiler ilgili Flamco şubesinden istenebilir.

Açıklama:

-  Ana ekran
-  Ayarlar
-  Genel
-  Servis bilgisi

1. Doğru kullanım

Flextronic kontrol ünitesi bu kılavuza uygun şekilde kullanılmalıdır. Orijinal belgelerdeki uygunluk beyanı geçerliliğini korumaktadır.

2. Ürün açıklaması

Flextronic, Flamco otomatlarına yönelik genel amaçlı bir kontrol ünitesidir.

Flextronic aksesuar menüsünden etkinleştirilebilecek çok çeşitli iletişim seçeneklerine sahiptir:

1. BMS entegrasyonu için Modbus veya Bacnet protokolü üzerinden iletişim kuran Ethernet portu.
2. İşletim günlüğünün kaydedilmesi veya bir Üretici yazılımı güncellemesi yapmak için USB portu.
3. Birden çok Flamco otomatı arasında ara bağlantı için canbus portları (papatya dizimi şeklinde eşleştirilmiştir).
4. Flamco Remote Service Ağ Geçidi bağlantısı (Flamconnect) veya alternatif olarak Modbus ya da Bacnet üzerinden BMS entegrasyonu için RS-485 portları (papatya dizimi şeklinde eşleştirilmiştir).
5. Bir akıllı telefon veya bir tabletle eşleştirilmesi için kablosuz arabirim (2.400...2.485 GHz).
6. Tank seviyesi ve sistem basıncının uzaktan gösterimi için analog gerilim çıkış sinyalleri (0-10V).
7. Dijital (Ayrık) çıkış sinyalleri (250VAC, 5A maks., gerilimsiz). Bu üç port için Flextronic Alarmlar menüsünde özel hatalar ve uyarılar yapılandırılabilir.

Gösterilmeyen portlar belirli Otomat aksesuarları veya diğer işletim amaçları için tasarlanmıştır. Müşteri arayüzü veya iletişim için kullanıma yönelik değildir.

2.1 Kablolama detayları



Kurulum, veri işleme ve devreye alma çalışmaları eğitimli, vasıflı ve yetkin personel tarafından yerine getirilmelidir. İlgili ulusal standartlara, yönetmeliklere ve kurallara uyulmalıdır. Çeşitli dillerde kurulum talimatları ve ek belgeler için www.flamcogroup.com/manuals adresini ziyaret edin.

- Ek kablolar ürüne dahil değildir veya Flamco tarafından sağlanmamaktadır.
- Flamco, bükümlü tek çift blendajlı kablo kullanılmasını önermektedir.
- Sonlandırma direncinin değeri 120 Ohm'dur.
- İzin verilen maksimum kablo uzunluğu 500 m'dir.

2.2 Flamconnect Ağ Geçidi

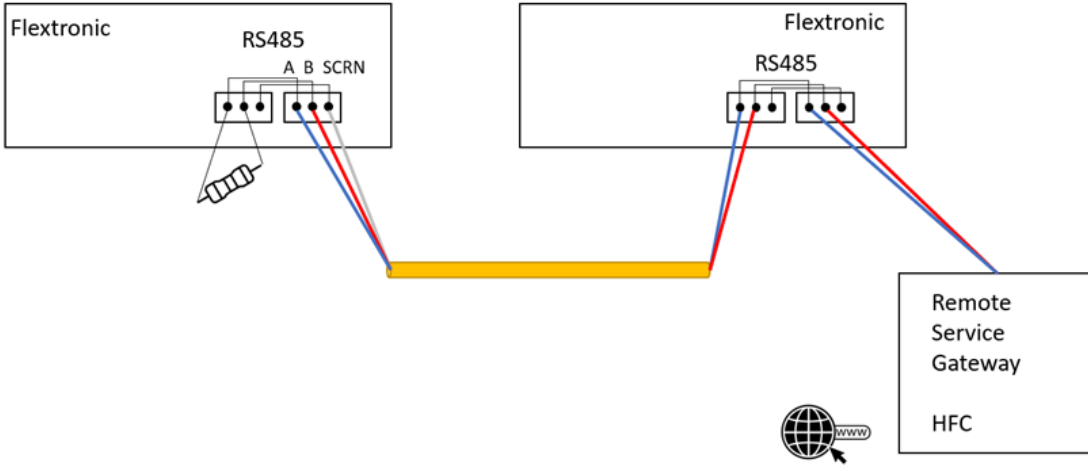

2.3 BMS Bağlantısı Modbus ve Bacnet

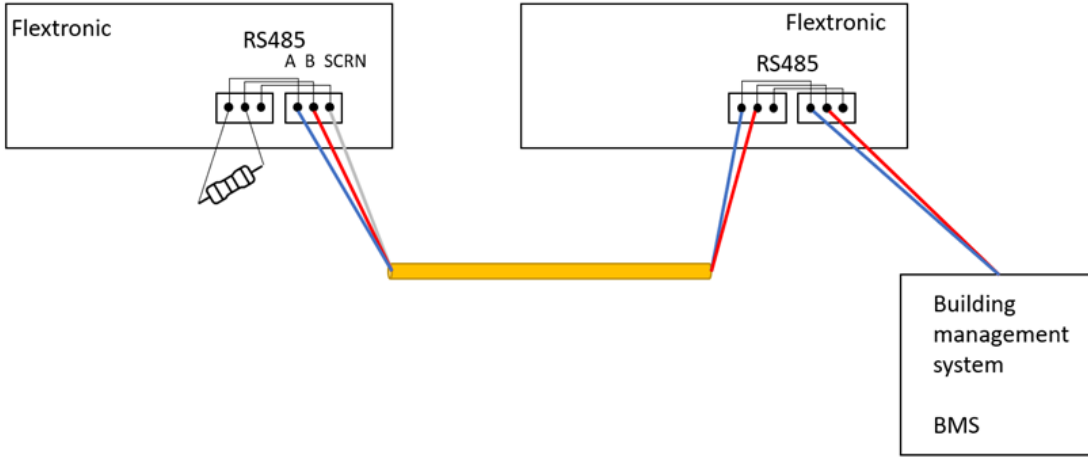

RS-485 Veri Yolu üzerinde aynı anda hem Modbus hem de Bacnet ile iletişim kurulamaz. Her iki protokolün de kullanılması gerekiyorsa protokollerden biri, Ethernet bağlantısı (IP) üzerinden çalışmalıdır. Flamconnect Remote Service Ağ Geçidini kullanırken RS485 portu, bu özellik için ayrılmıştır. Modbus veya Bacnet de gerekiyorsa bu yalnızca Ethernet bağlantısı (IP) kullanılarak yapılabilir.

2.4 Ara Bağlantılı Flamco Otomatları

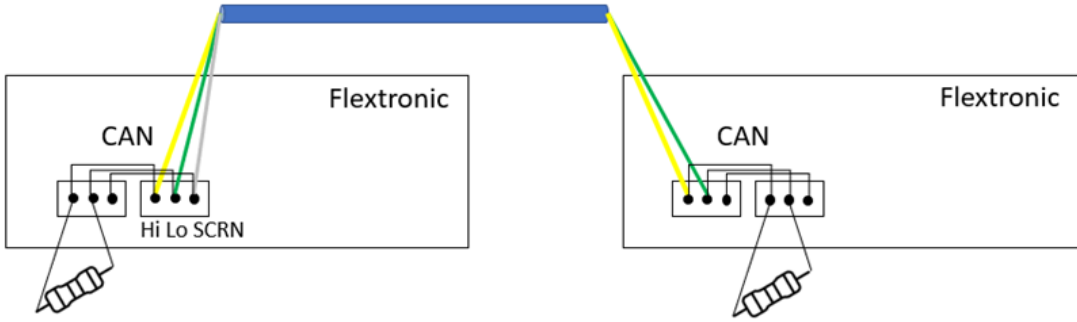

2.5 Analog çıkış sinyalleri (müşteri)

Sistem basıncı ve tank seviyesi ile ilgili gerilim analog sinyali için.

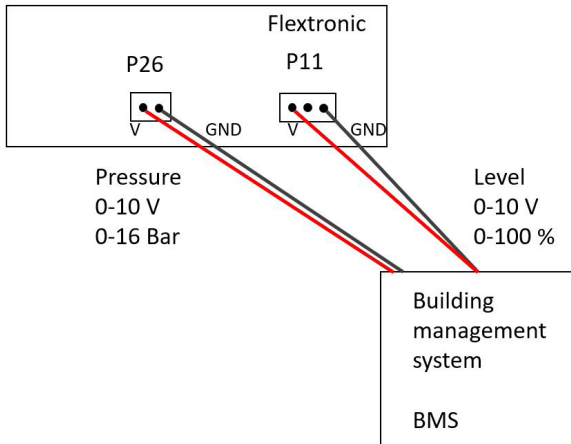

2.6 Dijital (Ayrık) çıkış sinyalleri

GUI settings:
Invert polarity: off

Specifications of VFC:
5A @ 240VAC (non-inductive)

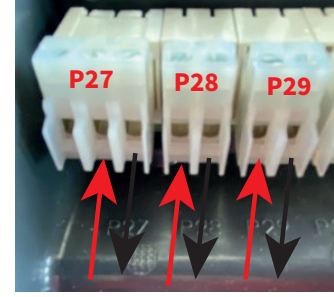
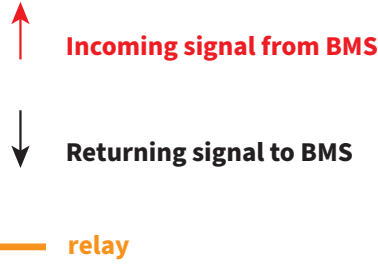

No Fault

(NO) Relay closed at (NO) OUT when controller powered up and running without error

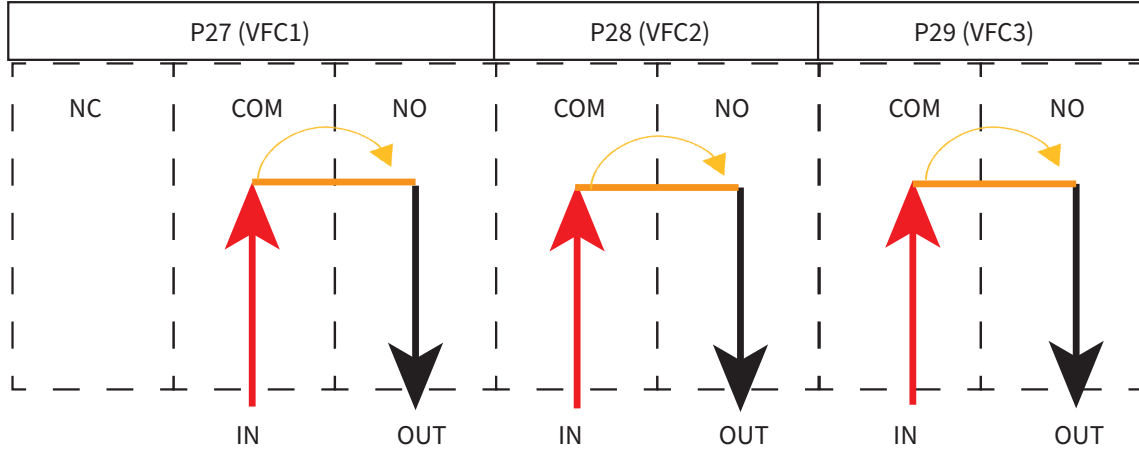

Faulty

(NO) Relay openend at (NO) OUT when controller is powered down, running with error or cable broken

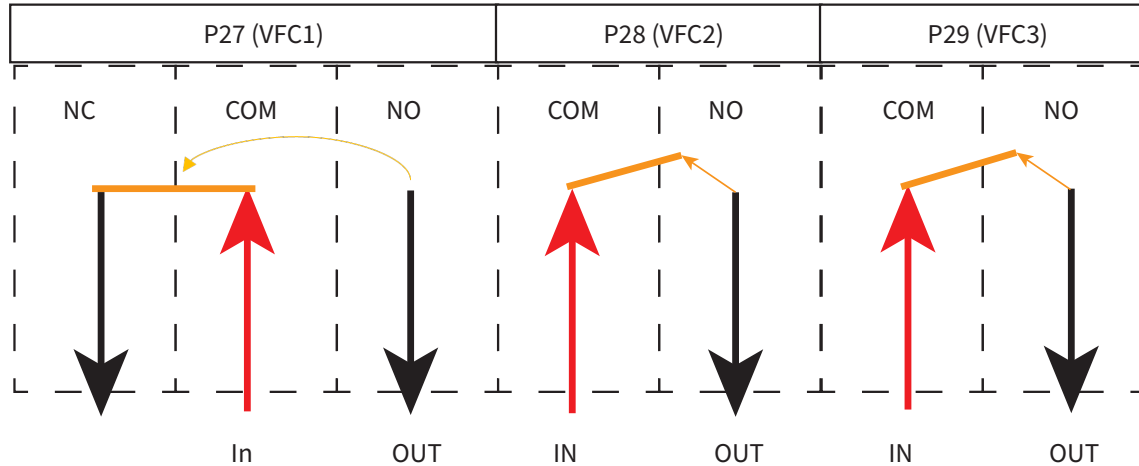



Otomat durumunu öğrenmek için. Her çıkışa özel hatalar atanabilir.
Çıkış P29, >110 °C modunun kazan kilitleme sinyalidir, bu modda alarm için kullanılamaz.

3. Kablosuz Yapılandırması ve ayarları





Yapılandırma Flamconnect Uygulaması kullanılarak yapılabilir.

Eşleştirmek için: Şifreyi girin. Otomat üzerindeki QR kodunda bulunabilir veya ekranda görüntülenebilir.



	Sistem Bilgisi	Otomat ve kontrol birimi bilgilerini görüntülemek	 
--	----------------	---	---

Müşteri arayüzlerinin ve iletişim protokollerinin yapılandırmasına kontrol birimi menüsünden erişilebilir.

	Aksesuarlar	Gelişmiş otomat aksesuarlarını etkinleştirmek	  
---	-------------	---	---

3.1 İletişim Arayüzü ayarları

Ethernet:

IP adresi	192.168.100.150
IP maskesi	255.255.255.0
IP ağ geçidi	192.168.100.1

RS-485:

Flextronic, bağımlı birimdir.

Cihaz No	seçilebilir
Baud hızı	19200
Eşlik	8-n-1





Aynı arayüze her seferinde yalnızca bir protokol atanabilir. Remote Service Ağ Geçidi bağlandığında Modbus ve Bacnet, RS-485 üzerinden kullanılamaz. Lütfen bunun yerine BMS entegrasyonu için Ethernet portunu kullanın.

3.2 Dijital (Ayrık) çıkışı programlama

Gerilimsiz dijital (ayrık) çıkışlara özel hata(lar) (hatalar ve uyarılar) atanabilir. Aynı çıkışa birden fazla hata atanırsa, atanan hatalardan herhangi biri o çıkış için etkinse çıkış etkin hâle gelir.

Hatalar Flextronic menüsünde yapılandırılabilir:

	Alarmlar	Alarm mesajını/mesajlarını ilgili gerilimsiz çıkışa/çıkışlara atamak	
--	----------	--	---

4. Modbus eşleştirme tablosu

4.1 Flamcomat

Register	Access	Name	Type	Unit	Range
0x0001	R	Current working pressure	UINT16	cbar	0..16000
0x0002	R	Current vessel level	UINT16	%	0...100
0x0003	R	Outputs state (1-on)	UINT16		Bit 0: P35 M1 Active (pump/compressor) Bit 1: P36 M2 Active (pump/compressor) Bit 2: P33 V1 active (Valve 1) Bit 3: P34 V2 active (Valve 2) Bit 4: P31 V3 Active (Valve 3/ Refill pump) Bit 8: Degassing On (Enabled)* Bit 9: Degassing mode (0-normal, 1-turbo)*
0x0004	R	Error table 1 (1-error active)	UINT16		Bit 0: Single pump/ compressor maximum run time error Bit 1: Redundant pumps/ compressor maximum run time error Bit 2: Load dependant pumps/ compressor maximum run time error Bit 3: Single pump/ compressor current error Bit 4: Pump A current error (double pump/ compressor configuration) Bit 5: Pump B current error (doublepump/ compressor configuration) Bit 6: Pumps A and B current error (double pump/ compressor configuration) Bit 7: Pump C/ compressor current error Bit 8: Self-learning valve correction error Bit 9: Self-learning pump correction error Bit 10: Pressure sensor current exceeded Bit 11: Pressure sensor no current Bit 12: Load cell current exceeded Bit 13: Load cell no current Bit 14: Pump A/ compressor power consumption too high Bit 15: Pump B/ compressor power consumption too high
0x0005	R	Error table 2 (1-error active)	UINT16		Bit 0: Pump C power consumption too high Bit 1: Maximum Runtime P35 M1 exeeded Bit 2: Maximum Runtime P36 M2 exeeded Bit 3: Maximum supplation threaded water amount exceeded Bit 4: Pump running, no decrease of water level in vessel* Bit 5: Valve open, no increase of water level in vessel* Bit 6: Maximum runtime P33 V1 exeeded Bit 7: Maximum runtime P34 V2 exeeded Bit 8: To run quick fill* Bit 9: To run system fill* Bit 10: System run in auto mode Bit 11: Quick system filling active, V to stop* Bit 12: System filling active, V to stop* Bit 13: Manual mode active, press V to start automat Bit 14: Diaphragm rupture Bit 15: Spare

Register	Access	Name	Type	Unit	Range
0x0006	R	Error table 3 (1-error active)	UINT16		Bit 0: Water level increase in vessel without Flamcomat activity* Bit 1: Water level decrease in vessel without Flamcomat activity* Bit 2: Maintenance 1 is due Bit 3: Initial fill failed Bit 4: Maximum refill time exceeded Bit 5: Maximum drain time exceeded* Bit 6: No refill flow Bit 7: Amount refill water too much Bit 8: Spare Bit 9: Spare Bit 10: Spare Bit 11: Initial fill active Bit 12: Manual initial fill active Bit 13: System fill timer expired Bit 14: Quick fill timer expired* Bit 15: Maintenance 2 is due
0x0007	R	Error table 4 (1-error active)	UINT16		Bit 0: Maintenance 3 is due Bit 1: Maintenance 4 is due Bit 2: Spare Bit 3: Spare Bit 4: Spare Bit 5: Spare Bit 6: Spare Bit 7: Spare Bit 8: Spare Bit 9: Spare Bit 10: Spare Bit 11: Spare Bit 12: Spare Bit 13: Spare Bit 14: Spare Bit 15: Spare
0x0008	R	Operational hours total	UINT16	hours	
0x0009	R	Availability (0 - No, 1 - Yes)	UINT16		Bit 0: P35 M1 pressure increase Bit 1: P36 M2 Pressure increase Bit 2: P33 V1 (pressure decrease/ compressor valve) Bit 3: P34 V2 (pressure decrease/ compressor valve) Bit 4: P31 V3 (filling pump/ valve) Bit 8: Minimum pressure limiter Bit 9: Diaphragm rupture sensor Bit 10: Maximum temperature sensor
0x000A	R	Pressure setpoint	UINT16	cbar	0..16000
0x000B	R	Minimum water level (absolute)	UINT16	%	
0x000C	R	Level refeeding On (absolute)	UINT16	%	
0x000D	R	Level refeeding Off (absolute)	UINT16	%	
0x000E	R	Minimum level alarm limit	UINT16	%	
0x000F	R	Maximum level alarm limit	UINT16	%	
0x0010	R	Nominal volume of vessel	UINT16	l	
0x0011	R	Operational mode	UINT16		0 - single mode, 1 - redundant mode 2 - load-dependent
0x0012	R	Total refill liters	UINT16	l	
0x0013	R	Total refill minutes	UINT16	minute	

* Not applicable for the Flamcomat MK-U G4

4.2 FlexFiller

Register	Access	Name	Type	Unit	Formatting
0x0000	R	SystemPressure	U16	mbar	Decimal
0x0001	R	SupplyPressure	U16	mbar	Decimal
0x0002	R	TankLevel	U16	%	Decimal
0x0003	R	VacuumPressure	U16	mbar	Decimal
0x000A	R	PressureSetpoint	U16	mbar	Decimal
0x000B	R	SafetyValveSetting	U16	mbar	Decimal
0x000C	R	Calculated_LowPressureAlarm	U16	mbar	Decimal
0x000D	R	Calculated_High PressureAlarm	U16	mbar	Decimal
0x000E	R	VesselVolume	U16	l	Decimal
0x0030	R	DigitalInput	U16	Binary	NA
0x0031	R	DigitalOutput	U16	Binary	Bit 0: P36 (Pump 2 / NC) Bit 1: P35 (Pump 1 / Direct drain valve) Bit 2: P34 (NC) Bit 3: P33 (NC) Bit 4: P32 (NC) Bit 5: P31 (Refill / Inlet valve) Bit 6: P29 (VFC 1) Bit 7: P28 (VFC 2) Bit 8: P27 (VFC 3)
0x0032	R	AccessoryPresenceMask	U16	Binary	NA
0x0033	R	AccessoryPresenceMask	U16	Binary	NA
0x0034	R	DaysToTheNextMaintenance1	U16	count	Decimal
0x0035	R	DaysToTheNextMaintenance2	U16	count	Decimal
0x0036	R	DaysToTheNextMaintenance3	U16	count	Decimal
0x0037	R	DaysToTheNextMaintenance4	U16	count	Decimal
0x0040	R	Errors_3	U16	Binary	NA (For Future Use)
0x0041	R	Errors_2	U16	Binary	NA (For Future Use)
0x0042	R	Errors_1	U16	Binary	NA (For Future Use)
0x0043	R	Errors_0	U16	Binary	Bit 0: ALR_SYSTEM_PRESSURE_LOW Bit 1: ALR_SYSTEM_PRESSURE_BELOW_MINIMUM Bit 2: ALR_SYSTEM_PRESSURE_SENSOR_OOB_LOW Bit 3: ALR_SYSTEM_PRESSURE_SENSOR_OOB_HIGH Bit 4: ALR_SYSTEM_PRESSURE_HIGH Bit 5: ALR_SYSTEM_FILL_TIMER_EXPIRED Bit 6: ALR_SAFETY_VALVE_ACTIVE Bit 7: ALR_VESSEL_PRECHARGE_LOST Bit 8: ALR_PUMP_1_OVER_CURRENT Bit 9: ALR_PUMP_2_OVER_CURRENT Bit 10: ALR_PUMP_1_NO_CURRENT Bit 11: ALR_PUMP_2_NO_CURRENT
0x0044	R	Warnings_0	U16	Binary	NA (For Future Use)
0x0045	R	Warnings_1	U16	Binary	Bit 0: WRN_SYPHON_FLUSH_DETECTED

0x0046	R	Warnings_2	U16	Binary	Bit 0: WRN_SYSTEM_FILL_ACTIVE Bit 1: WRN_SYSTEM_FILL_ON_HOLD Bit 2: WRN_ANTI_LEGIONELLA_RUNNING Bit 3: WRN_DEVICE_REBOOT Bit 4: WRN_TANK_LEVEL_SENSOR_OOB_LOW Bit 5: WRN_TANK_LEVEL_SENSOR_OOB_HIGH Bit 6: WRN_PUMP_DRY_RUN Bit 7: WRN_TANK_OVERFLOW Bit 8: WRN_MANUAL_SYSTEM_FILL Bit 9: WRN_PUMP_1_RUNTIME Bit 10: WRN_PUMP_2_RUNTIME Bit 11: WRN_ANTI_LEGIONELLA_RECOVERY Bit 12: WRN_VACUUM_PRESSURE_SENSOR_OOB_LOW Bit 13: WRN_VACUUM_PRESSURE_SENSOR_OOB_HIGH Bit 14: WRN_FILTER_FULL Bit 15: WRN_VACUUM_ERROR
0x0047	R	Warnings_3	U16	Binary	Bit 0: WRN_SYSTEM_PRESSURE_HIGH Bit 1: WRN_MAX_AMOUNT_TOPUP_WATER Bit 2: WRN_SYSTEM_PRESSURE_LOW Bit 3: WRN_NUMBER_OF_TOPUPS Bit 4: WRN_SUPPLY_PRESSURE_TOO_LOW Bit 5: WRN_SUPPLY_PRESSURE_TOO_HIGH Bit 6: WRN_SUPPLY_PRESSURE_SENSOR_OOB_LOW Bit 7: WRN_SUPPLY_PRESSURE_SENSOR_OOB_HIGH Bit 8: WRN_SYSTEM_FILL_SELF_LEARNING Bit 9: WRN_MANUAL_MODE Bit 10: WRN_MAXIMUM_TOPUP_TIME_EXCEEDED Bit 11: WRN_NO_TOPUP_FLOW Bit 12: WRN_MAINTENANCE_1_DUE Bit 13: WRN_MAINTENANCE_2_DUE Bit 14: WRN_MAINTENANCE_3_DUE Bit 15: WRN_MAINTENANCE_4_DUE
0x0050	R	OverallRuntime_H	U16	h	Decimal (Combine 0x0050&0x0051 to read the full U32 value)
0x0051	R	OverallRuntime_L	U16	h	Decimal (Combine 0x0050&0x0051 to read the full U32 value)
0x0052	R	TotalFilledVolume_H	U16	ml	Decimal (Combine 0x0052&0x0053 to read the full U32 value)
0x0053	R	TotalFilledVolume_L	U16	ml	Decimal (Combine 0x0052&0x0053 to read the full U32 value)
0x0054	R	TotalFillTime_H	U16	s	Decimal (Combine 0x0054&0x0055 to read the full U32 value)
0x0055	R	TotalFillTime_L	U16	s	Decimal (Combine 0x0054&0x0055 to read the full U32 value)
0x0056	R	ActivationsMv1_H	U16	count	Decimal (Combine 0x0056&0x0057 to read the full U32 value)
0x0057	R	ActivationsMv1_L	U16	count	Decimal (Combine 0x0056&0x0057 to read the full U32 value)
0x0058	R	ActivationsMv2_H	U16	count	Decimal (Combine 0x0058&0x0059 to read the full U32 value)
0x0059	R	ActivationsMv2_L	U16	count	Decimal (Combine 0x0058&0x0059 to read the full U32 value)
0x005A	R	RuntimeMv1_H	U16	s	Decimal (Combine 0x005A&0x005B to read the full U32 value)
0x005B	R	RuntimeMv1_L	U16	s	Decimal (Combine 0x005A&0x005B to read the full U32 value)
0x005C	R	RuntimeMv2_H	U16	s	Decimal (Combine 0x005C&0x005D to read the full U32 value)
0x005D	R	RuntimeMv2_L	U16	s	Decimal (Combine 0x005C&0x005D to read the full U32 value)
0x005E	R	ActivationsPump1_H	U16	count	Decimal (Combine 0x005E&0x005F to read the full U32 value)
0x005F	R	ActivationsPump1_L	U16	count	Decimal (Combine 0x005E&0x005F to read the full U32 value)
0x0060	R	ActivationsPump2_H	U16	count	Decimal (Combine 0x0060&0x0061 to read the full U32 value)
0x0061	R	ActivationsPump2_L	U16	count	Decimal (Combine 0x0060&0x0061 to read the full U32 value)
0x0062	R	ActivationsValve1_H	U16	count	Decimal (Combine 0x0062&0x0063 to read the full U32 value)
0x0063	R	ActivationsValve1_L	U16	count	Decimal (Combine 0x0062&0x0063 to read the full U32 value)
0x0064	R	RuntimePump1_H	U16	s	Decimal (Combine 0x0064&0x0065 to read the full U32 value)

0x0065	R	RuntimePump1_L	U16	s	Decimal (Combine 0x0064&0x0065 to read the full U32 value)
0x0066	R	RuntimePump2_H	U16	s	Decimal (Combine 0x0066&0x0067 to read the full U32 value)
0x0067	R	RuntimePump2_L	U16	s	Decimal (Combine 0x0066&0x0067 to read the full U32 value)
0x0068	R	RuntimeValve1_H	U16	s	Decimal (Combine 0x0068&0x0069 to read the full U32 value)
0x0069	R	RuntimeValve1_L	U16	s	Decimal (Combine 0x0068&0x0069 to read the full U32 value)
0x006A	R	NrOfNormalTopUps_H	U16	count	Decimal (Combine 0x006A&0x006B to read the full U32 value)
0x006B	R	NrOfNormalTopUps_L	U16	count	Decimal (Combine 0x006A&0x006B to read the full U32 value)
0x006C	R	NrOfEmergencyStops_H	U16	count	Decimal (Combine 0x006C&0x006D to read the full U32 value)
0x006D	R	NrOfEmergencyStops_L	U16	count	Decimal (Combine 0x006C&0x006D to read the full U32 value)
0x006E	R	SafetyValveActivations_H	U16	count	Decimal (Combine 0x006E&0x006F to read the full U32 value)
0x006F	R	SafetyValveActivations_L	U16	count	Decimal (Combine 0x006E&0x006F to read the full U32 value)
0x0070	R	ActivationsVfc1_H	U16	count	Decimal (Combine 0x0070&0x0071 to read the full U32 value)
0x0071	R	ActivationsVfc1_L	U16	count	Decimal (Combine 0x0070&0x0071 to read the full U32 value)
0x0072	R	ActivationsVfc2_H	U16	count	Decimal (Combine 0x0072&0x0073 to read the full U32 value)
0x0073	R	ActivationsVfc2_L	U16	count	Decimal (Combine 0x0072&0x0073 to read the full U32 value)
0x0074	R	ActivationsVfc3_H	U16	count	Decimal (Combine 0x0074&0x0075 to read the full U32 value)
0x0075	R	ActivationsVfc3_L	U16	count	Decimal (Combine 0x0074&0x0075 to read the full U32 value)

5. BacNet eşleştirme tablosu

5.1 Flamcomat

Object identifier	Access	Object Name	Type	Unit	Range
OBJECT_ANALOG_VALUE:0	R	Current working pressure	UINT16	cbar	0..16000
OBJECT_ANALOG_VALUE:1	R	Current vessel level	UINT16	%	0...100
OBJECT_ANALOG_VALUE:2	R	Outputs state (1-on)	UINT16		Bit 0: P35 M1 active (pump/ compressor) Bit 1: P36 M2 active (pump/ compressor) Bit 2: P33 V1 active (valve 1) Bit 3: P34 V2 active (valve 2) Bit 4: P31 V3 active (valve 3) Bit 8: Degassing On (Enabled)* Bit 9: Degassing mode (0-normal, 1-turbo)*
OBJECT_ANALOG_VALUE:3	R	Error table 1 (1-error active)	UINT16		Bit 0: Single pump/ compressor maximum run time error Bit 1: Redundant pumps/ compressor maximum run time error Bit 2: Load dependent pumps/ compressor maximum run time error Bit 3: Single pump/compressor current error Bit 4: Pump A current error (double pump/ compressor configuration) Bit 5: Pump B current error (double pump/ compressor configuration) Bit 6: Pumps A and B/ compressor current error (double pump c configuration) Bit 7: Pump C/ compressor current error Bit 8: Self-learning valve correction error Bit 9: Self-learning pump/ compressor correction error Bit 10: Pressure sensor current exceeded Bit 11: Pressure sensor no current Bit 12: Load cell current exceeded Bit 13: Load cell no current Bit 14: Pump A/ compressor power consumption too high Bit 15: Pump B/ compressor power consumption too high
OBJECT_ANALOG_VALUE:4	R	Error table 2 (1-error active)	UINT16		Bit 0: Pump C/ compressor power consumption too high Bit 1: Maximum runtime P35 M1 exeeded Bit 2: Maximum runtime P36 M2 exeeded Bit 3: Maximum supplation threaded water amount exceeded Bit 4: Pump/ compressor running, no decrease of water level in vessel Bit 5: Valve open, no increase of water level in vessel Bit 6: Maximum runtime P33 V1 exeeded Bit 7: Maximum runtime P34 V2 exeeded Bit 8: To run quick fill* Bit 9: To run system fill* Bit 10: System run in auto mode Bit 11: Quick system filling active, V to stop* Bit 12: System filling active, V to stop* Bit 13: Manual mode active, press V to start automat Bit 14: Diaphragm rupture Bit 15: Spare

Object identifier	Access	Object Name	Type	Unit	Range
OBJECT_ANALOG_VALUE:5	R	Error table 3 (1-error active)	UINT16		Bit 0: Water level increase in vessel without Flamcomat activity* Bit 1: Water level decrease in vessel without Flamcomat activity* Bit 2: Maintenance 1 is due Bit 3: Initial fill failed Bit 4: Maximum refill time exceeded Bit 5: Maximum drain time exceeded* Bit 6: No refill flow Bit 7: Amount refill water too much Bit 8: Spare Bit 9: Spare Bit 10: Spare Bit 11: Initial fill active Bit 12: Manual initial fill active Bit 13: System fill timer expired* Bit 14: Quick fill timer expired* Bit 15: Maintenance 2 is due
OBJECT_ANALOG_VALUE:6	R	Error table 4 (1-error active)	UINT16		Bit 0: Maintenance 3 is due Bit 1: Maintenance 4 is due Bit 2: Spare Bit 3: Spare Bit 4: Spare Bit 5: Spare Bit 6: Spare Bit 7: Spare Bit 8: Spare Bit 9: Spare Bit 10: Spare Bit 11: Spare Bit 12: Spare Bit 13: Spare Bit 14: Spare Bit 15: Spare
OBJECT_ANALOG_VALUE:7	R	Operational hours total	UINT16	hours	
OBJECT_ANALOG_VALUE:8	R	Availability (0 - No, 1 - Yes)	UINT16		Bit 0: P35 M1 pressure increase Bit 1: P36 M2 Pressure increase Bit 2: P33 V1 (pressure decrease/ compressor valve) Bit 3: P34 V2 (pressure decrease/ compressor valve) Bit 4: P31 V3 (filling pump/ valve) Bit 8: Minimum pressure limiter Bit 9: Diaphragm rupture sensor Bit 10: Maximum temperature sensor
OBJECT_ANALOG_VALUE:9	R	Pressure setpoint	UINT16	cbar	0..16000
OBJECT_ANALOG_VALUE:10	R	Minimum water level (absolute)	UINT16	%	
OBJECT_ANALOG_VALUE:11	R	Level refeeding On (absolute)	UINT16	%	
OBJECT_ANALOG_VALUE:12	R	Level refeeding Off (absolute)	UINT16	%	
OBJECT_ANALOG_VALUE:13	R	Minimum level alarm limit	UINT16	%	
OBJECT_ANALOG_VALUE:14	R	Maximum level alarm limit	UINT16	%	
OBJECT_ANALOG_VALUE:15	R	Nominal volume of vessel	UINT16	l	
OBJECT_ANALOG_VALUE:16	R	Operational mode	UINT16		0 - single mode, 1 - redundant mode 2 - load-dependent
OBJECT_ANALOG_VALUE:17	R	Total refill liters	UINT16	l	
OBJECT_ANALOG_VALUE:18	R	Total refill minutes	UINT16	minute	

* Not applicable for the Flamcomat MK-U G4

5.2 FlexFiller

Object ID	Access	Object name	Type	Unit	Formatting
OBJECT_ANALOG_VALUE:0	R	"alarms"	U64	Binary	Bit 0: ALR_SYSTEM_PRESSURE_LOW Bit 1: ALR_SYSTEM_PRESSURE_BELOW_MINIMUM Bit 2: ALR_SYSTEM_PRESSURE_BELOW_MINIMUM Bit 3: ALR_SYSTEM_PRESSURE_SENSOR_OOB_HIGH Bit 4: ALR_SYSTEM_PRESSURE_HIGH Bit 5: ALR_SYSTEM_FILL_TIMER_EXPIRED Bit 6: ALR_SAFETY_VALVE_ACTIVE Bit 7: ALR_VESSEL_PRECHARGE_LOST Bit 8: ALR_PUMP_1_OVER_CURRENT Bit 9: ALR_PUMP_2_OVER_CURRENT Bit 10: ALR_PUMP_1_NO_CURRENT Bit 11: ALR_PUMP_2_NO_CURRENT
OBJECT_ANALOG_VALUE:1	R	"warnings"	U64	Binary	Bit 0: WRN_SYSTEM_PRESSURE_HIGH Bit 1: WRN_MAX_AMOUNT_TOPUP_WATER Bit 2: WRN_SYSTEM_PRESSURE_LOW Bit 3: WRN_NUMBER_OF_TOPUPS Bit 4: WRN_SUPPLY_PRESSURE_TOO_LOW Bit 5: WRN_SUPPLY_PRESSURE_TOO_HIGH Bit 6: WRN_SUPPLY_PRESSURE_SENSOR_OOB_LOW Bit 7: WRN_SUPPLY_PRESSURE_SENSOR_OOB_HIGH Bit 8: WRN_SYSTEM_FILL_SELF_LEARNING Bit 9: WRN_MANUAL_MODE Bit 10: WRN_MAXIMUM_TOPUP_TIME_EXCEEDED Bit 11: WRN_NO_TOPUP_FLOW Bit 12: WRN_MAINTENANCE_1_DUE Bit 13: WRN_MAINTENANCE_2_DUE Bit 14: WRN_MAINTENANCE_3_DUE Bit 15: WRN_MAINTENANCE_4_DUE Bit 16: WRN_SYSTEM_FILL_ACTIVE Bit 17: WRN_SYSTEM_FILL_ON_HOLD Bit 18: WRN_ANTI_LEGIONELLA_RUNNING Bit 19: WRN_DEVICE_REBOOT Bit 20: WRN_TANK_LEVEL_SENSOR_OOB_LOW Bit 21: WRN_TANK_LEVEL_SENSOR_OOB_HIGH Bit 22: WRN_PUMP_DRY_RUN Bit 23: WRN_TANK_OVERFLOW Bit 24: WRN_MANUAL_SYSTEM_FILL Bit 25: WRN_PUMP_1_RUNTIME Bit 26: WRN_PUMP_2_RUNTIME Bit 27: WRN_ANTI_LEGIONELLA_RECOVERY Bit 28: WRN_VACUUM_PRESSURE_SENSOR_OOB_LOW Bit 29: WRN_VACUUM_PRESSURE_SENSOR_OOB_HIGH Bit 30: WRN_FILTER_FULL Bit 31: WRN_VACUUM_ERROR Bit 32: WRN_SYPHON_FLUSH_DETECTED
OBJECT_ANALOG_VALUE:2	R	"current system pressure"	U16	mbar	Decimal
OBJECT_ANALOG_VALUE:3	R	"current supply pressure"	U16	mbar	Decimal
OBJECT_ANALOG_VALUE:4	R	"current tank level"	U16	%	Decimal
OBJECT_ANALOG_VALUE:5	R	"current vacuum pressure"	U16	mbar	Decimal
OBJECT_ANALOG_VALUE:6	R	"pressure setpoint"	U16	mbar	Decimal
OBJECT_ANALOG_VALUE:7	R	"safety valve setting"	U16	mbar	Decimal
OBJECT_ANALOG_VALUE:8	R	"low pressure alarm limit"	U16	mbar	Decimal
OBJECT_ANALOG_VALUE:9	R	"high pressure alarm limit"	U16	mbar	Decimal

OBJECT_ANALOG_VALUE:10	R	"vessel volume"	U16	l	Decimal
OBJECT_ANALOG_VALUE:11	R	"digital input"	U16	Binary	NA
OBJECT_ANALOG_VALUE:12	R	"digital output"	U16	Binary	Bit 0: P36 (Pump 2 / NC) Bit 1: P35 (Pump 1/MV1 topup valve) Bit 2: P34 (NC) Bit 3: P33 (NC) Bit 4: P32 (NC) Bit 5: P31 (Inlet valve/MV2 Drain Valve) Bit 6: P29 (VFC 1) Bit 7: P28 (VFC 2) Bit 8: P27 (VFC 3)
OBJECT_ANALOG_VALUE:13	R	"accessories"	U32	Binary	NA
OBJECT_ANALOG_VALUE:14	R	"days to next maintenance 1"	U16	count	Decimal
OBJECT_ANALOG_VALUE:15	R	"days to next maintenance 2"	U16	count	Decimal
OBJECT_ANALOG_VALUE:16	R	"days to next maintenance 3"	U16	count	Decimal
OBJECT_ANALOG_VALUE:17	R	"days to next maintenance 4"	U16	count	Decimal
OBJECT_ANALOG_VALUE:18	R	"overall runtime"	U32	h	Decimal
OBJECT_ANALOG_VALUE:19	R	"total filled volume"	U32	ml	Decimal
OBJECT_ANALOG_VALUE:20	R	"total fill time"	U32	s	Decimal
OBJECT_ANALOG_VALUE:21	R	"activations MV1"	U32	count	Decimal
OBJECT_ANALOG_VALUE:22	R	"activations MV2"	U32	count	Decimal
OBJECT_ANALOG_VALUE:23	R	"runtime MV1"	U32	s	Decimal
OBJECT_ANALOG_VALUE:24	R	"runtime MV2"	U32	s	Decimal
OBJECT_ANALOG_VALUE:25	R	"activations Pump1"	U32	count	Decimal
OBJECT_ANALOG_VALUE:26	R	"activations Pump2"	U32	count	Decimal
OBJECT_ANALOG_VALUE:27	R	"activations Valve1"	U32	count	Decimal
OBJECT_ANALOG_VALUE:28	R	"runtime Pump1"	U32	s	Decimal
OBJECT_ANALOG_VALUE:29	R	"runtime Pump2"	U32	s	Decimal
OBJECT_ANALOG_VALUE:30	R	"runtime Valve1"	U32	s	Decimal
OBJECT_ANALOG_VALUE:31	R	"nrOfNormalTopUps"	U32	count	Decimal
OBJECT_ANALOG_VALUE:32	R	"nrOfEmergencyStops"	U32	count	Decimal
OBJECT_ANALOG_VALUE:33	R	"safetyValveActivations"	U32	count	Decimal
OBJECT_ANALOG_VALUE:34	R	"activationsVfc1"	U32	count	Decimal
OBJECT_ANALOG_VALUE:35	R	"activationsVfc2"	U32	count	Decimal
OBJECT_ANALOG_VALUE:36	R	"activationsVfc3"	U32	count	Decimal

İletişim

Hollanda

hydronic flow control
+31 36 520 62 300
info@flamcogroup.com
www.flamcogroup.com

Belçika

hydronic flow control
+32 2 371 01 67
info@flamco.be

Danimarka

Flamco Denmark
+45 44 94 02 07
info@flamco.dk

Fransa

hydronic flow control
+33 4 78 78 16 00
info@flamco.fr

Macaristan

Flamco Kft
+36 23 880981
info@flamco.hu

Rusya Federasyonu

ООО „Майбес РУС“
+7 495 727 20 26
moscow@flamcogroup.ru

İsviçre

Flamco AG
+41 41 854 30 50
info@flamco.ch

Çin

Flamco Heating Accessories
(Changshu) Ltd, Co.
+86 512 528 417 31
yecho@flamco.com.cn

Estonya

Flamco Baltic
+372 568 838 38
info@flamco.ee

Almanya

Meibes System-Technik GmbH
+49 342 927 130
info@meibes.com

İtalya

Flamco Italy
+39 030 258 6005
flamco-italia@flamcogroup.com

Slovakya

Flamco SK s.r.o.
+421 475 634 043
info@meibes.sk

Birleşik Arap Emirlikleri

Flamco Middle East
+971 4 8819540
info@flamco-gulf.com

Çek Cumhuriyeti

Flamco CZ s.r.o.
+420 284 00 10 81
info@meibes.cz

Finlandiya

Flamco Finland
+358 10 320 99 90
info@flamco.fi

Almanya

Flamco GmbH
+49 2104 80006 20
info@flamco.de

Polonya

Flamco Meibes Sp. z o.o.
+48 65 529 49 89
info@flamco.pl

İsveç

Flamco Sverige
+46 50 042 89 95
vvs@flamco.se

Birleşik Krallık

Flamco Limited
+44 17 447 447 44
info@flamco.co.uk

Flamco B.V.
Fort Blauwkapel 1
1358 DB Almere
the Netherlands
+31 33 299 75 00
info@flamcogroup.com
www.flamcogroup.com

Telif hakkı Flamco B.V., Almere, Hollanda. Bu yayının hiçbir bölümü açık izin alınmadan ve kaynak belirtilmeden hiçbir şekilde çoğaltılamaz veya yayınlanamaz. Listelenen veriler yalnızca Flamco ürünleri için geçerlidir. Flamco B.V. teknik bilgilerin yanlış kullanımı, uygulanması veya yorumlanması konusunda hiçbir sorumluluk kabul etmez. Flamco B.V., teknik değişiklikler yapma hakkını saklı tutar.

man_flextronic_connectivity_guide_tur_2023-11